

**iCOM**

**INSTRUCTION MANUAL**

144MHz FM TRANSCEIVER

**IC-02N**

**Icom Inc.**

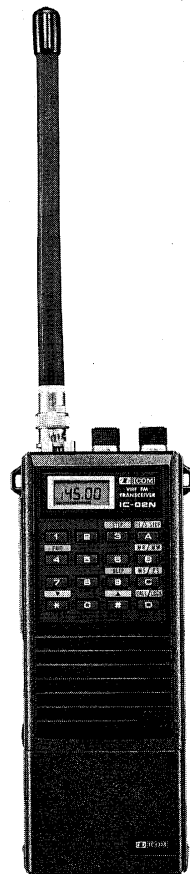

---

## FOREWORD

---

Thank you for purchasing the **IC-02N 144 MHz FM TRANSCEIVER**. This transceiver is designed for those who require top-grade quality, performance and outstanding reliability under the most demanding conditions.

---

## IMPORTANT

---

**READ ALL INSTRUCTIONS** carefully and completely before using the transceiver.

**SAVE THIS INSTRUCTION MANUAL.** This instruction manual contains important safety and operating instructions.

---

## EXPLICIT DEFINITIONS

---

The following explicit definitions apply to this manual.

Word	Definition
<b>CAUTION</b>	Equipment damage may occur.
<b>NOTE</b>	If disregarded, inconvenience only. No personal injury, risk of fire or electric shock.

---

## CAUTIONS

---

**NEVER** connect the transceiver to an AC outlet or to a power source of more than 16 V DC. These connections will ruin the transceiver.

**NEVER** connect the transceiver to a power source using reverse polarity. This connection will ruin the transceiver.

**NEVER** allow children to touch the transceiver.

If memory channel information is erased, ask your Icom Dealer or Service Center for lithium backup battery replacement. **NEVER** replace it yourself.

**AVOID** using or placing the transceiver in areas with temperatures below  $-10^{\circ}\text{C}$  or above  $+60^{\circ}\text{C}$ .

**AVOID** placing the transceiver in direct sunlight.

**BE CAREFUL!** When transmitting for a long time with high output power, the rear panel will become hot.

The use of non-Icom battery packs and chargers may impair transceiver performance and invalidate the warranty.

# TABLE OF CONTENTS

<b>1 PRE-OPERATION</b> .....	<b>1-2</b>	■ Transmitting .....	<b>9</b>
<b>2 PANEL DESCRIPTION</b> .....	<b>3-6</b>	■ Output power .....	<b>9</b>
■ Front and side panels .....	<b>3</b>	<b>5 MEMORY OPERATION</b> .....	<b>10</b>
■ Top panel .....	<b>4</b>	■ Special functions .....	<b>10</b>
■ Keyboard .....	<b>5</b>	■ Call channel .....	<b>10</b>
■ Function display .....	<b>6</b>	■ Programming .....	<b>10</b>
<b>3 FREQUENCY SETTING</b> .....	<b>7-8</b>	■ Memory recall .....	<b>10</b>
■ Using digit keys .....	<b>7</b>	<b>6 SCAN OPERATION</b> .....	<b>11-12</b>
■ Using $\Delta$ / $\nabla$ keys .....	<b>7</b>	■ Scan types .....	<b>11</b>
■ Tuning step .....	<b>7</b>	■ Programmed scan .....	<b>11</b>
■ Lock function .....	<b>8</b>	■ Memory scan .....	<b>11</b>
■ Display lighting .....	<b>8</b>	■ Priority watch .....	<b>12</b>
■ Beep tone .....	<b>8</b>	<b>7 TROUBLESHOOTING</b> .....	<b>13</b>
<b>4 RECEIVING AND TRANSMITTING</b> .....	<b>9</b>	<b>8 SPECIFICATIONS</b> .....	<b>14</b>
■ Receiving .....	<b>9</b>	<b>9 OPTIONS</b> .....	<b>15-16</b>

## UNPACKING

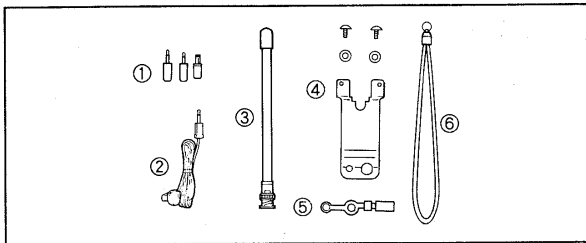

### Included accessories:

	<b>Qty.</b>
① Earphone plug, microphone plug and DC plug .....	1 set
② Earphone .....	1
③ Flexible antenna (FA-2) .....	1
④ Belt clip and screws .....	1 set
⑤ Rainproof cap .....	1
⑥ Handstrap .....	1

The BP-4 BATTERY CASE is attached to the transceiver.

## ◇ Battery case removal

Push and hold the [RELEASE] button upwards, then slide the battery case to the right with the transceiver facing you.

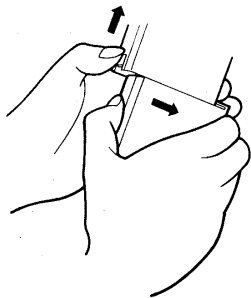

## ◇ Dry cell battery installation

Hold the sides of the battery case and push down on the top aluminum panel.

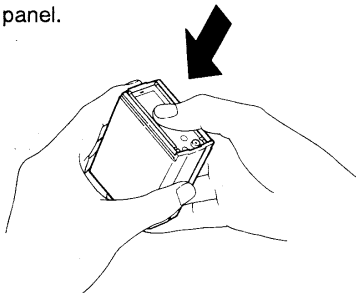

Install AA (R6) × 6 dry cell batteries into the battery holder.

- Be careful of the polarity of the batteries.

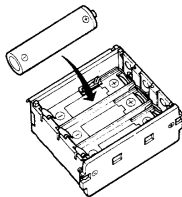

## ◇ Battery case attachment

Slide the battery holder into the battery case.

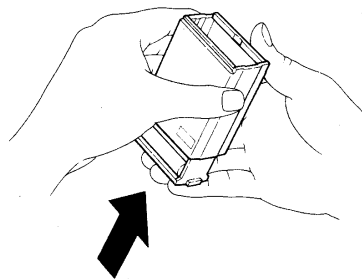

To attach the battery case to the transceiver, mate the notched ends of the transceiver and the battery case, and slide until a click sounds.

### ◆ Rainproof cap and flexible antenna

Attach the rain proofcap to protect the jacks from dust and rain.

Connect the supplied flexible antenna into the antenna connector and rotate the antenna.

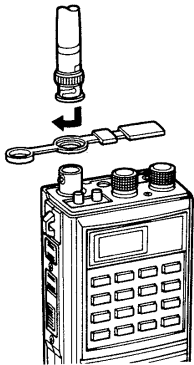

**CAUTION:** Transmitting without an antenna may damage the transceiver.

### ◆ Belt clip

The belt clip allows you to hang the transceiver from your belt.

Attach the belt clip on the rear panel using the supplied screws and plastic washers.

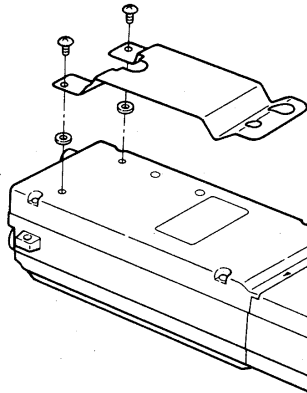

### ◆ Handstrap

Spread open and slide the ring of the handstrap over the projecting loop on the side of the transceiver.

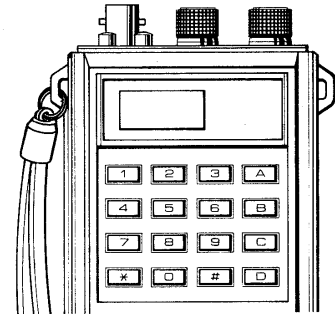

# 2

## PANEL DESCRIPTION

### ■ Front and side panels

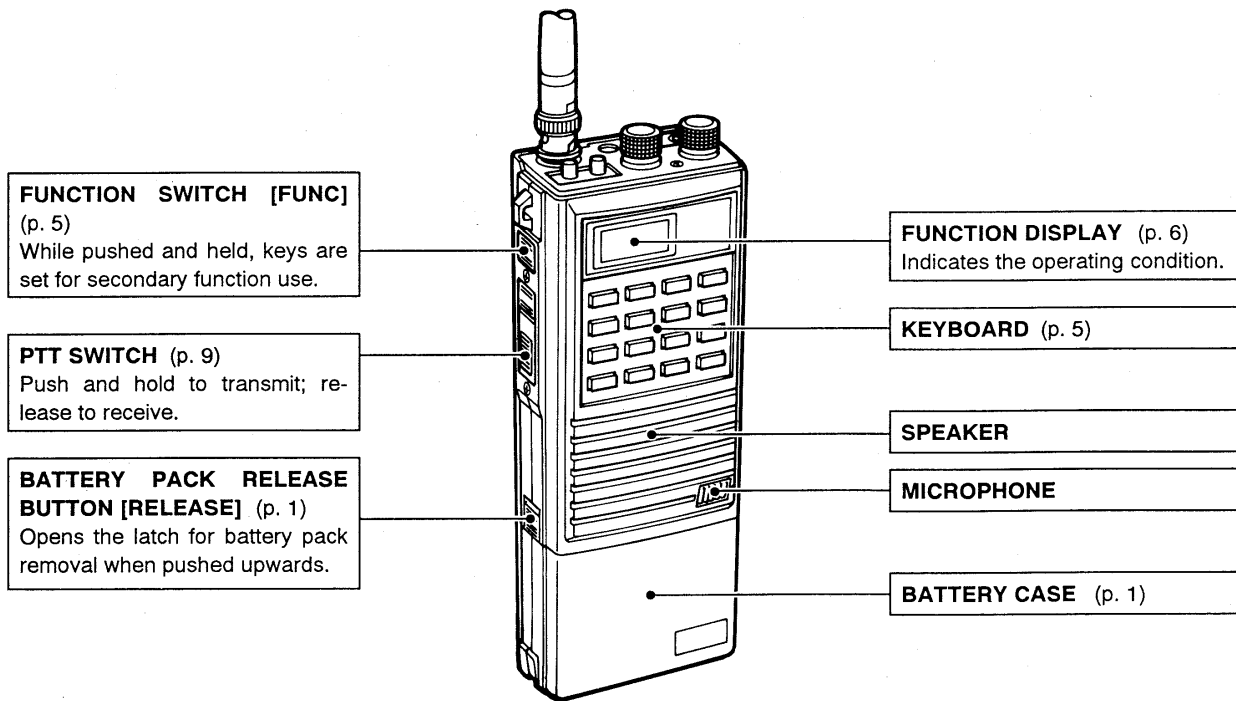

## Top panel

### ANTENNA CONNECTOR

Connects the supplied antenna.  
(p. 2)

### EXTERNAL DC POWER JACK [DC IN]

- Connects an optional wall charger or external DC power source for BP-3, BP-7, BP-8 and BP-70 charging. (p. 15)
- Connects an external DC power source for operation. (p. 15)

### Supplied DC plug polarity

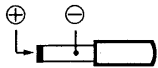

### LIGHT SWITCH

Turns the function display lighting ON and OFF. (p. 8)

### HIGH/LOW SWITCH [HIGH/LOW]

Selects high or low output power.  
(p. 9)

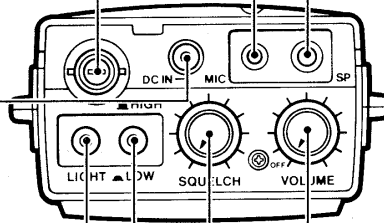

### EXTERNAL MICROPHONE AND SPEAKER JACKS [MIC], [SP]

- Connect an optional speaker-microphone or headset, if required. (p. 16)
- Connect supplied earphone, if required.

### External connection

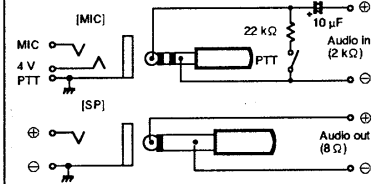

### VOLUME CONTROL [VOLUME]



Turns power ON and OFF and adjusts the audio level. (pgs. 7, 9)

### SQUELCH CONTROL [SQUELCH]

Varies the squelch threshold point for noise mute. (p. 9)

## 2 PANEL DESCRIPTION

### Keyboard

Key	Function	Secondary function (While pushing [FUNC])	Key	Function	Secondary function (While pushing [FUNC])
1	- Selects the frequency in VFO mode. (p. 7) - Selects a memory channel in MEMORY mode. (p. 10)	No function.		- Decreases the frequency in VFO mode. (p. 7) - Decreases the channel number in MEMORY mode. (p. 10)	No function.
2		No function.			
STEP 3		Selects a tuning step. (p. 7)	CL/S • STOP 	- Clears input digit before entry in VFO mode. (p. 7) - Returns to VFO mode when selecting MEMORY mode or the call channel. (p. 10) - Cancels programmed scan, memory scan or priority watch. (pgs. 11, 12)	No function.
PRIO 4		Starts priority watch. (p. 12)			
5		No function.			
6		No function.			
7		No function.			
8		No function.			
BEEP 9		Turns beep tones ON and OFF. (p. 8)			
0		No function.			
	- Increases the frequency in VFO mode. (p. 7) - Increases the channel number in MEMORY mode. (p. 10)	No function.	MR/MW B	Selects MEMORY mode. (p. 10)	Writes the VFO contents into the memory channel. (p. 10)
			MS/PS C	Starts memory scan. (p. 11)	Starts programmed scan. (p. 11)
			CALL/LOCK D	Recalls the call channel. (p. 10)	Activates and cancels the lock function. (p. 8)



## ■ Function display

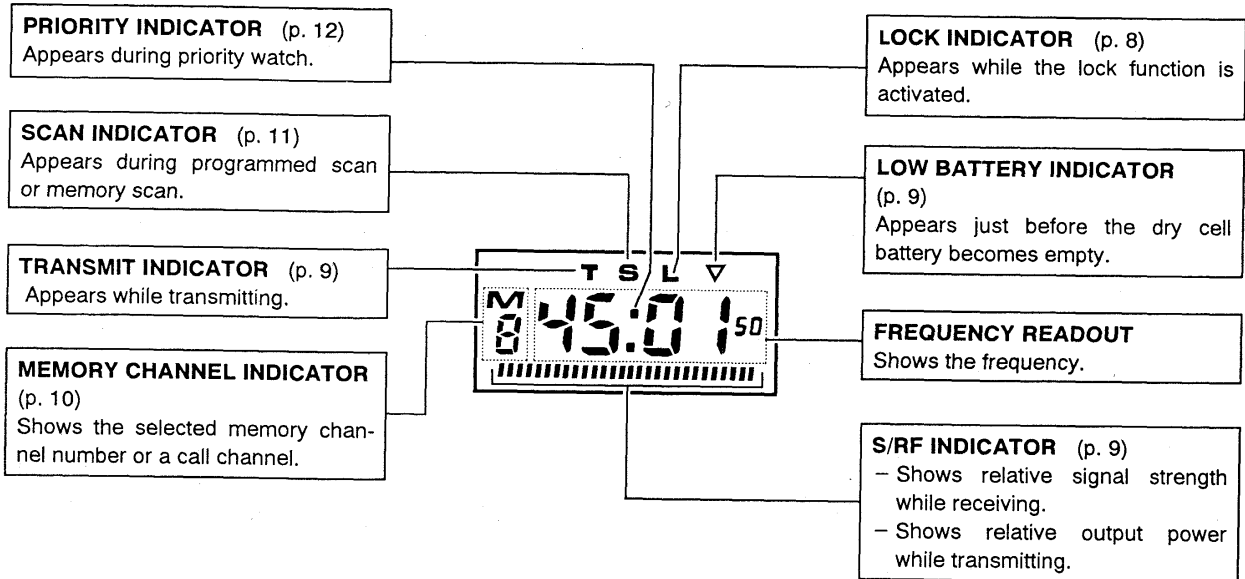

# 3

## FREQUENCY SETTING

### Using digit keys

- ① Rotate the [VOLUME] control clockwise to turn power ON.
- ② Push [Ⓐ CL/S-STOP] to select VFO mode.
- ③ Input 3 digit keys from the MHz digit.

**[Example]** Setting to 145.10 MHz.

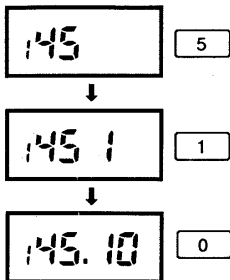

When a digit is mistakenly input, push [Ⓐ CL/S-STOP], then input again.

### Using $\Delta/\nabla$ keys

- ① Rotate the [VOLUME] control clockwise to turn power ON.
- ② Push [Ⓐ CL/S-STOP] to select VFO mode.
- ③ Push [Ⓢ  $\Delta$ ] or [Ⓢ  $\nabla$ ] to change operating frequency.
  - Operating frequency changes according to selected tuning step.

**[Example]** If tuning step is 5 kHz.

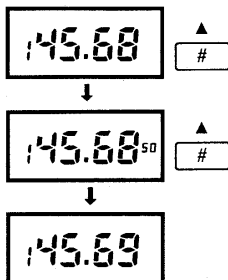

### Tuning step

For frequency setting using [Ⓢ  $\Delta$ ] or [Ⓢ  $\nabla$ ], select a tuning step according to your area.

- ① Push [Ⓐ CL/S-STOP] to select VFO mode.
- ② While pushing [FUNC], push [③ STEP]. Continue to push [FUNC].
- ③ Select desired tuning step number according to the following chart.

Tuning step	Tuning step number
5 kHz	1
10 kHz	2
15 kHz	3
20 kHz	4
25 kHz	5

- ④ Release [FUNC].
  - Operating frequency appears.

## Lock function

The lock function prevents accidental frequency changes and unnecessary function access.

- While pushing [FUNC], push [ⓐ CALL/LOCK] to activate this function.

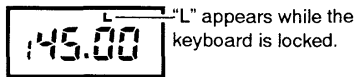

- To cancel the function, while pushing [FUNC], push [ⓐ CALL/LOCK] again.

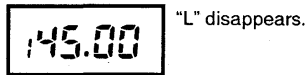

## Display lighting

The transceiver has display lighting for night operation.

[LIGHT] switch position



OUT position:  
Display lighting  
OFF



IN position:  
Display lighting  
ON

Keep in the OFF position after reading display to conserve battery power.

## Beep tone

The transceiver emits a beep tone for key entry confirmation.

While pushing [FUNC], push [ⓑ BEEP] to turn beep tones ON or OFF.

## ◇ VFO and MEMORY modes

This transceiver has 2 operating modes: VFO mode and MEMORY mode.

### VFO mode

Used for setting desired frequency.

"M" does not appear.

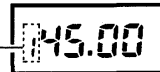

### MEMORY mode

Used for memory channel operation. 10 memory channels are available to store 10 independent frequencies.

"M" appears.

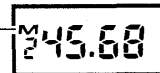

### What is VFO?

VFO is an abbreviation of Variable Frequency Oscillator. Required frequencies are controlled by the VFO.

## Receiving

- ① Rotate the [SQUELCH] control to maximum counterclockwise.
- ② Rotate the [VOLUME] control to the desired audio output level.
- ③ Rotate the [SQUELCH] control clockwise until the noise is muted.
- ④ Set the operating frequency.
  - When a signal is received, squelch opens and audio is emitted.

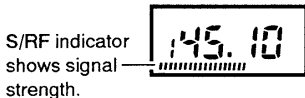

When the [SQUELCH] control is set extremely clockwise, squelch may not open for weak signals.

## Transmitting

**CAUTION:** Transmitting without an antenna may damage the transceiver.

Before transmitting, listen on the frequency first to prevent interference to other stations.

- ① Set the operating frequency.
- ② Push and hold the PTT switch to transmit.

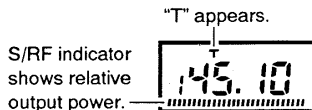

- ③ Speak into the microphone at your normal voice level.
- ④ Release to receive.

**DO NOT** hold the transceiver too close to your mouth or speak too loudly. This may distort the signal.

## Output power

Push the [HIGH/LOW] switch to select output power.

[HIGH/LOW] switch position



OUT position: High power

- 3.5 W with the BP-4
- 5 W with the BP-7, BP-70 or 13.8 V DC



IN position: Low power

- 500 mW

### ◇ Low battery condition

While transmitting, "▽" appears just before the battery becomes empty. In this case, replace dry cell batteries with new ones.

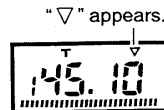

## Special functions

Memory channels 3, 4, 5 and 6 have special functions as below:



M3	Call channel (p. 10)
M4	Priority channel (p. 12)
M5	Scan edge channels (p. 11)
M6	

## Call channel

A call channel stores a most often-used frequency for quick recall.

- ① Program your most often-used frequency into memory channel 3.
- ② Push [D CALL/LOCK] to select the call channel.
  - "C" appears.
- ③ Push [A CL/S•STOP] to return to previous mode.

## Programming

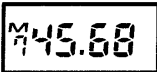
- ① Push [A CL/S•STOP] to select VFO mode.
  - ② Select the desired frequency to be programmed.
- 
- ③ While pushing [FUNC], push [B MR/MW]. Continue to push [FUNC].
- 
- ④ Push a digit key for a memory channel.
    - [0] - [9] are available.
- 
- ⑤ Release [FUNC].

## Memory recall

- ① Push [B MR/MW].

"M" appears.



- ② Push a digit key for a memory channel.

Memory channel number appears.

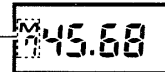

- ③ To select a different memory channel, push a digit key, [F # Δ] or [F \* ▽].
- ④ Push [A CL/S•STOP] to return to VFO mode.

"M" disappears.

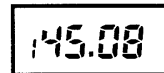

# 6 SCAN OPERATION

## ■ Scan types

2 scan types are available.

### ◇ Programmed scan

Repeatedly scans all frequencies between 2 specified frequencies in memory channels 5 and 6. This is convenient when searching for signals in a specified range.

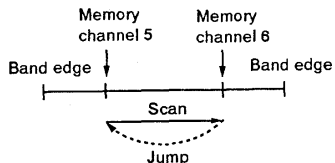

### ◇ Memory scan

Repeatedly scans memory channels 0 - 9 sequentially. This is convenient when searching only for desired frequencies.

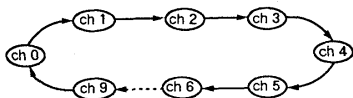

## ■ Programmed scan

- ① Program scan edge frequencies into memory channels 5 and 6 in advance.
  - Refer to p. 10 "Programming."
- ② Push [A CL/S•STOP] to select VFO mode.
- ③ While pushing [FUNC], push [C MS/PS] to start programmed scan.

"S" appears.

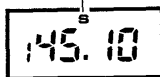

- ④ To cancel programmed scan, push [A CL/S•STOP].

## ■ Memory scan

- ① Program each memory channel in advance.
  - Refer to p. 10 "Programming."
- ② If "C" appears, push [A CL/S•STOP] to select VFO mode.
  - Memory scan cannot be started from the call channel.
- ③ Push [C MS/PS] to start memory scan.

"S" appears.

MEMORY mode is automatically selected.

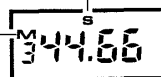

- ④ To cancel memory scan, push [A CL/S•STOP].

### ◇ When a signal is received:

- Scan pauses on the frequency.
- While pausing, scan resumes 2 sec. after the signal disappears.

- To resume the scan manually, push [C MS/PS].

## ■ Priority watch

The priority watch checks for signals on memory channel 4 every 5 sec. while operating on a VFO or another memory channel frequency.

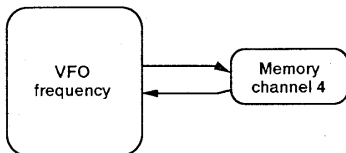

VFO and memory channel 4

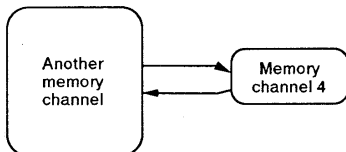

Another memory channel and memory channel 4

While the priority watch operates, you can transmit on an operating frequency (VFO or another memory channel).

### ◇ VFO and memory channel 4

- ① Program the priority frequency into memory channel 4 in advance.
  - Refer to p. 10 "Programming."
- ② Select a VFO frequency.
- ③ While pushing [FUNC], push [④ PRIO].

Priority indicator appears.

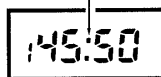

- ④ Push [Ⓐ CL/S•STOP] to cancel priority watch.

### ◇ Another memory channel and memory channel 4

- ① Program the priority frequency into memory channel 4 in advance.
  - Refer to p. 10 "Programming."
- ② Select another memory channel.
  - Refer to p. 10 "Memory recall."
- ③ While pushing [FUNC], push [④ PRIO].

Priority indicator appears.

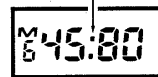

- ④ Push [Ⓐ CL/S•STOP] to cancel priority watch.

Problem	Possible cause	Solution	Ref.
<ul style="list-style-type: none"> <li>No power comes on.</li> </ul>	<ul style="list-style-type: none"> <li>The batteries are exhausted.</li> <li>Poor plug connection to the DC power cable.</li> </ul>	<ul style="list-style-type: none"> <li>Place new dry cell batteries in the battery case or charge an optional battery pack.</li> <li>Check the connector.</li> </ul>	pgs. 1, 15
<ul style="list-style-type: none"> <li>No sound comes from the speaker.</li> </ul>	<ul style="list-style-type: none"> <li>The [SQUELCH] control is turned too far clockwise.</li> <li>An earphone or optional speaker-microphone is connected.</li> </ul>	<ul style="list-style-type: none"> <li>Rotate the [SQUELCH] control counter-clockwise.</li> <li>Unplug the earphone or speaker-microphone.</li> </ul>	p. 9
<ul style="list-style-type: none"> <li>Transmitting is impossible.</li> </ul>	<ul style="list-style-type: none"> <li>The batteries are exhausted.</li> </ul>	<ul style="list-style-type: none"> <li>Place new dry cell batteries in the battery case or charge an optional battery pack.</li> </ul>	pgs. 1, 15
<ul style="list-style-type: none"> <li>Frequency cannot be set.</li> </ul>	<ul style="list-style-type: none"> <li>The lock function is activated.</li> <li>MEMORY mode or call channel is selected.</li> </ul>	<ul style="list-style-type: none"> <li>While pushing [FUNC], push [Ⓢ CALL/LOCK] to cancel the lock function.</li> <li>Push [Ⓢ CL/S-STOP] to select VFO mode.</li> </ul>	p. 8 p. 7
<ul style="list-style-type: none"> <li>Scan cannot be started.</li> </ul>	<ul style="list-style-type: none"> <li>The call channel is selected.</li> <li>Priority watch is activated.</li> <li>The squelch is open.</li> </ul>	<ul style="list-style-type: none"> <li>Push [Ⓢ CL/S-STOP] to exit the call channel.</li> <li>Push [Ⓢ CL/S-STOP] to cancel priority watch.</li> <li>Rotate the [SQUELCH] control clockwise.</li> </ul>	p. 10 p. 12 p. 9

### ◇ Backup battery

This transceiver has a lithium backup battery for retaining memory channel and VFO information. Even when the battery is exhausted, the transceiver transmits and receives normally. The usual life of the battery is more than 5 years. Ask your Icom Dealer or Service Center for backup battery replacement. **NEVER** replace it yourself.

### ◇ CPU resetting

**CAUTION:** Resetting the CPU will clear and initialize all memory channels.

If the internal CPU malfunctions, while pushing [FUNC], turn the power ON to reset.



## ■ General

- Frequency coverage : 144.000 – 145.995 MHz
- Mode : FM
- Frequency stability :  $\pm 15$  ppm ( $-10^{\circ}\text{C}$  to  $+60^{\circ}\text{C}$ )
- Antenna impedance :  $50\ \Omega$  (nominal)
- Usable battery pack or case : BP-2 to BP-8 and BP-70
- External DC power supply : 12 – 16 V DC (negative ground)
- Current drain : Transmit
 

High	1.05 A
Low	450 mA
Receive	
Squelched	35 mA
Max. audio output	140 mA
- Tuning steps : 5, 10, 15, 20 and 25 kHz
- Usable temperature range :  $-10^{\circ}\text{C}$  to  $+60^{\circ}\text{C}$
- Dimensions (with BP-4) : 65(W)  $\times$  167(H)  $\times$  35(D) mm (projections not included)
- Weight : 535 g (with BP-4 and batteries)

## ■ Transmitter

- Output power : High
 

3.5 W (with BP-4)
5.0 W (with BP-7, BP-70 or 13.8 V DC)

 Low  
 500 mW

- Modulation system : Variable reactance frequency modulation
- Max. frequency deviation :  $\pm 5$  kHz
- Spurious emissions : Less than  $-60$  dB
- Microphone impedance : 2 k $\Omega$

## ■ Receiver

- Receive system : Double-conversion superheterodyne
- Intermediate frequencies : 1st 16.9 MHz  
2nd 455 kHz
- Sensitivity : Less than  $0.25\ \mu\text{V}$  for 12 dB SINAD
- Squelch sensitivity : Less than  $0.1\ \mu\text{V}$  (threshold)
- Selectivity : More than 15 kHz/ $-6$  dB  
Less than 30 kHz/ $-60$  dB
- Spurious response rejection : Less than  $-60$  dB
- Audio output power : 500 mW at 10% distortion with an 8  $\Omega$  load
- Audio output impedance : 8  $\Omega$

**All stated specifications are subject to change without notice or obligation.**

## ◇ Chargers

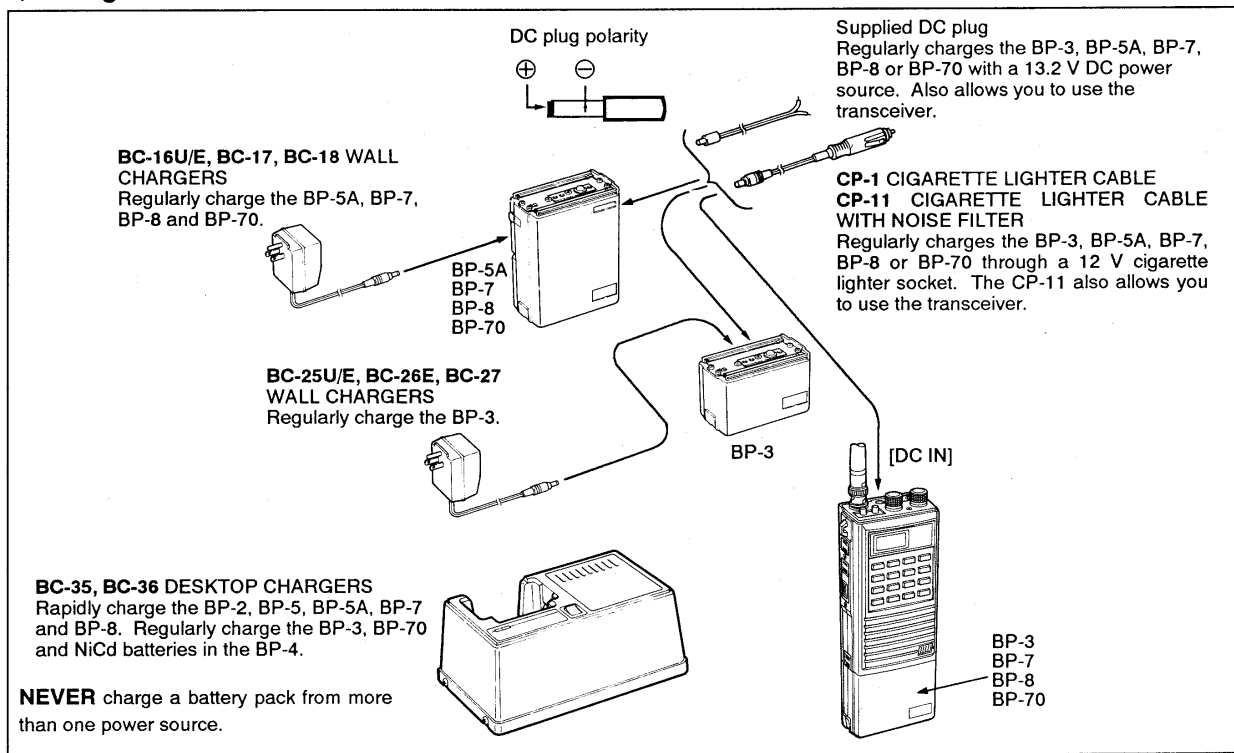

◇ Battery packs, chargers and carrying cases

Model	Output voltage	Capacity	BC-35 BC-36	BC-25U/E BC-26E BC-27	BC-16U/E BC-17 BC-18	CP-1 CP-11	External DC power	Height	Carrying case
BP-2	7.2 V	450 mAh	1.5 hrs.	N/A	N/A	N/A	N/A	39 mm	LC-11
BP-3	8.4 V	270 mAh	15 hrs.	15 hrs.	N/A	15 hrs.	15 hrs.	39 mm	LC-11
BP-4	AA (R6) size batteries × 6		15 hrs.	N/A	N/A	N/A	N/A	49 mm	LC-11
BP-5	10.8 V	450 mAh	1.5 hrs.	N/A	N/A	N/A	N/A	56 mm	—
BP-5A	10.8 V	450 mAh	1.5 hrs.	N/A	15 hrs.	15 hrs.	15 hrs.	80 mm	LC-14
BP-7	13.2 V	450 mAh	1.5 hrs.	N/A	15 hrs.	15 hrs.	15 hrs.	80 mm	LC-14
BP-8	8.4 V	800 mAh	3 hrs.	N/A	15 hrs.	15 hrs.	15 hrs.	80 mm	LC-14
BP-70	13.2 V	270 mAh	9 hrs.	N/A	9 hrs.	9 hrs.	9 hrs.	60.5 mm	—

Times: charging periods

N/A : Not applicable

— : No carrying case is available for the BP-5 and BP-70.

For the BP-4, charge only when NiCd batteries are installed. **NEVER** charge other batteries. This may cause an explosion.

◇ Other options

**HM-9 SPEAKER-MICROPHONE**  
Rounded design neatly fits your hand.

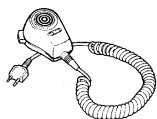

**MB-16 MOBILE MOUNTING BRACKET**

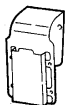

**HM-46 SPEAKER-MICROPHONE**  
Compact and lightweight.

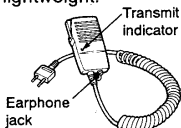

**MB-16D WALL BRACKET**



**HM-54 SPEAKER-MICROPHONE**  
Durable and full-sized.

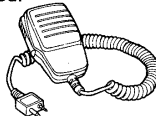

**ST-10 SHOULDER STRAP**

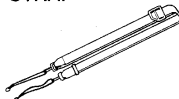

**HS-51 HEADSET**  
Allows you hands-free operation. Includes the VOX, PTT switch and "one-touch" PTT (TOT).

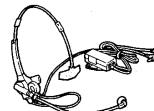

**BA-10 BOTTOM CAP**  
Protects terminals on the base of the transceiver when using external DC power.



**CP-10 BATTERY SEPARATION CABLE**  
For separating the transceiver from the battery pack.

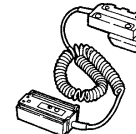

**Count on us!**

A-5246S-1EX-①  
Printed in Japan  
Copyright © 1993 by Icom Inc.

**Icom Inc.**  
6-9-16, Kamihigashi, Hirano-ku, Osaka 547, Japan