

**THE
ELECTRONIC EXPERIMENTER'S
MANUAL**

by DAVID A. FINDLAY

**ZIFF-DAVIS PUBLISHING COMPANY
NEW YORK**

Copyright, 1959, by the Ziff-Davis Publishing Company. All rights reserved. This book, or parts thereof, may not be reproduced in any form, except for the inclusion of brief quotations in a review, without permission of the publishers.

Library of Congress Catalog Card Number 59-15254

Manufactured in the United States of America

CONTENTS

INTRODUCTION

1. GETTING STARTED 1
 - Tools 2
 - Solder and Flux 4
 - Soldering Technique 5
 - Screwdrivers 8
 - Pliers 10
 - Wire 12
 - Working with Wires 13
 - Wiring Techniques 14
 - Shielded Wiring 16
 - Hardware 17

2. THE PARTS YOU NEED 19
 - Tubes and Transistors 19
 - Resistors and Capacitors 25
 - Potentiometers 27
 - Capacitors 28
 - Transformers 33
 - Where to Get Parts 36

3. PLANNING AND MAKING A CHASSIS 37
 - Laying Out the Chassis 39
 - Making a Chassis from Scratch 43
 - Dressing Up a Chassis 48

4. WIRING THE CIRCUIT 49
 - Trouble Shooting 51

5. MAKING PRINTED CIRCUITS 53
 - Laying Out the Circuit 53
 - Cutting Corners 61
 - Stripping 62

6. BUILDING A WORKSHOP 65
 - Apartment Workshop 65
 - Full-size Workshop 68
 - Workbench Tricks 71

7. SPECIAL TOOLS YOU CAN BUILD	80
Chassis Holders	80
Plastic Cutter	90
Coil Winder	93
Permanent Breadboard	98
Jig for Soldering-gun Tips	100
8. MAKING YOUR OWN TEST EQUIPMENT	104
Which Instrument First?	104
Make Your Own Multi-tester	104
Vacuum-tube Voltmeter	108
Check Your a.c. Calibration	112
Economy Transistor Checker	115
Power Supply for Transistor Experiments	118
Audio Oscillator	122
R.F. Signal Generator	128
Power Transistor Signal Tracer	133
9. PROJECTS YOU CAN BUILD	136
Low-cost Broadcast Receiver	136
One-tube Hi-Fi AM Tuner	138
V.H.F. Explorer's Receiver	141
Printed-circuit Transistor Receiver	145
Listen to Aircraft with a Miniature v.h.f. Receiver	150
Two-tube Economy Amplifier	153
Transistorized Intercom	158
Transistorized Photoflash	163

INTRODUCTION

ELECTRONICS is unique among the sciences in that the beginner with simple hand tools and nothing more than a table top for a laboratory can construct and operate electronic equipment that is as modern as guided missiles. The builder does not have to understand the complex physical and electrical principles behind the device he builds. He can have the pleasure of putting the unit together and seeing it operate with little or no understanding of electronics.

There are many magazines that provide circuit and construction details for many projects. However, these monthly publications cannot carry in each issue the basic construction techniques that the beginner must learn.

This is the gap that this book is intended to fill. Using this book as a guide, the beginner can start out with confidence on his construction project.

Much of the material used in the preparation of this book came from pages of *Popular Electronics*. In the past five years, this magazine has published a great many articles dealing with various phases of electronic construction. The author has used many of these articles as a basis on which to build this book. For this reason, I would like to acknowledge the help of the editors of *Popular Electronics*.

Particular thanks are due to Lou Garner, whose excellent articles on printed circuits and electronic components formed the foundation for a number of chapters in the book, and to Oliver Read and James Fahnstock for their comments and criticisms.

The author would also like to extend his appreciation to Barbara Hearst for her typing of the manuscript and copy editing. And, to his wife for her patience and understanding as well as for her helpful suggestions and comments.

DAVID A. FINDLAY

1 GETTING STARTED



Fig. 1—As a hobby, electronic experimenting offers the thrill of accomplishment and knowledge of the most fascinating science of our day.

ELECTRONIC experimenting, one of the fastest growing hobbies in the world, is also one of the most exciting. A few tubes or transistors, some resistors and capacitors, and you can be in touch with radio stations all over the world or with an earth satellite speeding through space. The hobby requires little in the way of money, or even knowledge at the start, but will pay off right away in successful projects and will furnish you with a store of electronic know-how for those more exciting projects to come.

In addition to the fun, there are practical benefits from electronic experimenting. Around your home you will find many opportunities to apply your electronic know-how. Garage-door openers, intercoms, and remote-control devices are only a few of the projects you may undertake to improve your home.

Experimenting can also be a stepping-stone to a real career in electronics. Many electronic technicians received their basic training at their home workbenches. The construction projects detailed in the later chapters of this book will help to give you an understanding of many of the basic principles of electronics.

With about 5 dollars invested in tools (you probably have most of them around the house now) and a bit more invested in parts you can start in electronics. What will your first project be? A short-wave receiver for listening to London, Paris, or Moscow? A transistor radio half the size of a pack of cigarettes? That's up to you. Pick the one you want, and you're on your way.

You don't have to know all about electronics to get started on your project. Any project in this book or in the popular electronics magazines can be built simply by following instructions. This method is all right for the beginning, but as you become more familiar with circuits and parts you will want to know more about what makes them work.

Building any electronic project is a matter of following a series of simple steps. To help you to understand these steps, the first chapters of this book have been arranged in such a step-wise order.

The first step is to read over the instructions and study the circuit diagram or pictorial layout. Looking at the photographs of the finished equipment will give you a good idea of where the parts should be placed on the chassis. The next step is to gather together the parts needed; to become familiar with their shape and size and how they are mounted on the chassis. The third step is to lay out the parts on this chassis, drilling holes where required. The fourth step is to mount the parts and do the wiring job. The final step is a check of your wiring for errors, making necessary adjustments. Then you're ready to put your project into operation.

Each of these stages will be covered in detail in future chapters, but before we proceed, there are some basic things you should know about building electronic equipment—how to use your tools, how to solder, how to work with wire, and what kind of wire to use.

Tools

The basic tool kit of an electronic experimenter consists of a soldering iron or gun, a set of screwdrivers, and two pairs of pliers. These are the tools of wiring. Other tools, such as drills and saws, will be required to build chassis and cabinets for equipment. These additional tools will be discussed in the chapter on chassis construction.

Of all your tools, you will probably use your soldering iron or gun more than any other, for this is the basic tool of electronic construction.

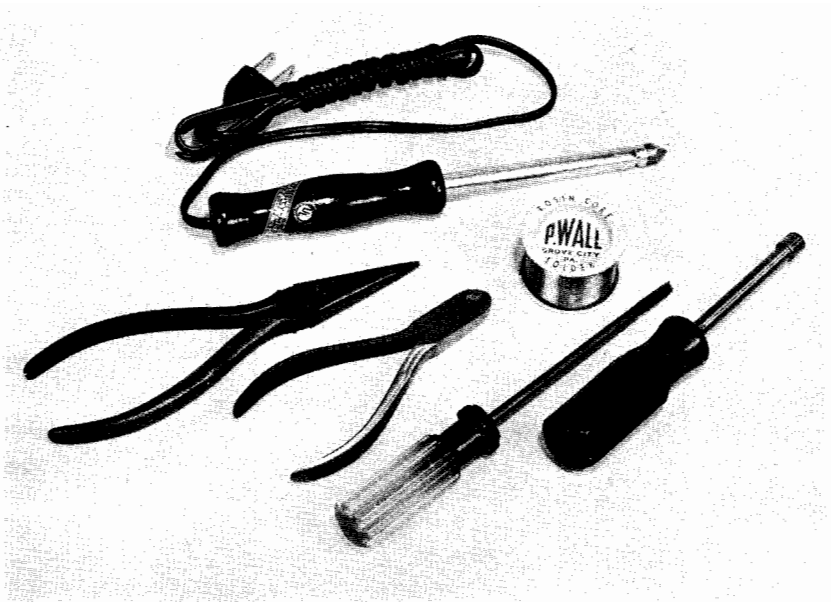

Fig. 2—The basic tools of the electronic experimenter.

To ensure that they will conduct electricity properly, every joint in an electronic circuit must be soldered. Although soldering is a simple procedure, it must be done correctly each time. One improperly soldered joint in a circuit is enough to make the entire circuit inoperative. Tracking down the results of poor workmanship in a complicated circuit can take hours of your time and rob you of the fun of seeing your project “come to life” when you turn it on for the first time.

Because your soldering tool is so important in your work, you should choose it carefully and learn how to use it properly. There are two types of soldering tools—the soldering iron and the soldering gun. Both types are shown in Fig. 3. Most of us are familiar with a soldering iron, but the soldering gun is a more recent development that has rapidly become a favorite with technicians, repairmen, and experimenters.

Care should be taken in selecting a soldering iron. Too large an iron can be hard to handle and may deliver too much heat to the joint, resulting in burned insulation and damaged components. If the iron is too small, it may deliver too little heat to melt the solder sufficiently to make a good electrical connection. A good basic iron for the electronic experimenter should be rated at 100 to 150 watts. This will give enough heat to handle most jobs.



Fig. 3—General-purpose soldering gun at top has built-in spotlight. Small soldering iron at center is useful for printed circuit work and miniaturized projects. Large iron at bottom is suitable for most types of electronic work.

If you intend to do a lot of work with miniature equipment, transistor circuits, and similar small items, a 25- to 60-watt soldering “pencil” is preferable. This iron will provide enough heat to solder small joints and has a small enough tip to let you see what you are doing.

Most soldering irons and pencils come with two or three interchangeable tips. If the iron you buy does not come with a set of tips, pick up a couple of extra ones. A long, thin tip will come in handy in many tight spots, and a large one is useful for heating large areas.

A soldering gun, though more expensive than an iron, has many attractive features. An on-off switch permits you to turn the gun on only when you need it. The tip heats almost instantly when the trigger is pressed and cools down quickly when the switch is released. There is less danger of burning things (including yourself) with a soldering gun. Furthermore, most guns have two focused spotlights built into the body that illuminate the work area when the gun is in use. A 100-watt gun is small, lightweight, and easy to handle. Its heat is sufficient for almost all jobs, from making small connections to soldering a fairly heavy ground to the chassis. If you are going to do a lot of heavy-duty work, a 250-watt gun might be preferable.

The narrow tip of a soldering gun is especially useful for getting into the deep, dark corners of a chassis or working in the tight places of miniature circuits and printed-circuit boards. The tips can also be bent to reach around corners.

Solder and Flux

Solder and flux are used with a soldering iron to join two materials. The flux helps the solder “wet” the surface of the materials, by removing oxidized surface film, so that the solder can penetrate the pores of the material. The flux itself does not react with the metals being soldered,

but it is necessary in order to solder a joint properly. In electronic work, a rosin flux is *always* used. Acid flux solder is also available, but it should *never* be used in electronic equipment. Although a piece of equipment assembled by the use of acid flux may work properly at first, the acid will gradually corrode the joint and build up an oxide that will prevent electrical flow through the connections.

For electronic work, a 50-50 or 60-40 wire solder is preferred. The first figure refers to the percentage of tin; the second refers to the percentage of lead in the alloy. In general, the higher the percentage of tin, the lower the melting point of the alloy.

Most experimenters and servicemen prefer to use cored solder. This is a hollow tube of solder with flux in the core. When the solder is heated, the flux melts first and flows out over the joint. The solder then melts and makes the connection.

Soldering Technique

Soldering with either iron or gun follows exactly the same procedure. The joint is heated; solder and flux are applied and allowed to flow over the joint; the heat is removed; and the joint is allowed to cool. That's all there is to it. However, there are several important points that must be observed to ensure a good soldering technique.

First of all, the joint must be clean. All grease, dirt, corrosion, or enamel must be removed from the surface of the metal before the joint is soldered. Use steel wool, sandpaper, a file, knife, or wire brush to do this job. Clean the surface until bright metal shows through at the point to be soldered.

Next, heat the joint to a temperature high enough to melt the solder. This is the secret of good soldering! Never touch the solder to the iron to melt it. Heat the joint and touch the solder to the point you want to solder. The solder will melt and flow over the wires. Don't keep the iron on the joint too long. As soon as the solder flows, remove the soldering iron and let the joint cool. Don't be tempted to wiggle the joint to test it. If you do, you may ruin an otherwise perfect connection. Let your testing wait until the joint has completely cooled.

A final trick in good soldering is to keep the soldering-iron tip clean and well tinned. If the tip of the iron is not clean, a film of oxidation will form and prevent heat from reaching the joint. Tinning is simply keeping the tip covered with a coating of solder (see Fig. 5). This is done to ensure the quickest possible transfer of heat from the tip to the work. To tin an iron simply heat it and apply solder to the tip.

A cold solder joint will result from insufficient heat. You will recognize the cold solder joint from its rough, grainy appearance compared

to the smooth, shiny surface of the well-soldered joint (see Fig. 6). To repair a cold solder joint apply the hot soldering iron until the solder begins to flow. That's all there is to it.

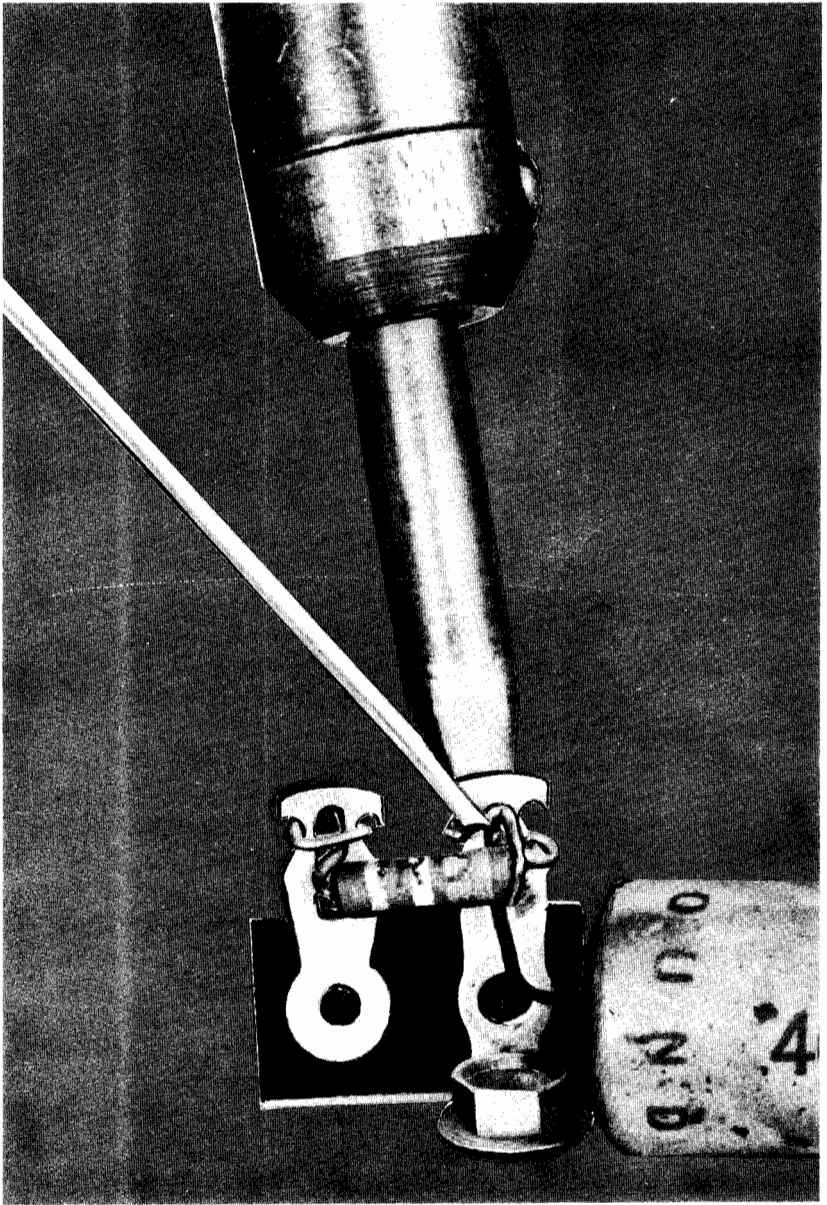

Fig. 4—Correct soldering technique.

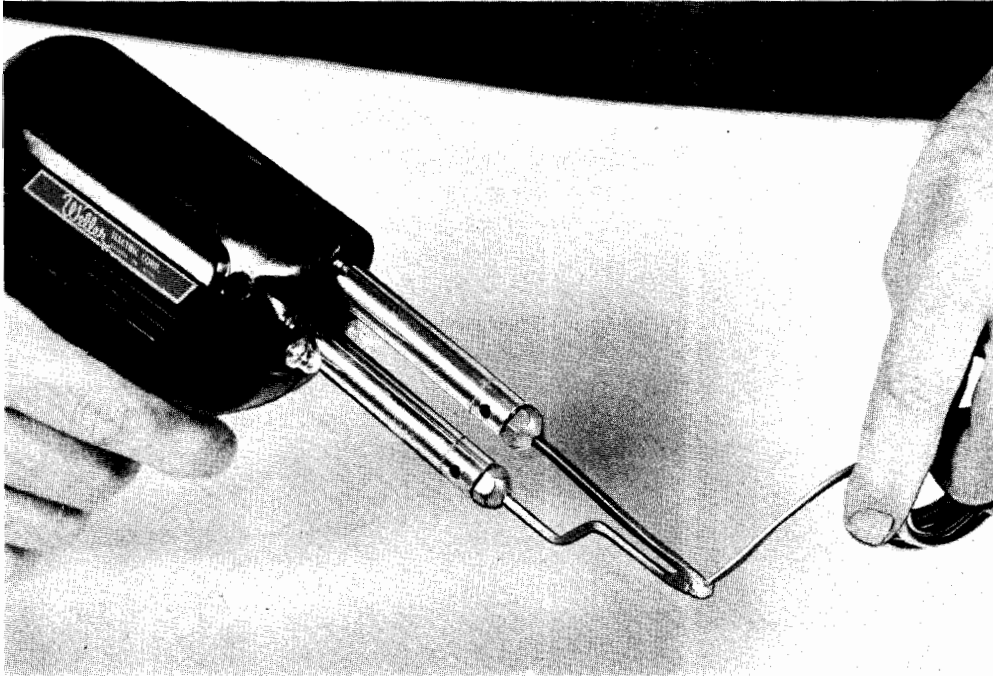

Fig. 5—Tinning the tip of a soldering gun.

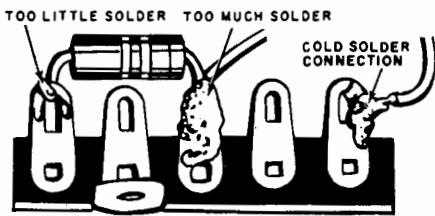
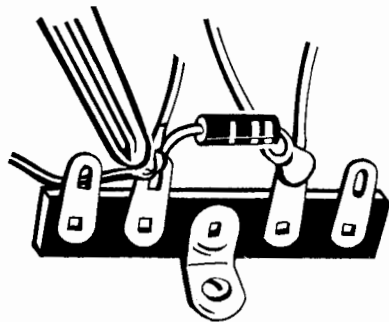

Fig. 6—Cold solder joint.



Screwdrivers

Next to your soldering iron, your screwdrivers are the tools you will reach for most often on a project. At first, one with a 4-inch shaft and a $\frac{3}{16}$ -inch tip will serve nearly all your requirements. Later, you will want other sizes, including screwdrivers with longer shafts to reach out-of-the-way places and a couple of stubby ones for the tight spots.

There are two main types of screwdrivers—the familiar flat-bladed kind and those with an “X”-shaped tip known as “Phillips-head” screwdrivers. While you are assembling your own projects, you will not need the Phillips-head screwdriver. However, when you start to work on commercial electronic equipment or to build kits you will require a few of these. Phillips-head screws are often used on the outside finished panels of equipment because there is less likelihood that a Phillips-head screwdriver will slip out of the slot and scratch the finish.

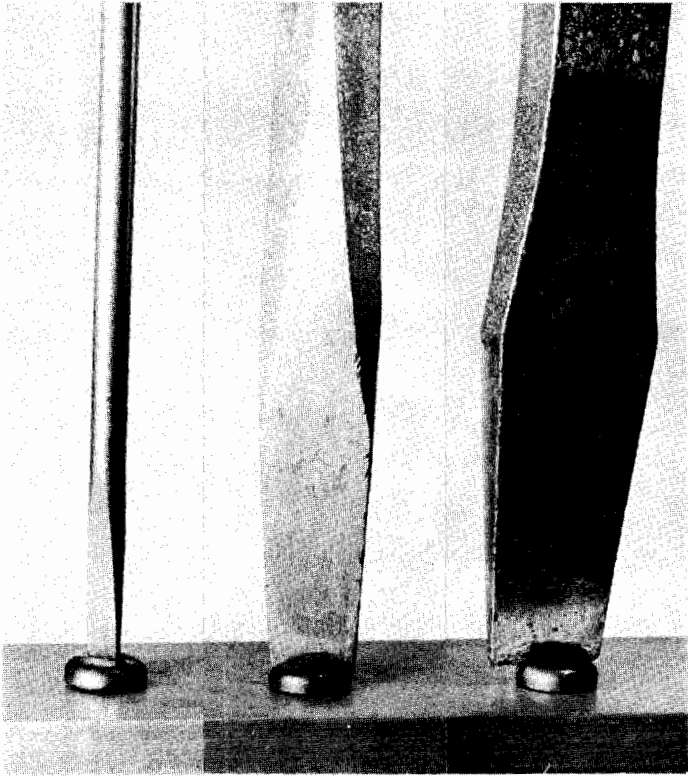

Fig. 7—The screwdriver at the left is too small; its blade could snap. Screwdriver at right is too large and could damage screw. Screwdriver in center fits snugly into slot and has proper width.

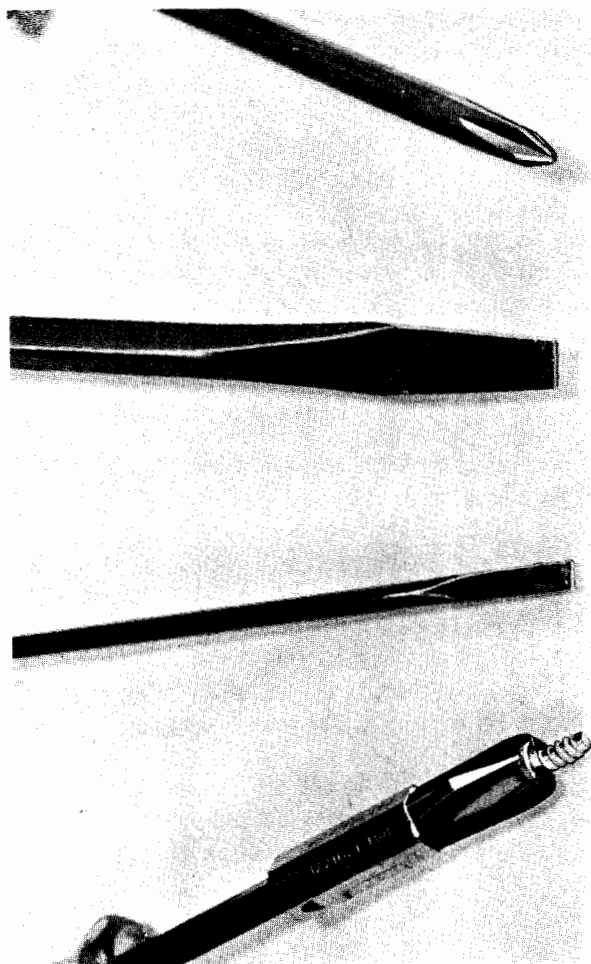

Fig. 8

When you use the correct flat-bladed screwdriver, there is little chance of its slipping either. The right size screwdriver is the one that fits the slot snugly, as shown in Fig. 7. If the blade is too small, it may break. If the blade is too large, you may damage the slot in the screw, in which event it will be almost impossible to turn even when the right screwdriver is used.

The screw-holding type of screwdriver shown in Fig. 8 has a device that holds the head of the screw firmly against the blade of the screwdriver. With this handy tool, you can insert screws in hard-to-reach

places. A magnetized-head screwdriver can also be used for this purpose; it will also be useful to retrieve bolts and nuts. However, it can also become a nuisance by picking up bits of metal and scraps when you are using it for ordinary jobs.

Another useful type is the jeweler's screwdriver. This is a very small-tipped screwdriver with a rotating top. It is held in one hand, pressure is applied to the screw by placing the index finger on top of the screwdriver, and the shaft is rotated between the thumb and middle finger. You will find this tool very useful for work with miniature equipment. The jeweler's screwdriver is also available in sets with a number of interchangeable blades.

Pliers

Pliers can be used to bend and cut wires, to strip insulation, and to hold small parts and nuts. The most useful pliers for the experimenter are the long-nose type, which have a cutting blade at the end of the jaws closest to the joint. These pliers will handle all of the jobs required in electronic construction. They are especially useful to bend wires and squeeze leads in tight places, but the position of the cutting blade makes it impossible to cut wires close to the chassis. Therefore, you should also own a pair of side cutters. The side cutter has a cutting blade that extends out to the tip of the jaws, so that you can make a cut anywhere you can insert the tip.

A pair of gas pliers is also handy for holding nuts and doing heavy bending work. The long-nose pliers should never be used for heavy work. Too much pressure will spring or break the jaws.

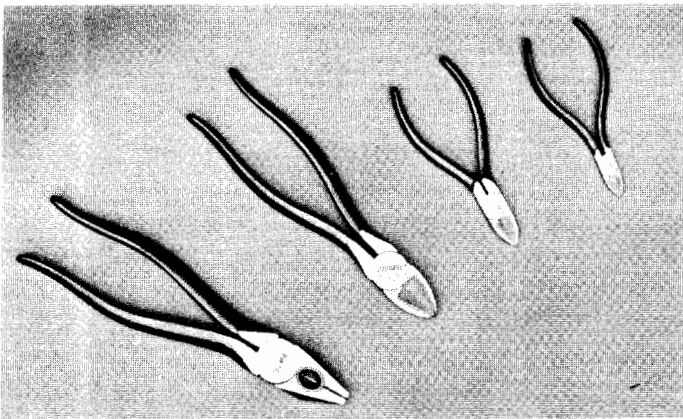

Fig. 9—Side cutting pliers (right) and lineman's pliers (left).

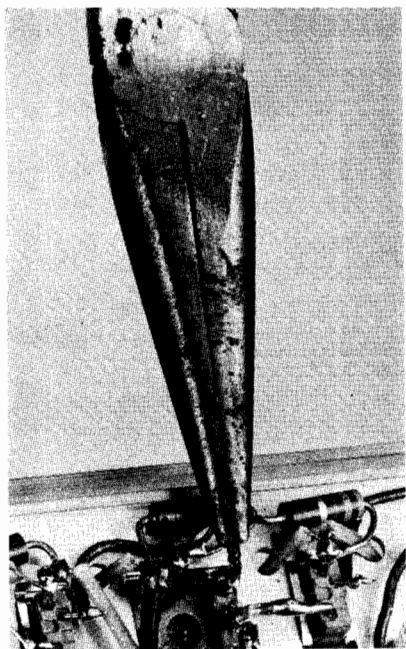

Fig. 10—Long-nose pliers.

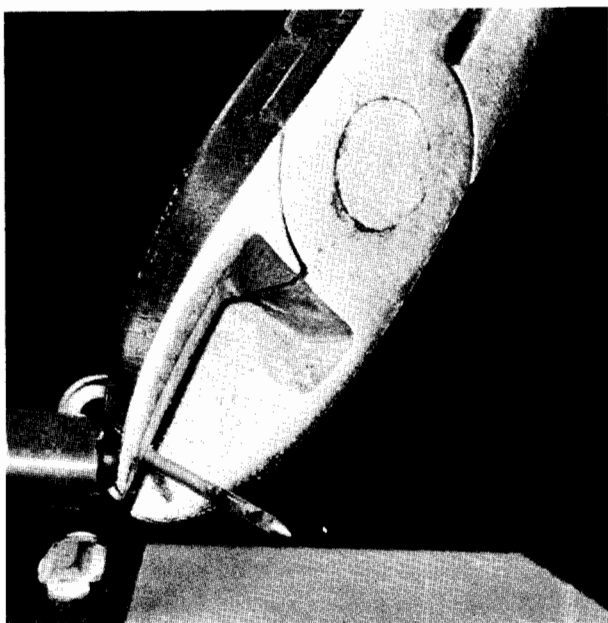

Fig. 11—Side cutting pliers provide close cutting to trim leads and to cut wires to size.

Wire

In addition to tools, every electronic experimenter needs wire to hook up the electronic parts and, also, hardware to mount the parts on a chassis.

Two types of hookup wire are used in electronic work—solid and stranded. These wires are available with various types of insulation, including enamel, cloth, and plastic. Solid wire is available also without insulation, or bare. In addition, wire is available in various sizes ranging from No. 40 (about $\frac{3}{1000}$ inch in diameter) up to a size of No. 0000 (almost $\frac{1}{2}$ inch in diameter). These size numbers are the American Wire Gage (AWG) sizes.

If this sounds like a lot of wire to have in stock, you are right! Actually, for electronic work, you will need only three or four sizes. Practically all of your circuit wiring can be done with a No. 20 or No. 22 solid, plastic-covered wire. This wire is available from your radio parts house in 25- and 100-foot rolls.

Solid wire is useful for making connections between parts in a circuit, such as between tube sockets and terminal strips. Because solid wire is stiff, it will remain in any shape to which it is bent and so will make a neat appearing wiring job. However, if solid wire is subjected to repeated bending, it will snap. When you need flexibility, stranded wire should be used. This type of wire can withstand vibration or frequent change of position with little danger of breaking.

It is slightly more time consuming to make connections with stranded wire than with solid wire. It is necessary to twist all of the strands together before inserting the wire into a terminal hole. If this is

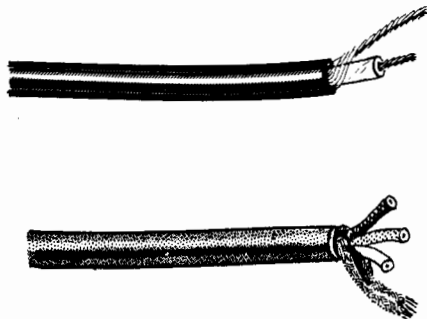

Fig. 12—Two types of shielded cable, single conductor (top) and three-conductor (bottom). Shielded cable is used to protect low-level signals from stray electrical fields.

not done, loose strands may spread out in all directions when the wire is inserted. If the connection points in a circuit are close together, some of the strands may touch another terminal causing a hard-to-find short circuit. When working with stranded wire, coat the twisted strands with solder before hooking up the wire. This will keep the strands from unraveling.

The various types of wire insulation are important to the experimenter. Plastic-covered wire will take care of 90 per cent of your wiring jobs. Such wire has almost entirely replaced cloth-covered wire for general electronic wiring. With cloth-covered wire, it is often difficult to remove all of the strands of cloth when removing the insulation from the end of a wire. With the plastic-covered wire, a quick flick of the knife will remove the insulation neatly.

Because the enamel coating is very thin, an enamel-covered wire is often used in winding coils and in similar applications where it is necessary to get the wires close together.

The only other type of wire required by the electronic experimenter is shielded, or coaxial, wire. This is used in low-level audio and high-frequency circuits. It is simply a conventional plastic-covered wire with a mesh shielding wrapped around. The shielding may be bare or have a rubber or plastic covering. The inner conductor is connected into the circuit (as with conventional wire), and the shielding, or outer conductor, is attached to a ground point at one or both ends. The shielding acts as a guard to prevent stray electric signals from being picked up by the inner conductor.

Working with Wires

Good technique in wiring will give you a finished project that will look neat and will perform properly. Most experimenters prefer to use the point-to-point method of wiring. This technique requires that you cut each wire to a length that will reach the two points to be connected by the shortest possible route. In high-frequency circuits, point-to-point wiring is a necessity because the length of a wire may affect the operation of some critical circuits. In general, it is a good rule to make every wire as short as possible, but not so short that it will put a strain on the terminal. The exception to this rule is in the wiring of filament supplies of tubes. These wires should be twisted together, as shown in Fig. 13, and should be placed as far from the input wiring as possible. Here, it is O.K. to make the wires as long as necessary to keep them away from other wiring in the circuit. If the filament wiring is too close to signal-handling wires, the a.c. current they carry may cause hum in the operating circuits of the equipment.

Fig. 13

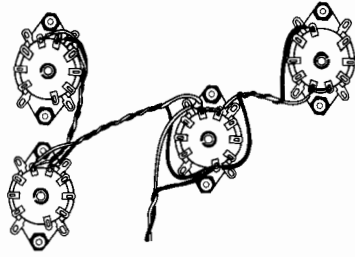

Another exception to the rule of point-to-point wiring is met when a construction project specifies that wires be placed in a certain position. These instructions should be followed precisely. It is not always obvious to the experimenter why these wires should be placed in a certain position. Often, it is not obvious to the original designer of the equipment, either. Frequently, an original piece of equipment is built, and then the designer spends considerable time changing wire lengths and positions of parts to get the circuit to operate at its best.

Wiring Techniques

There are two ways to do a wiring job. Both are good techniques, and you will probably use both, depending on the project on which you are working. For the beginner, the first technique is probably the easiest. First measure the distance between the two points to be connected. Then add $\frac{1}{2}$ inch ($\frac{1}{4}$ inch for the connection at each end) to that length. Cut a piece of wire to this length. Bare $\frac{1}{4}$ inch at each end of the wire using a knife or wire strippers. If you use a knife, be careful not to cut into the wire. A nick may cause the wire to snap after it has been in service for some time. In stranded wire, nicking may cause some of the strands to fall off and leave you with a smaller size wire than the circuit calls for.

To bare plastic-covered wire properly when using a knife, place the wire between your thumb and the blade of the knife. Press your thumb gently on the knife blade and pull the wire with the other hand. The insulation should break at the knife blade leaving the bare conductor.

A convenient tool for removing insulation from the end of a wire is shown in Fig. 14. When used like a pair of pliers, the wire stripper will remove insulation in one step with no danger of nicking the wire. A guide on the side of the blade permits you to set the tool to bare exactly the length of wire you want. A simpler and less-expensive wire stripper consists of a pliers-like unit with one blade notched to accept popular sizes of wire. The cutting blade is set to enter the notch only far enough to cut the insulation.

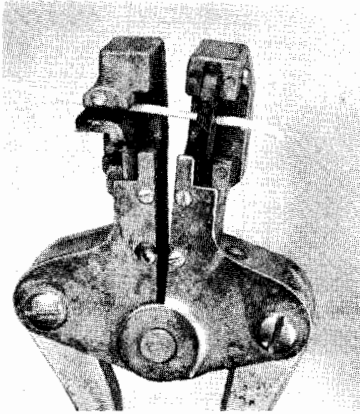

Fig. 14—Wire strippers remove insulating up to the desired point with one squeeze of the handles.

After the end of the wire has been prepared, form a small loop in the wire with the long-nose pliers and place the loop through the hole in the terminal. Then close the loop tightly around the terminal. Do the same at the other terminal and solder both joints if there are no other wires to be connected to these terminals.

An alternative wiring method is to bare the end of the wire on the spool and connect it to one of the terminals. Then lay the wire in place, clipping it from the spool at the point where it reaches the other terminal. Bare this end of the wire and hook it into place. This method usually gives the shortest possible wire length because it is measured right in place. It also eliminates the need for making measurements with a ruler and transferring them to the piece of wire. It has the disadvantage of requiring you to cut and bare the second end of the wire right inside the chassis, where working room and visibility may be limited.

To make connections to terminals, always loop the wire through the hole to give a good mechanical connection. The wire should be in-

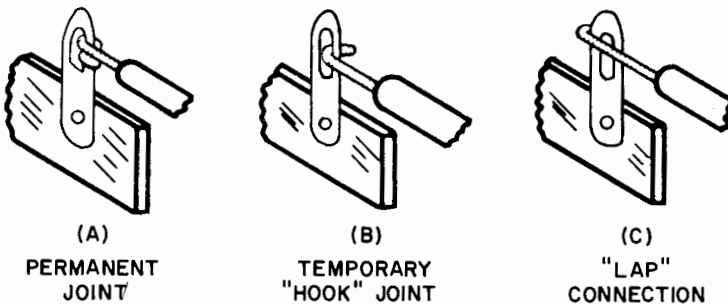

Fig. 15—Three types of mechanical connection used in soldering.

stalled so that it could stay in place without soldering. A good experimenter never depends on solder to hold his wiring together. Because it is relatively weak mechanically, solder should be considered only as a means of making good electrical connections.

Bare wire can often be used in wiring circuits, particularly if there is no danger that the wires will touch. It can almost always be used for short connections, such as those between two adjacent tube socket terminals or between two pins on opposite sides of a socket.

Bare wire can also be used as a ground bus (a wire connecting together all of the ground points to a chassis to ensure good grounding). All wires that are to be connected to ground can be soldered to the bare wire at any point.

Where there is danger of a bare wire touching another wire, "spaghetti" can be used as an insulator. Spaghetti, which looks a great deal like the kitchen variety, is a plastic-coated cloth tube that can be slipped over a wire as insulation. It is particularly useful when you are installing a resistor or capacitor between two widely spaced points or where their leads pass through some tight wiring. To eliminate the chance of a short circuit, cut a piece of spaghetti about $\frac{1}{4}$ inch shorter than the resistor lead and slip it over the wire before soldering.

Spaghetti comes in rolls of a variety of sizes, but one roll of a size to fit No. 20 wire and a roll to fit No. 14 wire will handle almost all wiring jobs.

Shielded Wiring

Working with shielded wire requires careful handling. To make a connection with this type of wire, separate the shielding from the inner insulation far enough back on the wire to be sure that it cannot touch the inner conductor after it is bared. Work carefully so that you do not damage the inner insulation or break strands from shielding. The best method of doing this is shown in Fig. 16. If the shielding is covered by insulation, this can be removed by carefully cutting around the outside with a sharp knife. Next, pull off the insulation using the knife blade and thumb to pull against the rubber. With the insulation off, bend the shielded cable double at a point next to the remaining insulation and spread apart the woven shielding with a pointed tool or the tip of a knife. Now, slip the tip of a small screwdriver under the looped center wire and pull it through the shielding. Flatten out the shielding and twist the strands together to form a wire. Now you can strip the end of the inner wire just as if it were a piece of ordinary hook-up wire.

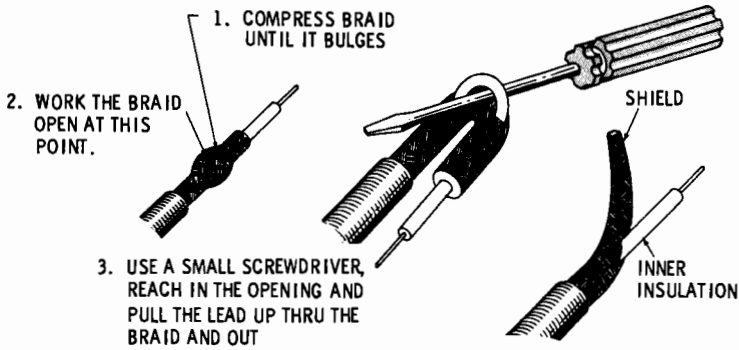

Fig. 16—Technique for stripping shielded cable.

Hardware

Practically all projects will require some bolts and nuts to mount the various tube sockets, switches, and terminal strips to the chassis. (Three types of terminal strips are illustrated in Fig. 18.) Two or three sizes of bolts will handle almost any job. The most common size used for assembly in the 6/32 round-head machine screw. You should have a box of these in $\frac{1}{2}$ - and $\frac{3}{4}$ -inch lengths. It is also good to have some 4/32 screws in $\frac{1}{4}$ -inch length for mounting small tube sockets. For both of these screw sizes you need nuts and lock washers. The latter are always placed under nuts to prevent them from working loose. You should also have a stock of 4/32 and 6/32 solder lugs. These can be used in place of lock washers when you want a good ground connection to the chassis for your wiring.

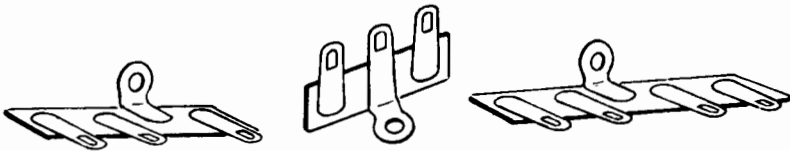

Fig. 17—Terminal strips are available in many different configurations. The center strip has one lug connected to mounting bracket so that it can be used as a chassis ground.

An assortment of flat washers to fit your basic screw assortment is also useful. They will take up space in a hole that is too large for the screw head and they will help the screw to fit loosely in the hole to permit some adjustment of position. Flat washers can also be used as spacers to bring a component to a desired height.

A grommet is another hardware accessory that has many uses. This is a circular piece of rubber that can be fitted into any hole in the chassis through which wires pass. The grommet prevents the sharp

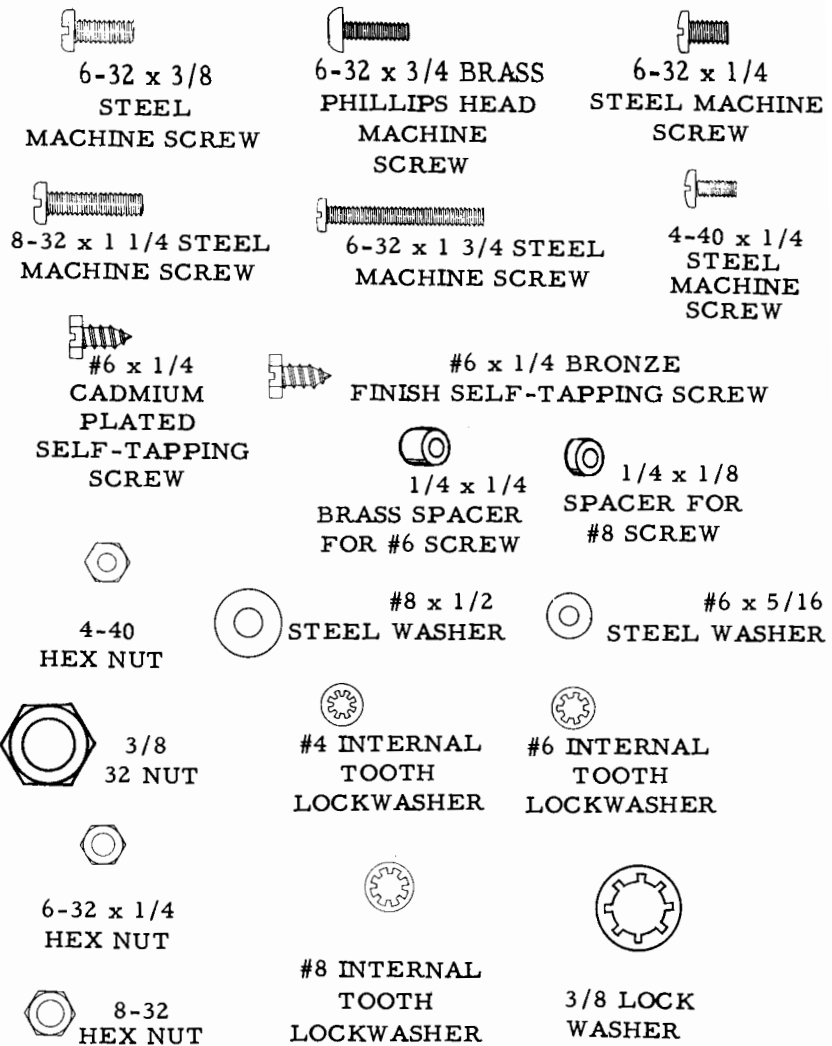

Fig. 18—Common pieces of hardware used to assemble electronic equipment.

edges of the hole from cutting into the insulation of the wire. Grommets should always be used at the point where the power cord passes through the chassis.

Because a 3/8-inch rubber grommet will fit tightly around a pilot light bulb, it can be used as a quick mount for a pilot light. A grommet can also be used to insulate a bolt from the chassis. Drill a hole in the chassis, insert the grommet as an insulator, and insert the bolt with a flat washer on either side of the grommet.

2 THE PARTS YOU NEED

EVERY ELECTRONIC project you will build is made up of a number of parts, or components, hooked together in order to achieve the desired operation of the equipment. These components include tubes, transistors, resistors, capacitors, transformers, chokes, and coils. To do a good job on any electronic project, you should know what these parts look like, how they are used, and the various codes used to identify them.

Each electronic component is given a schematic symbol in a circuit diagram to identify it and show how it is connected into the circuit. In a later section we will analyze a circuit diagram of a simple radio and see how these symbols are used in the construction of the equipment. Here we will look at the parts represented in the circuit diagrams.

Tubes and Transistors

The tube, or the transistor, is the main part of any electronic circuit. This is the device that provides amplification; that boosts a tiny signal from almost nothing to enough power to drive a loudspeaker.

In tube circuits, most of your work will be done with three major tube types—octal, 7-pin miniature, and 9-pin miniature. These names describe the type of base the tube has. The 7-pin and 9-pin tubes and their socket arrangements are shown in Fig. 19. The octal type, the oldest of the three, has 8 pins with a center post. The center post has a key that will permit the tube to be inserted in only one way. The 7- and 9-pin tubes have no center pin. A gap between the first and last pins makes it impossible to insert the tube in the wrong position. The pin numbers are always counted in a clockwise direction, looking at the bottom of the tube or socket. Pin number 1 is always the pin to the left of the key in an octal socket or the space in a 7- or 9-pin socket.

The octal tube has a plastic base that encloses the lower part of the glass envelope. In the 7- and 9-pin types, the tube is all glass with thin pins projecting from the bottom of the glass envelope. Most new tube designs are of the 7- or 9-pin variety. However, the octal tube is still around, and probably will be for a long time to come.

One other type of tube is the subminiature tube. This is a small, flat tube with five wire leads in a row at the base. It is mounted in a special socket (see Fig. 20). These tubes are popular in hearing-aid,

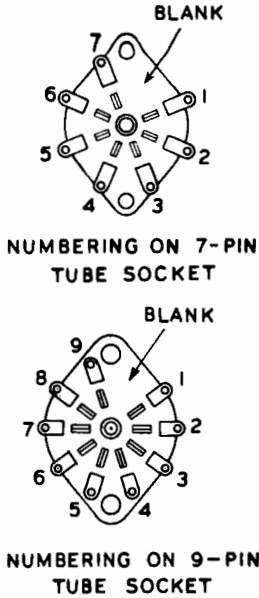

Fig. 19

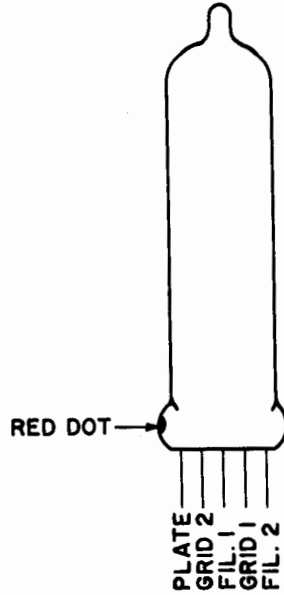

Fig. 20—Subminiature tube.

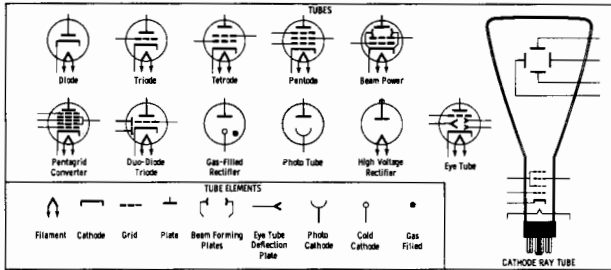

Fig. 21—Symbols for various tube types used by the experimenter.

miniature-radio, and radio-control applications where their small size and low battery-current requirements are valuable.

Every tube is made up of two or more *elements*. These elements include the cathode, plate, and one or more grids (see Fig. 21). Tube-type names are given according to the number of elements in the tube. A tube with two elements (cathode and plate) is called a *diode*. With a grid added, it is a *triode*. A second grid makes it a *tetrode*, and a third grid turns it into a *pentode*. Some special-purpose tubes have as many as five grids.

Although these are the main types of tubes you will encounter, there are many other types that are designed for special purposes such as transmitters, ultra-high frequency circuits, and the like. When you

come across these in a construction article, there will generally be special instructions to guide you in their use.

To save space and simplify circuit construction, many tubes are actually two or more tubes inside the same glass envelope. These *multi-unit* tubes may consist of two diodes, two triodes, a triode and one or two diodes, or any other combination. When both units are of the same type they are called *twins*. A twin diode or twin triode in a circuit will perform the same job as would two separate tubes.

Magic-eye tubes are familiar to most people as the tuning indicator in radios. These tubes are often multi-unit types with a built-in triode amplifier for the signal that controls the magic eye. The symbol for a magic-eye tube is shown in Fig. 22. These tubes are frequently used in experimenter's projects and can be the basis of inexpensive test equipment such as is described in Chapter 8.

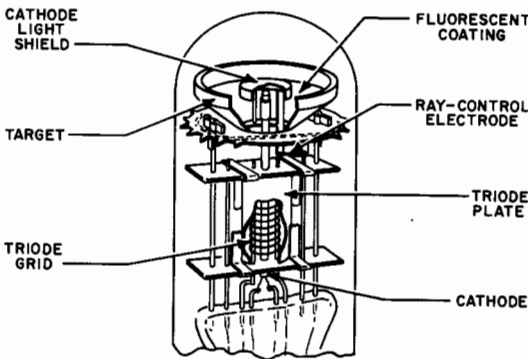

Fig. 22—Cross-section of a magic-eye tube.

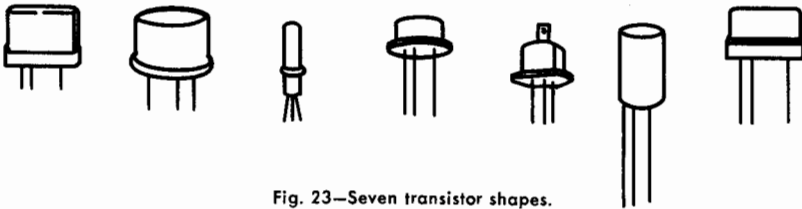

Fig. 23—Seven transistor shapes.

Transistors are made in a variety of shapes, some of which are shown in Fig. 23. The majority of transistors have only three leads as compared to the seven, eight, or nine on a tube. There are four-wire transistors, but these are not too common and are used mainly in high-frequency circuits. Because transistors have an extremely long life, they can be soldered right into a circuit in a manner similar to the soldering of a resistor or capacitor. However, transistors are very sensitive to temperature and can be ruined by too much heat during soldering. To

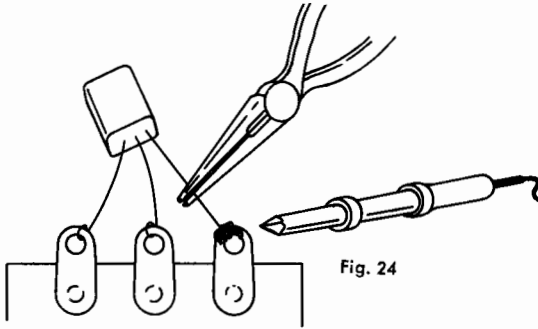

Fig. 24

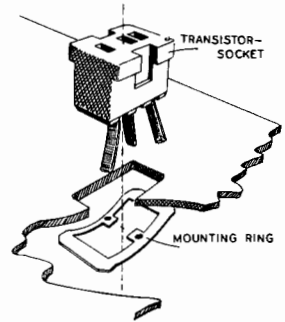

Fig. 25—Transistor socket mounted on a chassis by a metal clip that fits grooves in side of socket.

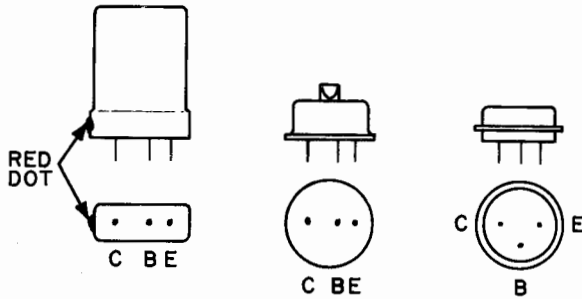

Fig. 26—Three placements of transistor leads.

body (see Fig. 24). The metal will conduct heat away from the transistor and prevent any damage.

An easier way to avoid heating troubles with transistors is to use transistor sockets. These sockets are similar to those used for subminiature tubes and have three or four holes to receive the transistor leads. A typical socket is shown in Fig. 25. The sockets are installed in a rectangular hole cut in the chassis, and a spring metal clip is used to hold them in place.

The three leads of a transistor are called the *emitter*, *base*, and *collector* leads. These leads are identified in a number of ways by different manufacturers. Some makers indicate the collector with a red dot on the side of the transistor. Others put the emitter and base leads close together, with a wider space between them and the collector. Another way of identifying the leads is to place them in a triangular pattern. When this type of transistor is held with the base lead at the top of the triangle, the emitter lead is on the left and the collector is on the right. All of these arrangements are illustrated in Fig. 26.

avoid damaging a transistor place a pair of pliers or tweezers on the wire you are soldering between the soldering point and the transistor

There are two main types of transistors, the PNP and NPN. (These letters indicate the type of germanium used to make the transistor.) They are the electrical opposite of each other. In a PNP type transistor, the collector is connected to the negative side of the battery. In an NPN transistor, the positive side of the battery is connected to the collector. If two transistors are otherwise identical, a PNP can be replaced by an NPN simply by reversing the battery connections.

As with vacuum tubes, there are many different types of transistors. Some are only suitable for audio frequencies, others for low radio frequencies, and still others for high frequencies.

The power transistor is a recent development that holds much promise for the experimenter. This unit will handle enough electrical power to drive a loudspeaker at high volume. As can be seen in Fig. 27, the construction of a power transistor is quite different from that of a conventional transistor. To remove the heat created by the large current passing through the transistor, a *heat sink* must be used. The body of a power transistor is large in order to provide a large surface to contact the chassis. This conducts the heat away from the transistor to the chassis. A power transistor has only two leads coming from the body. One of these is the emitter lead; the other is the base lead. The collector connection is made directly to the metal body. Because this terminal usually is not connected to the ground, an insulator must be installed before bolting the transistor to the chassis. A thin sheet of plastic material or mica can be placed between the transistor and the chassis and the collector connection can be made to the body of the transistor.

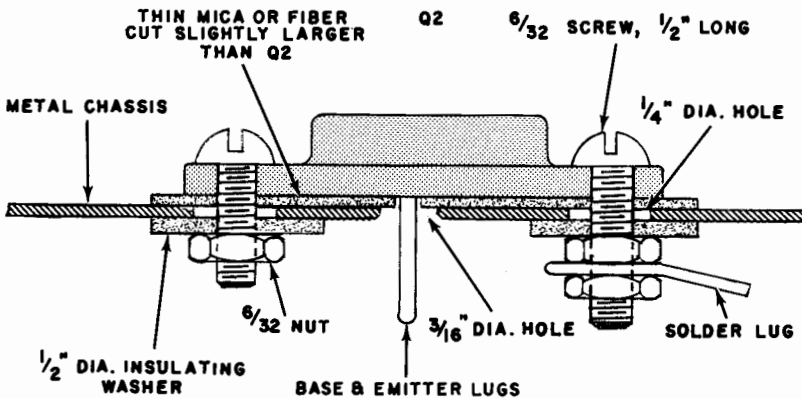

Fig. 27—Construction diagram of the mounting of a power transistor when the collector must be insulated from the chassis.

Crystal diodes are made from the same material as a transistor. They will perform the same function as a vacuum-tube diode does; just as a transistor will perform the functions of a vacuum-tube amplifier. The various types of crystal diodes are shown in Fig. 28. Crystal diodes are sensitive to heat, and the same precautions should be taken as are taken with transistors.

In working with transistors and diodes in experimental circuits, use two or three lug terminal strips as mountings for the transistors or diodes. All connections for the transistor can be made directly to the lugs and then, as the final step in construction, the transistor leads can be soldered to the lugs. This technique provides a firm mounting for the unit and decreases the possibility of damaging the transistor each time a lead is soldered. Use a pair of pliers on the transistor leads while soldering in order to prevent heat from the soldering iron from reaching the transistor body.

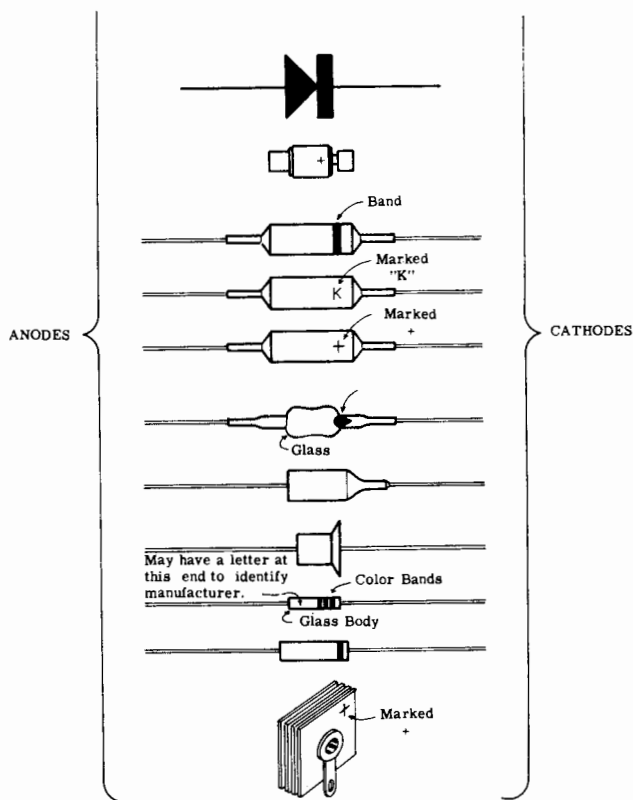

Fig. 28—Crystal diodes and rectifiers are marked in many ways. The symbol for all types shown here is at top.

Resistors and Capacitors

Resistors and capacitors are the most commonly used component in electronic circuits. For each tube or transistor used in the average circuit, there are about four or five resistors and two or three capacitors.

Resistance is the opposition that a unit will offer to the flow of current and is measured in ohms. The schematic symbol for a resistor is a zig-zag line (as shown in Fig. 29). Values of resistors used in electronic circuits range from a few ohms to many millions of ohms. To simplify the writing of large numbers, abbreviations are used. A "K" following a number means that you multiply that number by a thousand. An "M" or "meg" following a number means multiply by a million. For example, a resistor rated at 250,000 ohms could also be labeled as 250K or 0.25 meg. All have the same value of resistance.

The value of a resistor is either stamped on the side in numbers or indicated by colored bands in the standard resistor color code. In order to read this code, you must know the numbers that the colors indicate. These are shown in Fig. 30. The first two bands indicate the first two numbers of the resistance value. The third band indicates how many zeros follow the two numbers. For example, suppose that we have a

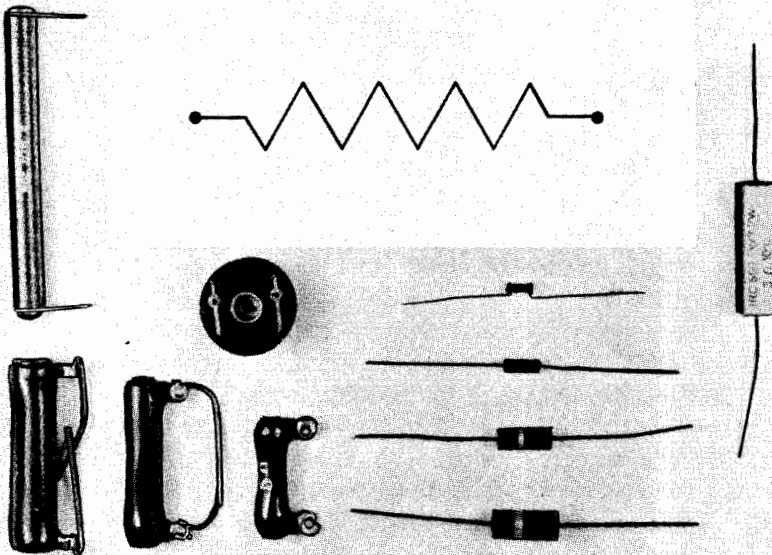
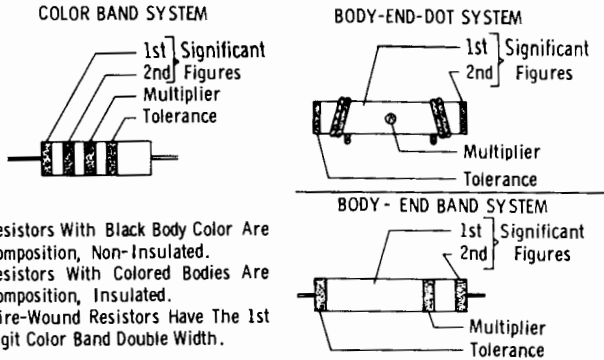

Fig. 29—Fixed resistors are indicated by symbol at top center. The units shown at left are wire wound; those at center are of a carbon composition. The rectangular unit at the right is a 7-watt resistor used in power-supply circuits.



RESISTOR CODES (RESISTANCE GIVEN IN OHMS)

COLOR	DIGIT	MULTIPLIER	TOLERANCE
BLACK	0	1	±20%
BROWN	1	10	±1%
RED	2	100	±2%
ORANGE	3	1000	±3% *
YELLOW	4	10000	GMV*
GREEN	5	100000	±5% (RETMA Alternate)
BLUE	6	1000000	±6%*
VIOLET	7	10000000	±12 1/2%*
GRAY	8	.01 (RETMA Alternate)	±30% *
WHITE	9	.1 (RETMA Alternate)	±10% (RETMA Alternate)
GOLD		.1 (JAN and RETMA Preferred)	±5% (JAN and RETMA Pref.)
SILVER		.01 (JAN and RETMA Preferred)	±10% (JAN and RETMA Pref.)
NO COLOR			±20%

*GMV = guaranteed minimum value, or -0 + 100% tolerance.
±3, 6, 12 1/2, and 30% are ASA 40, 20, 10, and 5 step tolerances.

Fig. 30—Resistor color codes.

resistor with a blue, a grey, and an orange band. Looking at the chart, we find that blue is 6 and grey is 8. Our first two numbers are 68. The third band shows that we must multiply these numbers by 1,000 to get the total value. Our resistor is 68,000 ohms or 68K.

The tolerance rating of a resistor is another important piece of information for the experimenter. The tolerance is the amount (in per cent) that a resistor can vary from the specified resistance value. For example, a resistor with a specified value of 100,000 ohms, 10 per cent tolerance, may actually range in value from 90,000 ohms to 110,000 ohms. Resistors are available in 1, 2, 5, and 20 per cent tolerances. In most circuits the 20 per cent tolerance is good enough, and this is the one that should be used, because the price of resistors goes up as the tolerance becomes closer. In some critical circuits, the closer tolerance resistors are required. If a close tolerance resistor is specified by the author of a construction article, it should always be used. Tolerance is usually indicated on a resistor by a fourth colored band. If there are only three bands on a resistor, tolerance is 20 per cent. If the fourth band is silver, tolerance is 10 per cent; if it is gold, tolerance is 5 per cent. These are the most common tolerances in use. The colors for other resistor values are given in the resistor code chart.

Familiarity with tolerance ratings can be valuable to the experimenter because he can often use this information to substitute a resistor he has in stock for one that he would have to buy. Suppose a circuit calls for a 220,000-ohm resistor with 20 per cent tolerance. Its actual value can range from 176,000 to 264,000 ohms. You could substitute a 240,000-ohm or a 200,000-ohm resistor for the specified unit, providing the substitute has a 10 per cent tolerance. Similarly, a 47,000-ohm resistor can be substituted for a 50,000-ohm unit, and vice versa.

An experimenter should know the wattage rating of resistors. This is the resistor's ability to handle power without overheating. In most small resistors, wattage rating is determined by the size of the unit, and no indication is given. The most commonly used size is the $\frac{1}{4}$ -watt resistor which is about $\frac{3}{8}$ inch long and $\frac{1}{8}$ inch in diameter. The next size is a $\frac{1}{2}$ -watt resistor, about $\frac{1}{2}$ inch long and $\frac{1}{4}$ inch in diameter. A 1-watt resistor is about 1 inch long and $\frac{3}{8}$ inch in diameter. Larger wattage resistors, often used in power supplies, are usually stamped with the wattage rating.

A higher wattage resistor can be used in place of a smaller wattage unit if there is enough room on the chassis. If a circuit calls for a 47,000-ohm $\frac{1}{2}$ -watt resistor, you can substitute a $\frac{1}{2}$ -, 1-, or even 2- or 5-watt resistor of the same resistance value if you don't have a $\frac{1}{2}$ -watt unit on hand.

Potentiometers

Another resistor that the experimenter often encounters is the variable resistor. There are two types of these variable resistors—continuously variable (rheostats and potentiometers) and semifixed adjustable. As shown in Fig. 31, the latter type has movable taps which, once set, are left in position.

Both of these types of variable resistor are rated in exactly the same way as fixed resistors are rated, but the continuously variable type has an additional specification that can be confusing, especially because these units are widely used as volume and tone controls. This additional specification is the *taper* of the potentiometer.

Taper is an indication of the way that the resistance changes as the control knob is turned through its range. For example, if a potentiometer of 500,000 ohms total resistance measures 10 per cent of this value (50,000 ohms) when the control is turned 10 per cent of its rotation, 20 per cent (100,000 ohms) at 20 per cent rotation, 50 per cent at 50 per cent rotation, and so on, the control has a linear taper.

There are about half a dozen standard tapers in use, but the linear and audio tapers are the most important in electronic work. When a

potentiometer has an audio taper, its resistance variation with rotation follows a logarithmic curve. This type of curve follows the curve of your ear's sensitivity to the loudness of a sound. The control used here is the same as that used as a volume control in amplifiers and radios. If a control with a linear taper is used as a volume control, the volume seems to jump from zero to maximum with relatively little rotation of the control.

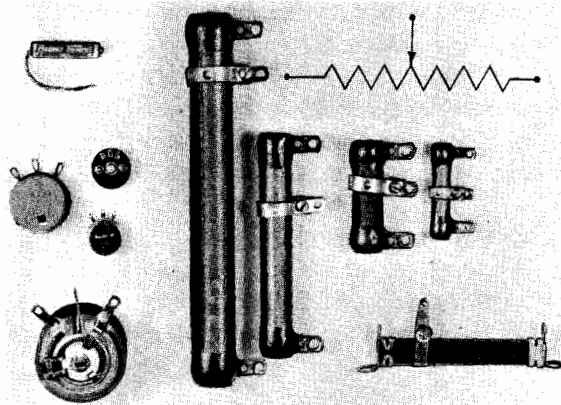

Fig. 31—Variable resistor types. Potentiometers are on the left; wire-wound types which have an adjustable tap are on the right.

Capacitors

A capacitor is made up of two closely spaced conductors (such as metal foil) with an insulator between them. Its schematic symbol shows these two conductors as plates, with a gap between them. Some of the different types of insulation material used are glass, air, plastic, mica, chemical films, and oils. Typical units are shown in Fig. 32.

There are three important types of specifications given for capacitors. These are capacitance, tolerance, and voltage rating. The values are usually stamped on the side of the capacitor. For some types, a color code similar to that for resistors must be used. These codes are given in Fig. 33.

Capacitance is given in microfarads (μfd) or in micromicrofarads ($\mu\mu\text{fd}$). A micromicrofarad is one millionth of a microfarad. Typical values for capacitors range from a fraction of a micromicrofarad to as high as several thousand microfarad, depending on the circuit applica-

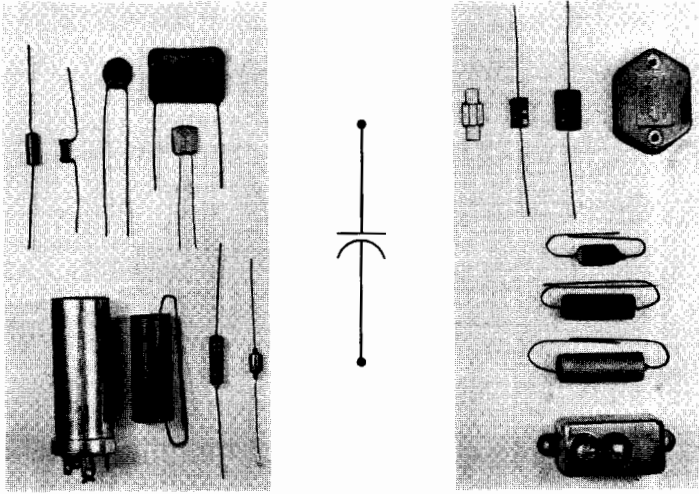

Fig. 32—Various shapes and sizes of fixed capacitors. Capacitor symbol is shown at center. Unit at lower left is can-type electrolytic.

tion. Microfarads and micromicrofarads are often used interchangeably. A capacitor can be marked either $0.005 \mu\text{fd}$ or $5,000 \mu\mu\text{fd}$ and be of the same value. Sometimes, the letter “m” is used to indicate micro.

Except in critical circuits, the tolerance rating of a capacitor is not as important as a resistor’s tolerance. Most capacitors have a tolerance rating of about 20 per cent, although some bypass and filter capacitors may have dual ratings, given as -10 per cent, $+50$ per cent. This means that the actual value may range from 10 per cent below rated value to 50 per cent above rated value.

A capacitor’s voltage rating indicates the maximum voltage that can be applied without breaking down the insulation material and causing a short circuit to occur between the two conductors. Most capacitors are rated with the direct current working voltage (DCWV or WV), which is the average steady voltage that can be applied to it. On some capacitors, the peak voltage is also given.

Capacitors are made in a wide variety of shapes, some of the more common types are the tubular, “postage stamp” mica, disc ceramic, or “bathtub” types.

Electrolytic capacitors, usually used in filter circuits, have a very large capacitance for their size. The connection leads of an electrolytic are always marked with a plus or minus sign to indicate how they are connected to the circuit. The positive lead (+) is always connected to the positive side of the circuit. In “can” capacitors, the outer metal is usually the negative (–) terminal of the unit.

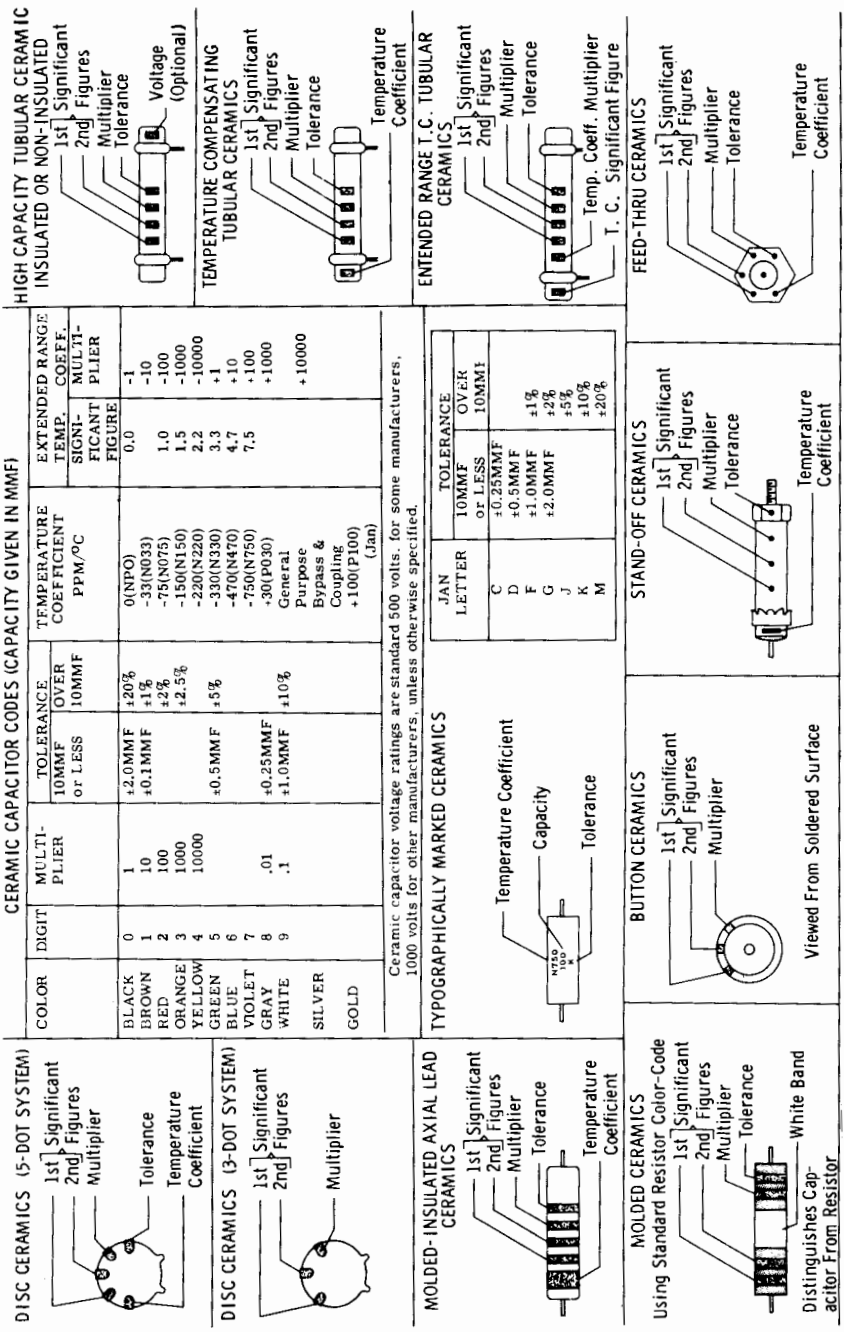

Fig. 33—Capacitor color code.

MOLDED MICA CAPACITOR CODES
(Capacity Given In MMF)

COLOR	DIGIT	MULTIPLIER	TOLERANCE	CLASS OR CHARACTERISTIC
BLACK	0	1	20%	A
BROWN	1	10	1%	B
RED	2	100	2%	C
ORANGE	3	1000	3%	D
YELLOW	4	10000		E
GREEN	5		5%(RETMA)	F(JAN)
BLUE	6			G(JAN)
VIOLET	7			H(RETMA)
GRAY	8			J(RETMA)
WHITE	9	.1	5%(JAN)	
GOLD				
SILVER		.01	10%	

Class or characteristic denotes specifications of design involving Q factors, temperature coefficients, and production test requirements. All axial lead mica capacitors have a voltage rating of 300, 500, or 1000 volts. *or ± 1.0 MMF, whichever is greater.

CURRENT STANDARD JAN AND RETMA CODE

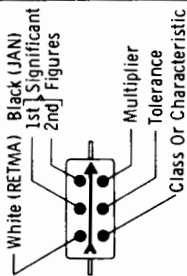

BUTTON SILVER MICA

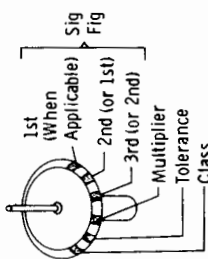

MOLDED PAPER CAPACITOR CODES
(Capacity Given In MMF)

COLOR	DIGIT	MULTIPLIER	TOLERANCE
BLACK	0	1	20%
BROWN	1	10	
RED	2	100	
ORANGE	3	1000	
YELLOW	4	10000	5%
GREEN	5	100000	
BLUE	6	1000000	
VIOLET	7		10%
GRAY	8		5%
WHITE	9		10%
GOLD			20%
SILVER			
NO COLOR			

MOLDED PAPER TUBULAR

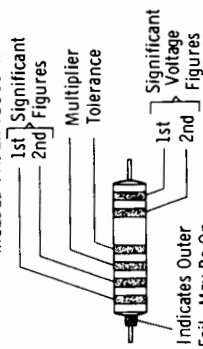

Indicates Outer Foil. May Be On Either End. May Also Be Indicated By Other Methods Such As Typographical Marking Or Black Stripe.

Add Two Zeros To Significant Voltage Figures. One Band Indicates Voltage Ratings Under 1000 Volts.

MOLDED FLAT PAPER CAPACITORS (COMMERCIAL CODE)

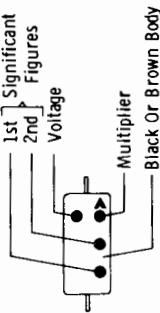

MOLDED FLAT PAPER CAPACITORS (JAN CODE)

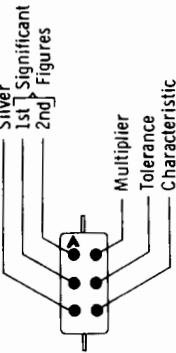

Fig. 33—Capacitor color code (continued).

Most paper tubular capacitors are put together by rolling up a sandwich made of two pieces of metal foil with paper between them. Thus, one foil will be on the outside of the completed roll. This lead is identified by the words "ground" or "outside foil" or by a ring around one end of the capacitor. It is good construction practice to connect this lead to the ground side of the circuit. When this is done, if the outer covering of the capacitor should be worn away or cut by rubbing against the chassis, the foil exposed would be at the same voltage as the chassis.

Variable capacitors (see Fig. 34) are of two general types—those designed for continuous adjustment with a control knob and used as a tuning capacitor and those designed for semifixed adjustment with a screwdriver. The latter are called *trimmer* capacitors if their values are small (up to, say, 100 $\mu\mu\text{fd}$) and *padder* capacitors if their maximum value is fairly large (up to 1,000 $\mu\mu\text{fd}$). Both classes are rated as to minimum or maximum capacitance.

Tuning capacitors have a fixed set of plates, called the *stator*, and a variable set of plates, known as the *rotor*. Air is generally used as the insulating material between the plates, except in small sizes, where thin sheets of plastic may be used. Often, two or more tuning capacitors can be "ganged" together for operation on a single shaft. Each section may have its own trimmer to adjust for minor differences in minimum capacitance.

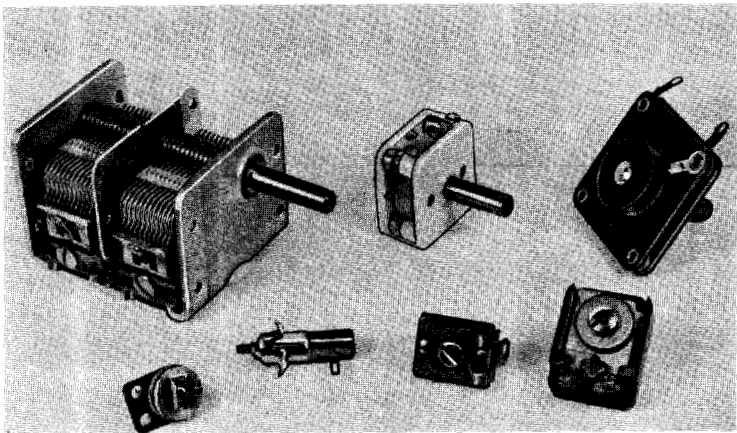

Fig. 34—Variable capacitors. Trimmer and padder types are at bottom.

Trimmer and padder capacitors use thin sheets of mica, ceramic plastic, or glass as the insulator between plates.

In most cases, the two most important characteristics of a fixed capacitor are capacitance and working voltage. Except in filter circuits, the capacitance should be as specified in the original circuit. Working voltage should be equal to or greater than that specified. The type of capacitor is not too important.

For example, if a 0.002- μ fd disc ceramic is specified for a particular circuit, a 0.002- μ fd tubular ceramic, mica, or paper capacitor of comparable working voltage will work just as well in all but some high-frequency circuits.

If space permits, you can always use a capacitor with a higher working voltage than that specified. If a 0.01- μ fd, 150-volt capacitor is called for, you can use a unit rated at 200, 400, or even 600 volts. Never use one rated at a lower working voltage than that specified.

Some alternative symbols used for capacitors are shown in Fig. 35.

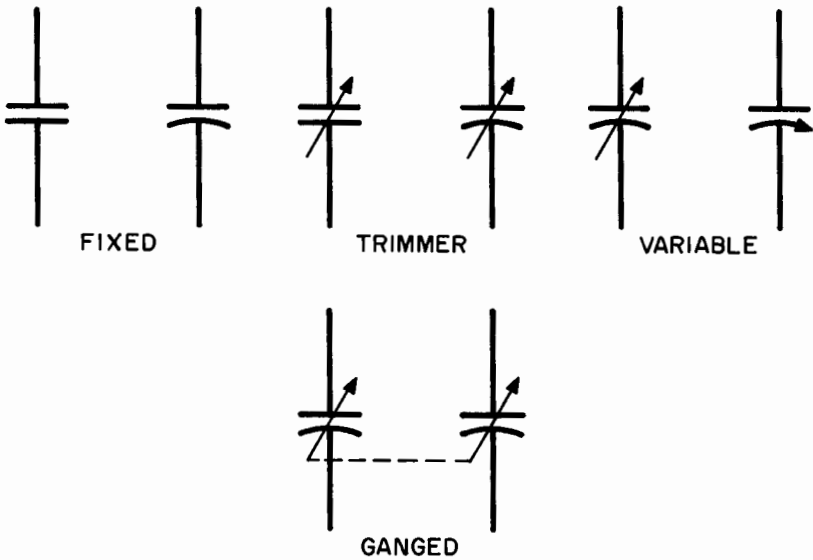

Fig. 35—Symbols for capacitors

Transformers

Basically, a transformer consists of two or more coils of wire wrapped around a core. In the schematic symbol, the input (primary) and output (secondary) windings are shown on either side of the core, as in Fig. 36. If the core is air, nothing is shown between the coils. If

it is an iron core, two or three straight lines are drawn between the coils. As with resistors and capacitors, an arrow through the core or one of the coils indicates adjustability. Antenna coils, which are really an air core transformer, can be mounted either by a simple bolt or can be plugged into a base. Power transformers and output transformers are always mounted on brackets above the chassis or in a cut-out hole in the chassis. The first method is preferred by most experimenters because it requires only drilling mounting holes.

A common type of transformer used in radio is the i.f. transformer. This unit requires a special mounting bracket such as is shown in Fig. 37. After the hole is made in the chassis, the clip is inserted and pushed into slats in the side of the transformer.

Identifying the leads on transformers can be quite a problem for the experimenter. Most air-core coils use enamel-covered wire, so color coding the wires cannot be used. The manufacturer usually supplies a diagram of the transformer with each new unit, but if you have lost this or are using an old transformer, it is necessary to figure out the wiring. The schematic diagram of the circuit you are building will indicate the longer and shorter windings of the coils by the relative length

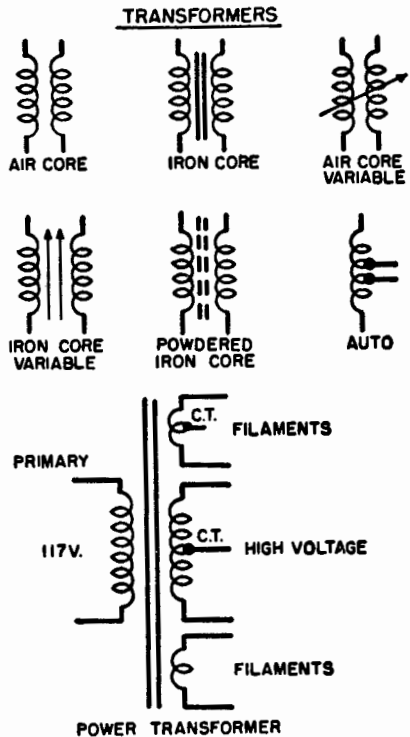

Fig. 36—Transformer symbols.

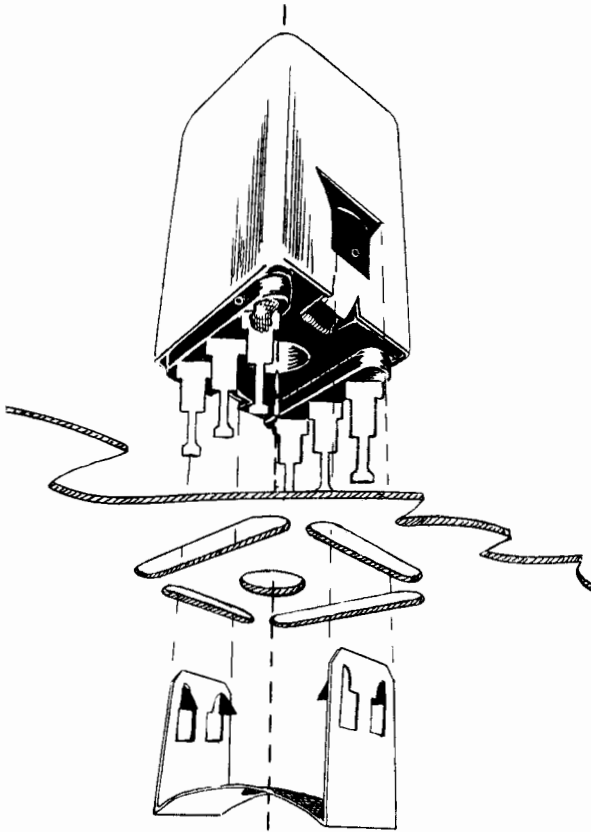

Fig. 37—Transformer mounting. Spring clip fits notches in side of can.

of the coil symbols. After you have wired the coils according to their length, try the unit out. If it doesn't operate, reverse the connections on one of the coils.

It is much easier to determine which wire is which in power transformers. The color code is as follows: Power leads for 110-volt line are black. B+ leads are red, with the center tap of that winding red and yellow. The tube filament winding is yellow, and the filament winding (if any) for the rectifier is white. Output transformers use a similar code with brown and blue for the two input leads and black for the ground side of the output. On some transformers, the output leads are not color coded, but are easy to identify because they are small size enamel or cotton-covered wires. If there is a centertap on the primary of an output transformer, it is color coded red.

Connections to i.f. transformers are made to lugs on the bottom of the unit. These lugs are numbered and the No. 1 lug is indicated by a dot of colored paint on or near that lug.

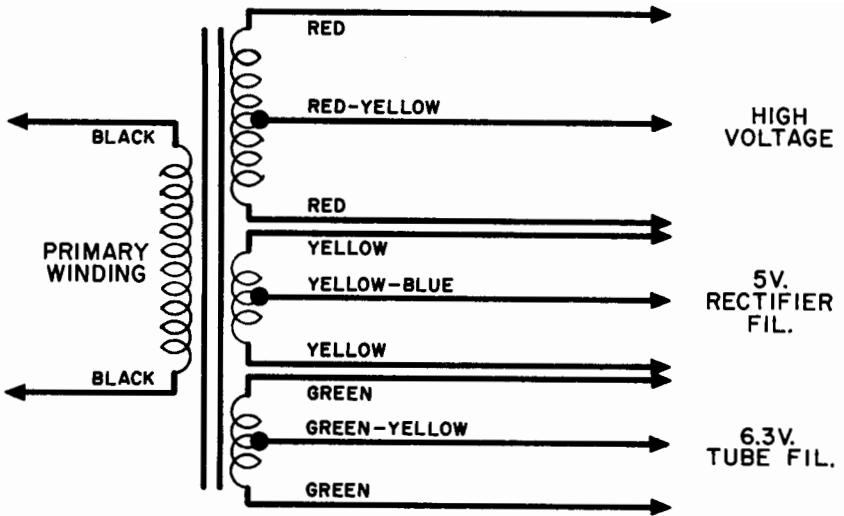

Fig. 38—Wire color coding for typical power transformer.

Where to Get Parts

There are two main sources of parts for the electronic experimenter. The first, and most economical, is the junk box. Every good experimenter should have one. Spreading the word around will produce many friends who are only too willing to give you their old radios and TV sets just to get rid of them. When you get a set home, first remove all the tubes and put them in a safe place where they won't get smashed. Next, get under the chassis and start clipping out resistors, capacitors, coils, and any other part that looks useful. When you are cutting out components try to cut the wire leads as far from the part as possible. This will make them more useful in future projects. Then, sort out the parts, placing all resistors in one box, capacitors in another, etc.

The second source of parts is your local radio parts house. Here you will find all of the components you will need for any project.* Free catalogues are available and will provide you with a handy source of price information so that you can estimate the cost of a particular project.

* Mail order companies such as Allied Radio, Radio Shack, Lafayette, Newark, and Olsen Radio provide extensive catalogues of parts. Because these companies do a nation-wide business, they often have parts that are not readily available at your local store.

3 PLANNING AND MAKING A CHASSIS

THE CHASSIS of your projects is as important to the operation of the equipment as is the electronic wiring. An improperly designed or badly constructed chassis may have a great effect on the operation and useful life of the equipment.

There are two basic chassis types used by the home experimenter, the perforated phenolic board, which is shown in Fig. 39, and the aluminum chassis. The latter can be purchased as a blank box in radio supply shops or can be made from flat aluminum sheet by the builder.

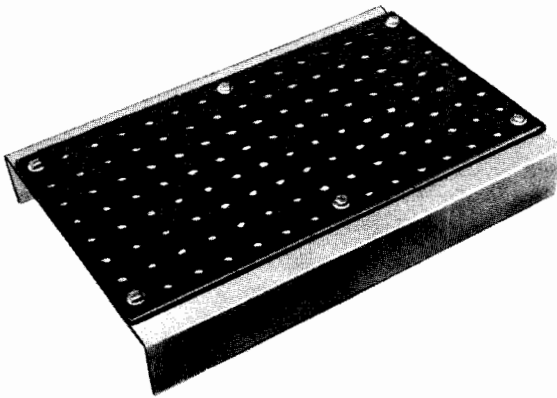

Fig. 39—Perforated phenolic board chassis.

The perforated board is suitable for mounting lightweight components such as transistors or miniature tubes. It is not sturdy enough for use with large transformers for power supplies or output stages. Many experimenters like the phenolic board because it cuts mechanical work to a minimum. The only tools required are a sharp knife and a reamer or round file. With the exception of tube and transistor sockets and potentiometers, most parts can be mounted without tools. For example, to mount a resistor bend the leads at an angle to the body and insert them through two convenient holes in the chassis, as shown in Fig. 40. A slight bend in the leads will hold the part in place until it is soldered. The stiffness of the leads and the soldered joint will hold light parts in place without trouble. Small transformers and variable capacitors can be screw mounted on the boards by using 6/32 or 4/32 screws. If none of the predrilled holes on the board line up with the mounting holes of the parts, it is a simple matter to drill holes where desired with a hand drill, the tip of a knife blade, or an awl.

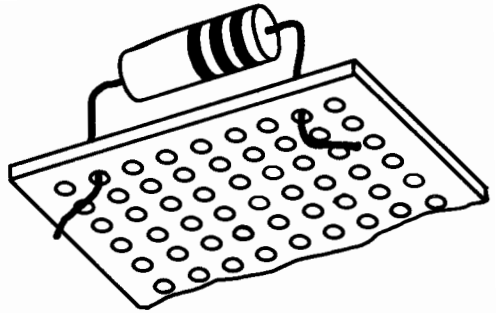

Fig. 40—Resistor mounted on chassis board.

The aluminum chassis requires more working tools than the phenolic board chassis, but it is the only really satisfactory way to mount components in a large project. Some experimenters combine the advantages of the rigidity of an aluminum chassis with the working ease of the perforated board by mounting all of the larger components on an aluminum chassis and wiring the smaller components on a phenolic board. A space is then cut out on the aluminum chassis to fit the board and the board is mounted with a couple of screws. Finally, the wiring between the board-mounted components and those on the aluminum chassis is completed.

Although blank chassis bases are available in steel, it is better to use aluminum because it is an easy material to work and can be drilled, punched, and bent with ordinary hand tools. The one disadvantage of aluminum is that it is not easy to solder without special equipment. However, this is not a serious drawback because a terminal strip, with a ground lug that can be bolted to the chassis, will provide a base to which all grounds can be soldered.

When working with a blank chassis, first prepare a layout showing the location and size of every hole to be punched or drilled on the

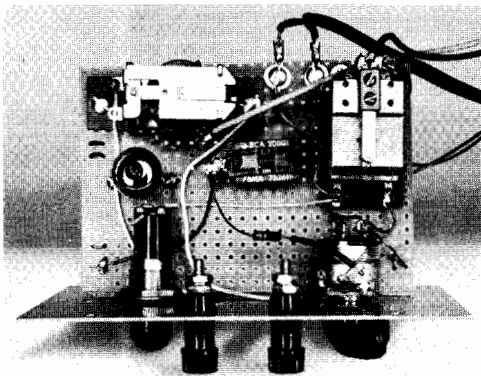

Fig. 41—Complete project wired on phenolic board.

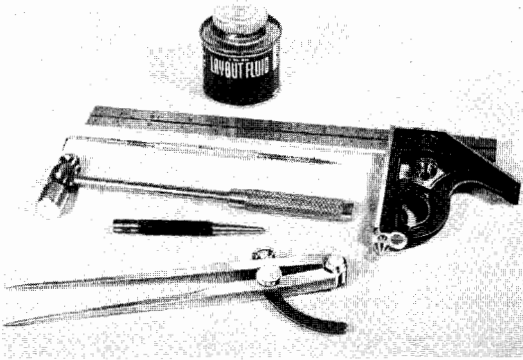

Fig. 42—Tools for chassis layout.

chassis. This layout must then be transferred to the chassis itself before the work can be started. In some cases, you will be able to follow a chassis layout diagram that is part of the project. In other cases, you will have to prepare your own layout from scratch or by following the parts placement in photographs of the completed project.

The first step in laying out a chassis is to determine the parts' positions by arranging all of the major parts, including tube sockets, on top of the blank chassis. After you have done this, move the parts around until the most desirable arrangement is found.

Certain rules should be followed when laying out a chassis in this manner. First, care should be taken not to crowd large tubes (such as rectifiers and power amplifiers) near electrolytic capacitors or wax impregnated coils because excessive heat may easily damage these components. Tube sockets should be arranged to provide reasonably short connections between stages, but the input and output of amplifiers should be kept well separated.

Power transformers, filter chokes, and output transformers should not be bunched together at one end of the chassis. Keep them spread evenly across the chassis in order to distribute the weight of the equipment.

Visualize where volume controls, switches, pilot lights, etc., will be mounted on the front edge of the chassis and be certain to allow enough space. Too often a builder prepares a nice-looking layout only to find that a multi-layer rotary switch falls right over a tube socket, making the unit difficult to wire.

Laying Out the Chassis

When you have the parts in approximate position on the chassis, make a full-size drawing of the chassis top on a sheet of paper. Now

mark in the locations of the parts, taking all of your measurements from one edge of the chassis. Measure the distance between mounting holes on the parts and indicate these on the paper. Now you are ready to go to work on the chassis.

The basic tools required for laying out the chassis include a pair of dividers, a center punch, a small hammer, a scribe, and a combination square or ruler. Not all of these items are essential, but if all are available you will save time and trouble.

Select one corner of the chassis as your measuring base. Make all of your top-of-chassis measurements from the two sides comprising this corner. Now draw center lines for the various holes directly on the chassis, using the scribe and ruler as shown in Fig. 43. (Note how the layout fluid makes the lines stand out.) Use only enough pressure on the scribe to make a visible line on the surface of the metal.

When a single dimension is to be repeated a number of times, the divider can be set to this measurement and used to mark off all similar dimensions. The final step is to carefully center-punch all holes to be drilled.

Hold the center punch firmly at the point to be marked and tap it lightly with a hammer. Use only enough force to make a distinct mark on the metal. Too hard a blow will cause a large dent and may deform the chassis. A block of wood placed under the chassis while center-punching will prevent bending of the chassis (see Fig. 44).

With the chassis laid out, the next step is to drill the holes for the components. Because aluminum is a fairly easy material to work, practically all of the drilling and cutting can be done with ordinary hand tools. However, there are some additional tools that will make the whole job easier. You should have a drill (electric, if possible), a set of drill bits, a hammer, a half round, and a flat file. A fly-cutter, hole saw, or chassis punch is also a good investment. These tools can be used to make large holes for tube sockets and transformers. Although you can make holes for tube sockets with a drill and filing, a punch or cutter will save considerable muscle power. A fly-cutter is a pointed bar that fits into the chuck of a hand drill. An adjustable arm with a cutter blade can be set for any diameter hole. These cutters are available with square shanks for use with a hand brace or with round shanks for power drills. Because the cutter is adjustable, you will need only one to handle almost all of your work.

The chassis punch is easier to use than the fly-cutter, but it is not adjustable. You will need a separate punch for each size hole. To use a chassis punch, drill a small pilot hole at the center of the larger hole to be cut, attach the base of the punch to one side of the hole

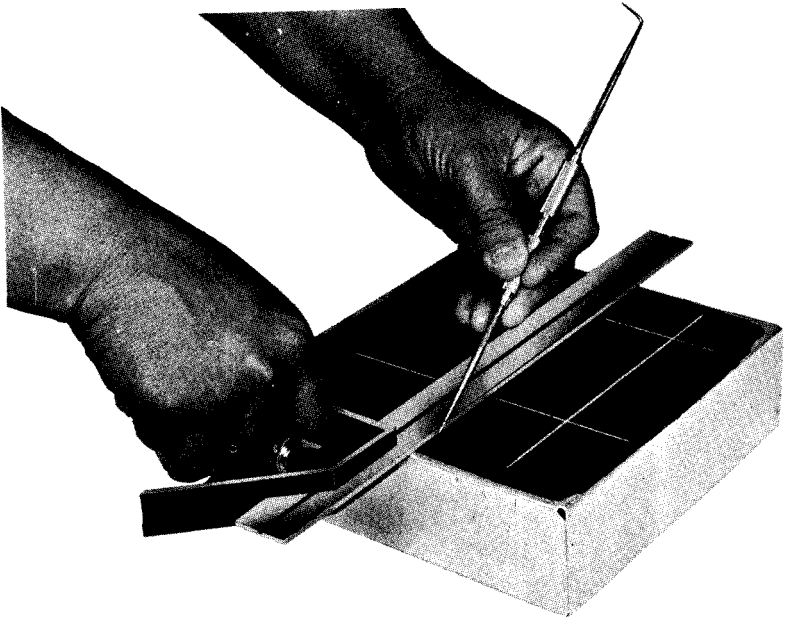

Fig. 43

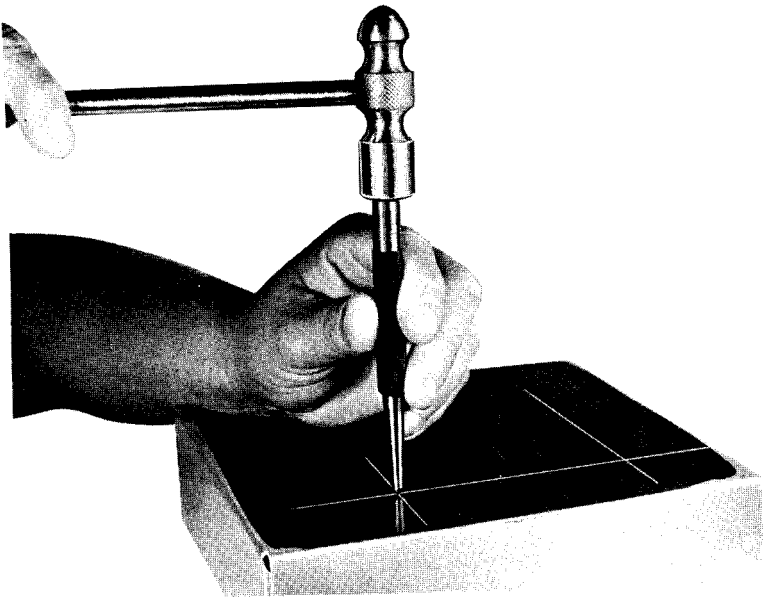

Fig. 44

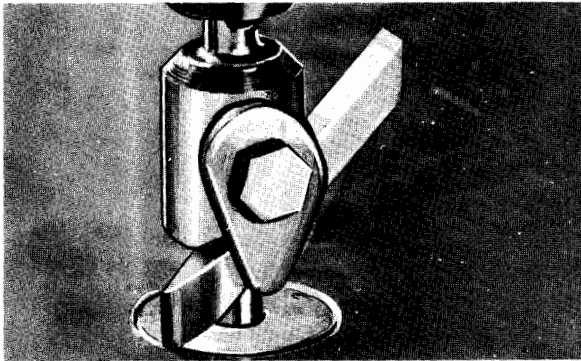
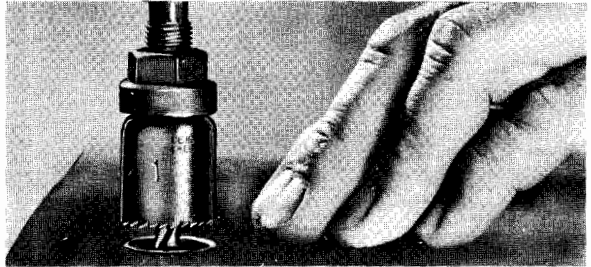
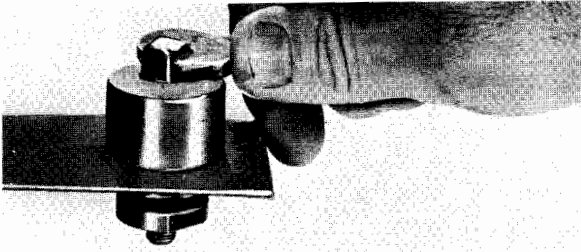

Fig. 45—Four ways to drill large holes.

and the cutter to the other, then tighten the screw. The screw pulls the base and punch together, cutting the metal between them. The result is a perfectly clean hole. These punches come in a wide variety of sizes, including square shapes for making transformer mounting holes and windows.

The hole saw is actually a hack-saw blade mounted around a drill that is used as a centering guide. Hole saws are not adjustable. They usually come with a set of cutters that will handle the most common hole sizes.

If you don't have the money available to purchase the special hole cutters described here, there is a simple method that can give you as good results with a bit more work. The procedure is as follows: Use a compass to mark the size hole required on the chassis. Then make another circle that is smaller than the first by the radius of the drill you are going to use. For instance, to make a 1-inch hole draw a circle 1 inch in diameter. If you are going to use a $\frac{1}{8}$ -inch drill, make the second circle so that it will be $\frac{1}{16}$ inch smaller than the outer circle. With a center punch, mark points around the inner circle, about $\frac{1}{8}$ inch apart, and drill through each point. Now, with a small coping saw, cut around the circle connecting the holes together. The job is finished with a file. Clean away all of the high spots around the edge of the hole and shape it to the proper size.

Making a Chassis from Scratch

Thus far we have talked about planning and laying out our equipment on commercially available aluminum chassis. This is, by far, the easiest way; but it is expensive, and our layouts are limited to whatever shape and size chassis are available. Chassis can also be made from aluminum stock, at low cost and with a minimum of special tools.

Use 24-gage aluminum, which is available at most hardware stores. This gage material can be bent to form with only hand pressure, but will make a chassis sufficiently sturdy for almost any experimental application.

There are two construction steps. First a top plate is cut to size, then four side pieces are bent to shape and bolted to the top plate. The side members can be formed using two pieces of wood. The metal is clamped between the two strips of wood and bent to shape on a flat surface (see Fig. 46). Alternative chassis arrangements are shown in Fig. 47. These can be cut from one piece of 24-gage stock and bent to shape over a sharp edge such as a table or vise. Figs. 48–53 show materials from which chassis can be made.

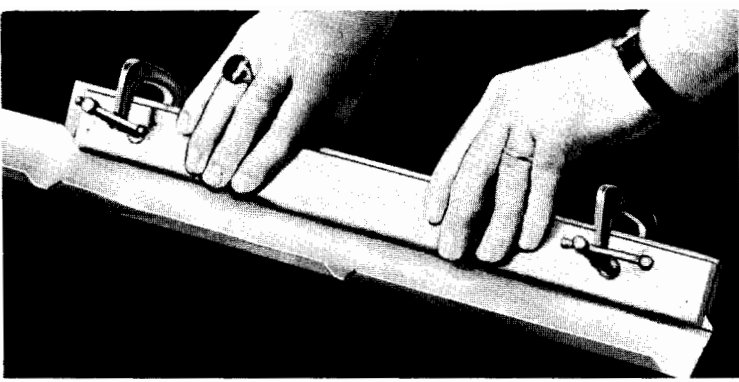

Fig. 46A—Bending sides of aluminum for chassis.

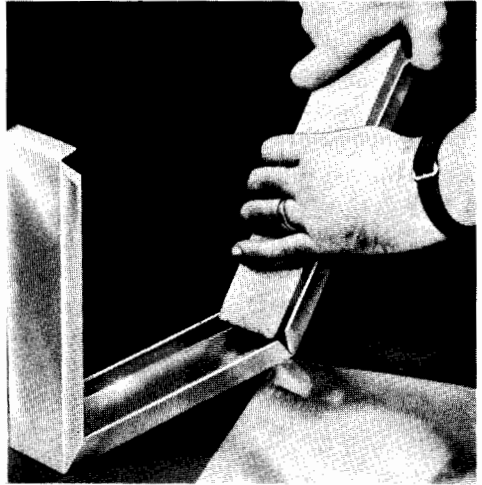

Fig. 46B—Bending aluminum with notches for desired chassis height.

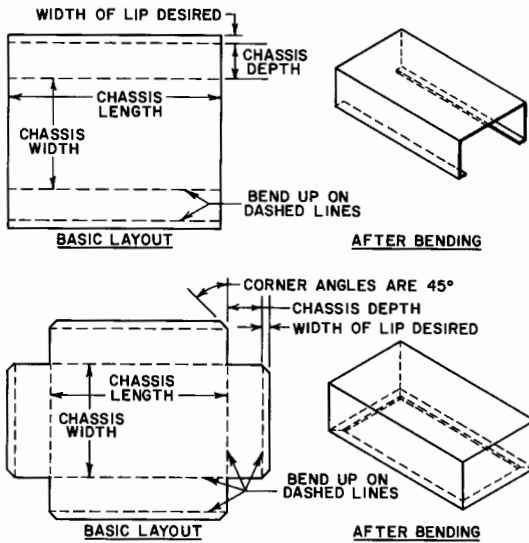

Fig. 47—Alternative chassis arrangements. Upper shows layout for chamele-type chassis. Lower shows box-type layout.

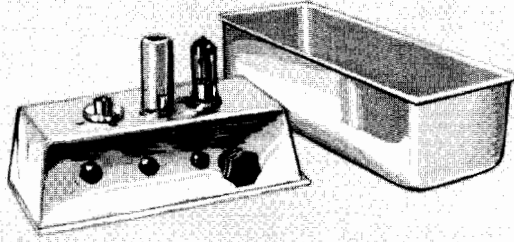

Fig. 48—Household pans used for chassis bases.

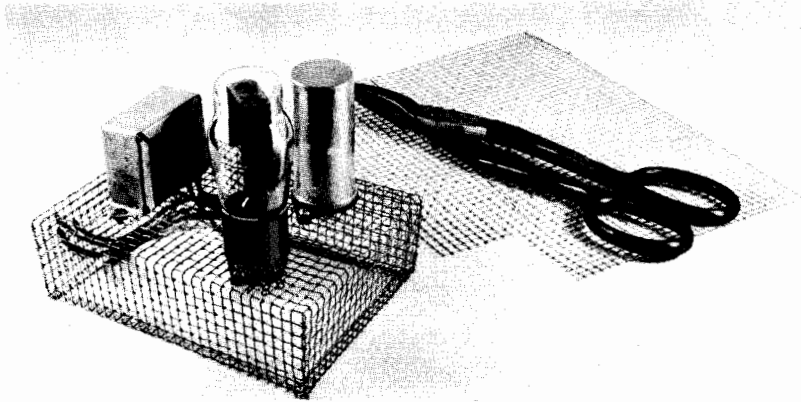

Fig. 49—Hardware cloth cut with metal shears and shaped to form a chassis. Corners are held together by soldering or by wrapping ends of wire mesh together.

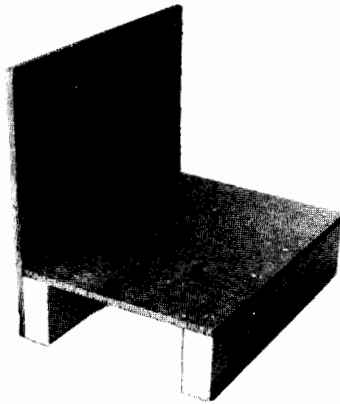

Fig. 50—Masonite used for both chassis and front panels where shielding is not critical.

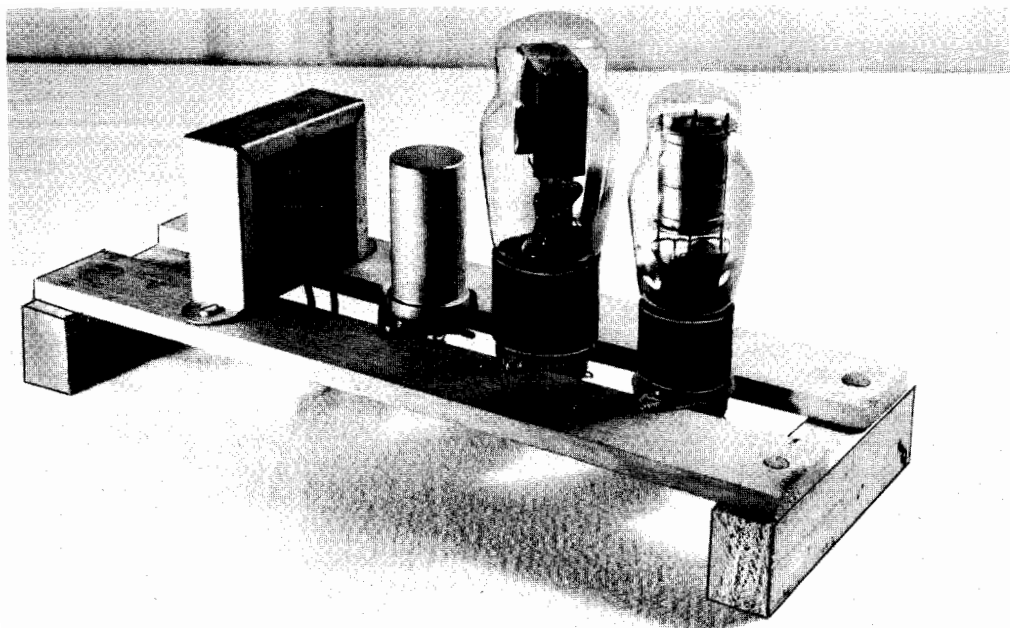

Fig. 51—Scraps of wood used to make a chassis base.

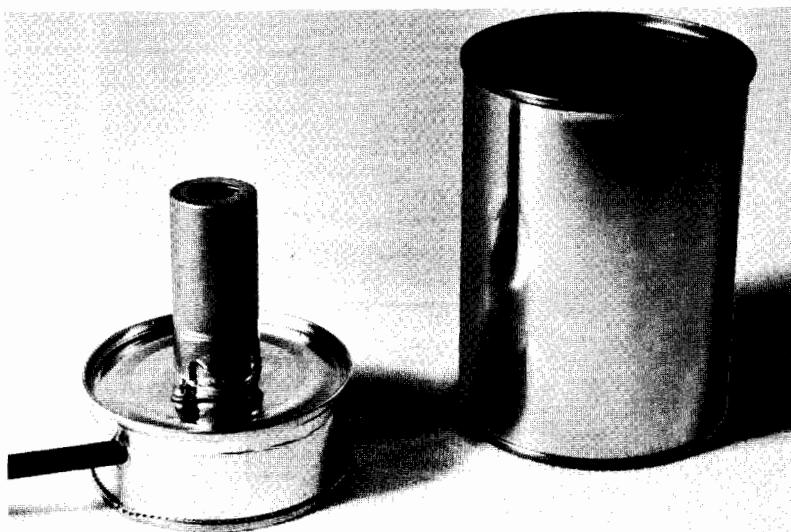

Fig. 52—A discarded tin can makes a good chassis base for one-tube circuits.

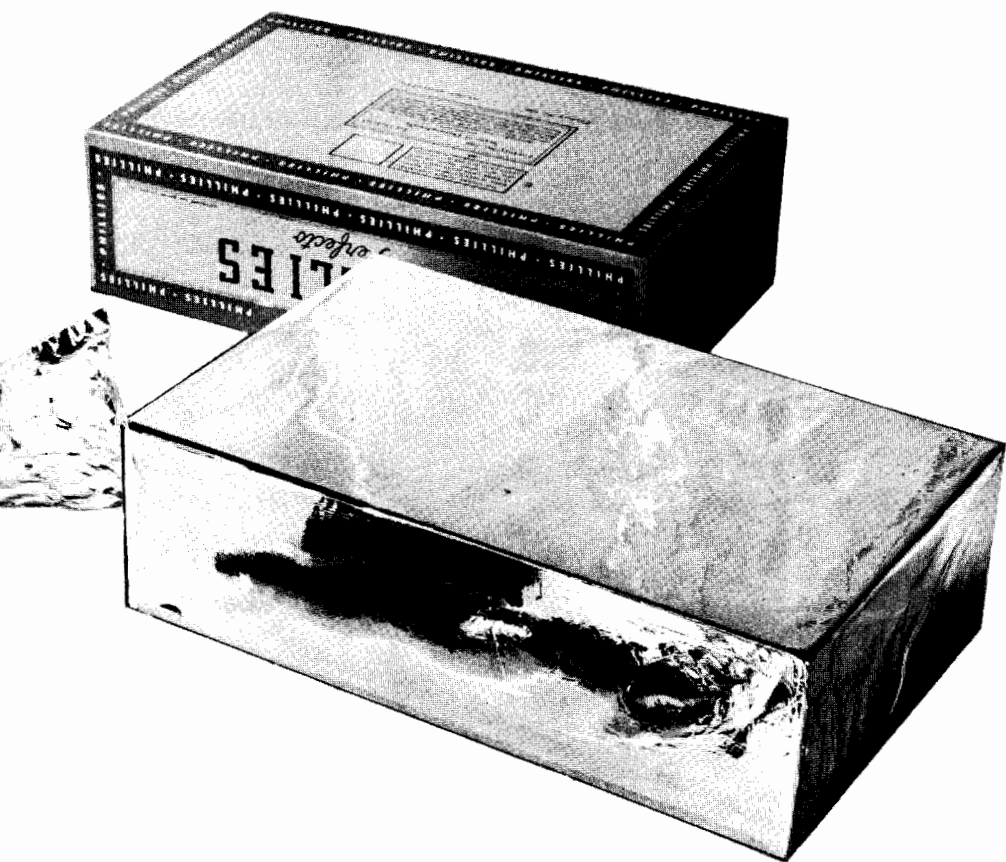

Fig. 53—A cigar box covered with aluminum foil makes a good shielded chassis.

Dressing Up a Chassis

Although the chassis on most projects will be hidden from view, the front control panel is there for everyone to see. There are two ways to make the panel professional-looking: First, satinizing; second, the application of decals. The soft satin appearance of commercial equipment is not a secret process and is easily duplicated in the home shop by the use of chemicals obtained from commercial chemical shops.

Clean the aluminum with paint thinner to allow proper action of etching chemicals. Then dip it into a solution of warm water and sodium hydroxide or Okite No. 160. The aluminum will start to bubble. After a few minutes wash it in water, then dip it into a solution of sodium dichromate. This last dipping will remove any black stains that may have appeared.

Photo-developing trays can be used for dipping small plates or chassis subpanels, provided that the solutions are not left in the trays for a long period. Two cautions in using this technique: Work in a well-ventilated room and use tongs to handle the parts. Hydrogen gas fumes are given off during the etching process, and ventilation will prevent them from accumulating in the room. The tongs will prevent caustic solutions from burning your skin.

A simpler method of finishing a panel is to use crackle finish paints available from parts houses. When applied to the surface, these paints dry to a rough finish similar to that on many professional pieces of equipment. They are available in handy spray cans.



Fig. 54—Decals installed on panel front.

Decals are available in many forms to label the various switches and controls on your project. They are easy to install, and provide a useful purpose as well as a professional-looking appearance. Cut out the desired lettering, soak it in water, and then apply it to the wet surface of the panel. Next, smooth out any air bubbles that may be trapped under the decal and let it dry. Spray two coats of plastic over the surface after it has dried thoroughly. The decals will then be in place permanently (see Fig. 54).

4 WIRING THE CIRCUIT

IN CHAPTER 2 we saw that each electronic component had its own schematic symbol. We will now look at some of these symbols as they are used in a circuit and see how to put the circuit together.

The schematic diagram is the heart of any electronic project. If you can read and understand it, you can build the whole project with little or no written instructions.

Pictorial diagrams that show a picture of the parts and the wires that connect them are frequently given along with the schematic diagram. These pictorials are suitable for the beginner or for a simple project. But, as projects become more complicated, the pictorial diagram becomes useless. One of the big problems with pictorials is the fact that the man drawing the diagram has little choice as to where he places the parts. This results in a tangle of wires as the drawing gets more complicated.

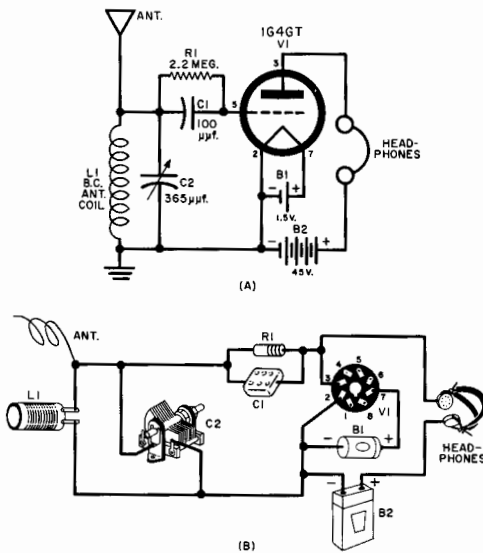

Fig. 55—Schematic for a simple radio.

A schematic diagram, if it is drawn right, will have few crossing wires. There are certain standard ways of drawing these diagrams that make them easy to follow. All stages of a circuit are laid out in a straight line, with the input on the left and output on the right. Auxiliary circuits, such as oscillators, are drawn below the tube they affect. High-voltage wiring, such as the B+ wires, is usually drawn above the tube;

low-voltage wiring (filaments or grounds) is drawn below the tube. Power-supply wiring is usually off to one side, at the bottom of the drawing.

It would be impossible to follow these conventions in a pictorial diagram. Therefore, each pictorial is a one-shot affair as far as learning is concerned. But, every schematic understood is a step toward better understanding of electronics.

Placement of the symbols on the schematic diagram has no relationship to the actual placement on the assembled chassis. The schematic only shows the connections of the parts. Where the parts go on this chassis is up to you or to the man who designed the equipment.

In a schematic, connections between wires are shown by a dot. If the wires cross, but do not connect electrically, no dot is used. A schematic for a simple receiver is shown in Fig. 55A. If we mentally substitute the parts indicated by symbols it would look something like Fig. 55B.

The first step in building the receiver is to lay out the chassis and mount the parts that are to be screwed to the chassis. These include the tube socket, variable capacitor, and antenna coil. Because the set is battery operated, mount a screw-terminal strip to which the batteries can be connected. A set of binding posts can be used to connect the headphones. With all the mechanical work done, we can proceed with the wiring using the schematic as a guide.

The left side of the diagram shows that the antenna, one side of the coil, and one side of the tuning capacitor should be connected together. Two pieces of wire will take care of this. Next, the battery ground terminal, the other side of the coil, and the other side of the tuning capacitor are all connected together. (The terminal on the tuning capacitor attached to the frame is always the ground side.)

The schematic also shows that the mica capacitor C1 and the resistor R1 should be connected directly together (in parallel). One end of the combination goes to pin 5 of the tube socket; the other end goes to the end of the tuning capacitor that is connected to the antenna.

Number 3 terminal goes directly to one side of the headphones. The other side of the phones goes to the + terminal of the battery. Hook this wire to the terminal of the battery terminal board that was mounted on the chassis.

There are two remaining connections to the tube socket. Socket pin No. 2, the "A-," the "B-," and ground are all connected together. In the AM broadcast band, where this set will operate, it is not important where the wires join, but they must all be connected together. A wire from socket No. 2 should go to the frame (ground) side of the

tuning capacitor. A wire from the frame should go to the A- and B-lugs on the terminal strip.

The wiring is finished, except for pin No. 7. That goes to the + side of the A battery. Connect a wire to that lug on the terminal strip. Label the connections on the terminal strip with a pencil so that the batteries will be hooked up properly.

Clip a wire from a water pipe or bedspring or something onto the "ground" terminal, drape 10 feet of wire over the window frame for an antenna, connect the phones, and, presto, the job is completed. You should have an operating radio. That's all there is to using a schematic diagram!

Trouble Shooting

Schematics are also useful after you have finished building a project. If the circuit doesn't work on first try or if something should go wrong with one of the components at a later date, the schematic will be useful in tracking down the cause of the trouble. It is a good idea to keep a file of schematics for all projects so that you can refer to them easily if trouble occurs.

When a circuit does not work after the wiring is completed, there are three main reasons—poorly soldered joints, wiring errors, and defective components. The fastest way to locate the trouble is to make a systematic check of the wiring and soldering. First inspect each terminal for signs of poor soldering technique. This can be found by looking for a joint that has a granulated rough surface instead of the smooth shiny surface of a good joint. When you find a cold solder joint, touch it with a hot soldering iron until the solder begins to flow.

The next step is to make a quick check of the wiring. A fast way to do this on simple projects is to look at the schematic and count the number of wires connecting to each major terminal, such as tube socket pins and terminal strip. Then look at that terminal in the wired circuit and check to see that the numbers match. The best way to check wiring, although the most time consuming, is to check each wire on the schematic and then locate it in the circuit. Check to see that it is connected between the proper points and then cross it out on the schematic with a colored pencil. Start at the left of the schematic and work across to the right, marking out the wires as you go. This method should show up any wiring errors. The procedure used for the circuit in Fig. 55 was as follows: Antenna goes to one end of coil (check wiring). From the same terminal, lead goes to pin 5 of tube through a capacitor and resistor in parallel (check wiring). The variable capacitor is connected across coil terminals and second terminal of coil goes to

ground (check wiring). This procedure is followed until all the wires on the diagram have been accounted for.

If you have a voltmeter and ohmmeter handy, they are very useful in locating the source of trouble in a circuit. (Some circuits for building your own meter are given in Chapter 8.) By using a meter, you can narrow down the trouble from the whole circuit to one individual spot. For example, one of the first things to check is the B+ voltage throughout the circuit. Start at the source of this voltage, the power transformer. Using the voltmeter, check to see if there is voltage present at the output of the transformer. (This is a.c., so use the proper meter setting.) If there is voltage at this point, move to the output of the rectifier (switch your meter for d.c. reading). If everything is all right there, move your meter to the plate terminal of each tube. If you find a place where there is no B+ voltage, you know that the trouble is between there and the rectifier. This is where the schematic diagram can be useful. Trace the circuit on the schematic from the rectifier to the point where there is no voltage. Then work back from the plate of that tube, making voltage measurements on each side of the components. When you find a part that has no voltage on the plate side and does have voltage on the rectifier side, you have found the defective component.

Another check point is the filament circuit of the tubes. First check with the voltmeter to make sure that there is filament voltage being supplied by the transformer (a.c. again). Then connect the meter across the two tube socket pins that are connected to the tube filaments. The voltage reading here should be about the same as the first two digits in the tube number (for a 6SN7—6.3 volts, for a 12AU6—12.6 volts, for a 50L6—50 volts). If all of these voltages are O.K., you can be sure that the filament wiring is all right; but you still have to check the condition of the filaments inside the tube. To do this, use an ohmmeter. Remove the tube from the socket and set the ohmmeter to its lowest scale. With the test leads of the meter connected across the filament terminals of the tube, there will be a low reading on the scale if the tube is all right. If the filament wire is broken inside the tube, there will be no movement of the meter pointer.

5

MAKING PRINTED CIRCUITS

PRINTED CIRCUITS have many advantages for the home experimenter. They can eliminate the need for much drilling and bending of metal chassis. The printed circuit, which is simply a sheet of phenolic plastic covered on one or both sides with copper foil, provides a chassis for mounting components and also provides most of the interconnecting wiring for the parts. Soldering the components into the board not only mounts them physically, but also connects them into the circuit electrically.

Of the various printed-wiring techniques now in use, etching is best suited for home use. An additional method, stripping, is also useful in the home shop, but it is limited to projects where the wiring is simple. Its main advantage is that the only tools required are a hand drill, a center punch, and a heavy-duty hobby knife.

In printed circuits, generally speaking, all components are mounted on one side of the base. This is not a hard-and-fast rule and can be varied to suit individual needs. The components can be mounted directly in small-size holes drilled into the copper strip, or an "island" can be formed which is slightly wider than the strip and an eyelet inserted.

Lightweight soldering irons are a must for printed circuits. They should be about 25 to 50 watts and should be used with a fine low-heat solder. Heavy irons and high-temperature solder may cause blisters which would pull the copper laminate away from the phenolic base.

Laying Out the Circuit

The basic steps in all printed-circuit techniques are similar. First the circuit must be drawn on paper; then the lines are transferred to the copper-foil; finally the foil is removed from the phenolic, leaving only the desired wiring pattern. It is in this last step that the major differences in technique occur.

To make a circuit layout, start with the schematic wiring diagram of the project you plan to assemble. Redraw the schematic one or more times, trying to eliminate all circuit wiring crossovers. When you have a tentative circuit, gather the components you plan to use and make a full-size scale drawing of the final circuit.

Locate components where they will serve to bypass conductor crossovers which are not easily eliminated. Individual leads or "wires" should have a thickness of at least $\frac{1}{32}$ inch, with the spacing between adjacent conductors not less than $\frac{1}{32}$ inch. Thicker leads can be used

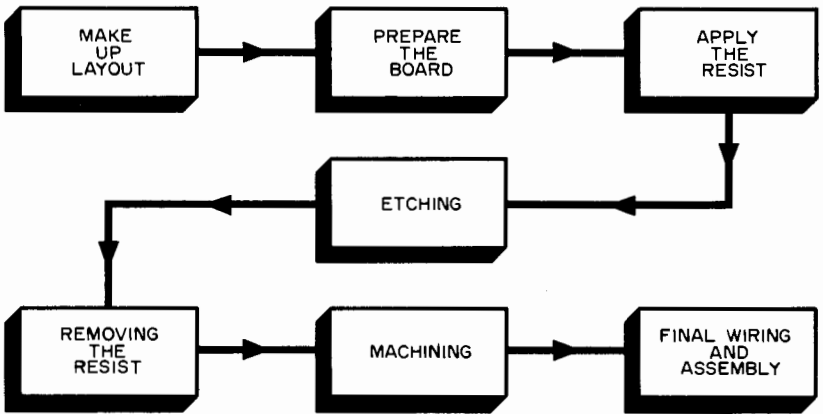

Fig. 56—Basic steps in the preparation of an etched circuit board.

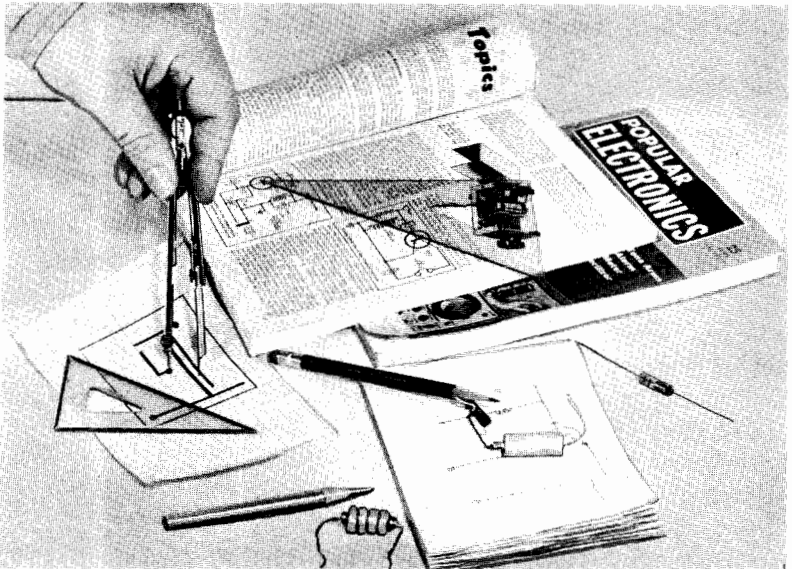

Fig. 57—To make up a printed-circuit layout, start with the schematic diagram of the project you plan to assemble. Redraw it until you have eliminated all circuit wiring crossovers.

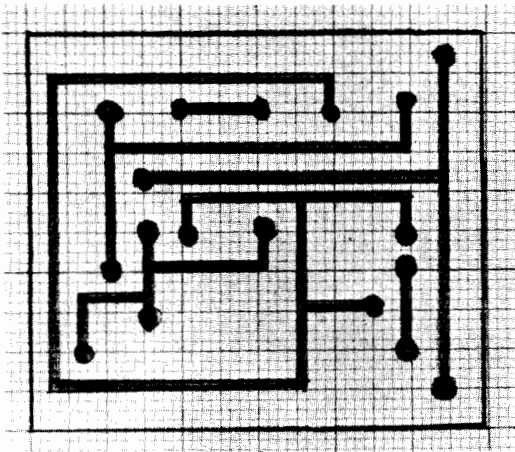

Fig. 58—Typical etched circuit layout.

if desired, and you may find it easier to work with $\frac{1}{16}$ -inch- or even $\frac{1}{8}$ -inch-wide conductors on the first few boards you make up.

Where components are to be mounted or leads attached to the board, draw small circles. Entire patches of foil conductor can be used for shielding, although it is generally best to break up solid areas with diagonal bars. The spacing between adjacent bars may approximate or be slightly greater than the width of the bars. Where 90-degree turns are made, the conductor may follow a smooth curve or make a sharp bend, as preferred. Where eyelets are to be used, plan on holes large enough to accommodate them. Use slightly smaller holes when leads are to be attached directly to the copper foil.

In general, component and wiring leads can be soldered directly to the copper foil for permanent connections, but if the leads may be removed often, plan on using copper or brass eyelets at such points. Space component mounting holes for the actual parts you plan to use. If the components are to be mounted by their leads (resistors, capacitors, and small coils are generally mounted in this fashion), space the mounting holes with the thought of using a gradual bend in the component leads instead of a sharp bend close to the body—sharp bends may cause the leads to break off or may place an undue strain on the component. You will find that graph paper is useful for making up the scale wiring layout.

A typical printed-circuit board for a wiring layout is illustrated in Fig. 59. This layout has been designed to illustrate important points to remember when making up your own layouts and does not represent a specific circuit.

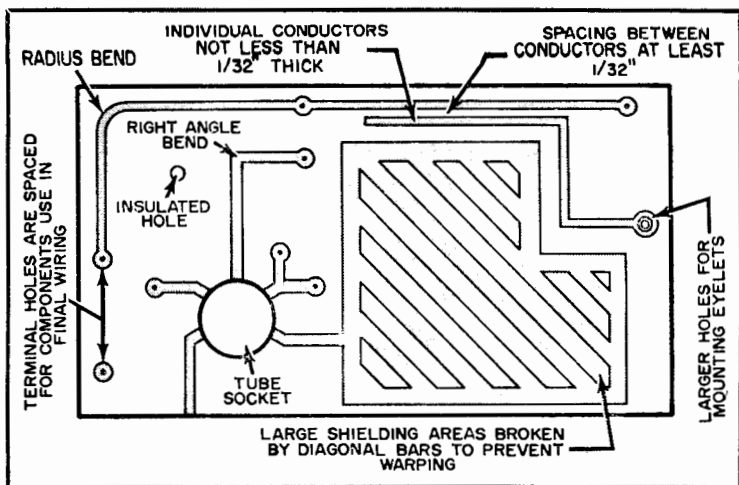

Fig. 59—Typical printed-circuit board.

Upon completing a circuit wiring layout, check and double check for errors. While still in the layout stage, an error may be corrected simply by erasing and redrawing the layout. But once the board is etched, it may be necessary to make up an entirely new board to correct mistakes.

The copper-clad phenolic board and other materials can be purchased individually, or in kits, from radio supply houses. At the beginning, however, it is best to purchase a complete kit of materials. After you have gained a little experience in making up circuit boards, you can purchase individual items in the quantities needed.

Depending on the circuit layout, use either single-sided (single-clad) or double-clad boards. But until you have gained experience, you will find it best to stick to simple layouts and single-clad boards.

Cut a piece of the copper-clad board to fit your circuit layout, using a fine-toothed hacksaw, a jigsaw, or a scroll saw. Cut from the copper side, and back up the thin phenolic board with a piece of hardboard or plywood. Any large holes or cutouts needed (for tube sockets, for example), should be cut at this time. Use a hole saw or fly cutter for cutting large, round holes. Do not use a conventional chassis punch; this may crack the board. Only the large holes and cutouts should be made at this time. Smaller holes can be drilled after the board is etched.

After the board has been cut to size and the rough machine work completed, clean off dirt and tarnish from the copper surface, and roughen it slightly to permit the etchant to get a better "bite" on the foil. Do this by scrubbing the surface with a stiff brush and an abrasive household cleanser. Sprinkle the household cleanser lightly on the foil

and scour vigorously with a slightly dampened cloth. With the surface properly prepared, the copper should be bright and shiny and should have many small scratches that are visible when the foil is examined through a small magnifying glass. Rinse and dry the prepared board.

Obtain a few sheets of "pencil" carbon paper from your local stationery store. Cut a piece to fit your circuit board and attach the carbon paper and scale wiring layout to the board with Scotch tape. Make sure the layout cannot shift its position. Finally, using a moderately hard pencil, trace the layout onto the copper foil.

Locate small mounting holes by pricking the copper right through the layout and tracing carbon, using a small center punch or a sharp scribe. In order to avoid cracking the board, use hand pressure or a very light hammer tap when locating these holes. Back up the board with a solid piece of hardboard or wood. Double check your tracing before removing the layout sheet and carbon paper.

After the circuit layout has been transferred to the copper-clad board, the acid "resist" can be applied. For experimental "single-shot" circuits, two types of resist are popular: (1) ink resist and (2) tape resist.

Ink resist is an asphalt-based, acid-resistant paint or ink. It is supplied as a part of most printed-circuit kits, and, also, is available from many art supply houses. Apply ink resist to the copper foil using a small ruling pen, a small brush, or a "Speedball" pen. Cover all parts of the wiring layout, because only those parts of the copper foil covered by the ink will remain after etching. Allow the ink to dry.

Ordinary plastic-base Scotch electrical tape makes an excellent tape resist. Narrow strips can be cut from the standard width using a sharp knife or razor blade. Small circles, for terminal connections, can be punched out with a hand paper punch. The tape is applied to the copper foil to cover the traced wiring paths on the layout pattern, then burnished down in place with a soft hand tool. A good burnishing tool can be made quite easily by rounding the end of a wooden dowel peg.

Double check the circuit board after applying the resist. Compare it to the original layout. If you find you've made an error, correct it. Ink resist can be removed by using a hard (ink) eraser; tape resist is simply peeled off. Reapply the resist to correct the error.

A ferric-chloride solution (FeCl_3) is used to etch the board. This is available in either liquid or powdered form. It can be purchased at photoengraving supply houses in liquid form and from some drug stores and chemical supply houses in powdered or lump form. If you use the etchant from a kit, follow the instructions furnished with it.

If you obtain a ferric-chloride solution from a photoengraving supply house, it will be listed as "42 per cent ferric-chloride." This solu-

tion is rather thick and should be diluted before use. Add plain water in proportions of one-half pint of water to one quart of solution.

If you obtain the ferric chloride in powdered form, dissolve it in a Pyrex glass or an enameled container. The proper ratio is approximately 3 ounces of ferric chloride to 6 ounces of water. The dissolving action is exothermic—that is, heat is evolved as the ferric chloride goes into solution—so don't worry if the solution heats up slightly.

Use care when working with the etchant. It can stain clothing. Although it is not especially dangerous, the ferric-chloride solution is "bitey" and may irritate sensitive skin. Wear rubber gloves when working with it.

The actual etching is carried out in a small, flat tray that is similar to those used by photographers. A shallow Pyrex cooking dish makes an excellent tray. Either "hot" or "cold" etching can be employed. The hot etching technique is slightly faster than cold etching. For the hot etching method, obtain a small hotplate and either a Pyrex dish or tray or an enameled metal tray. If you use the cold method, a shallow plastic box or tray can serve as the etching container.

To etch the circuit board by means of the "hot" method, pour a sufficient amount of the etchant into the tray to cover the circuit board to a depth of about $\frac{1}{4}$ to $\frac{3}{8}$ inch. The actual amount of etchant used is not critical as long as the board is completely covered. If in doubt, always use a larger quantity. Place the tray on the hot plate and turn on the heat. Drop the circuit board gently into the etchant, taking care not to splash the solution. Copper side should be up. Move the board around from time to time during the etching process, using a plastic or glass rod or a pair of plastic tongs.



Fig. 60—Hot etching of printed-circuit board.

In general, as the temperature of the etchant is raised up to the boiling point, the speed of the etching action increases. If it is too hot, however, excessive water evaporation will take place, concentrating the solution and slowing the etching process. An ideal etching temperature is between 90° and 130° F. After considerable etching using the hot method, a little water can be added to the solution to replace the water lost through evaporation. An average circuit board can be etched with the hot method in about two to five minutes, depending on the condition of the etchant, the amount of exposed copper, and the actual etching temperature.

To etch the circuit board by the cold method, pour about ½ inch of etchant into the tray. Drop the board gently into the tray, copper side up. Rock the tray slightly during the etching process so that the etchant moves back and forth across the surface of the board. The average etching time is ten to twenty minutes.

Regardless of the method used, continue the etching process until all exposed copper is removed, leaving only the copper foil protected by the resist.

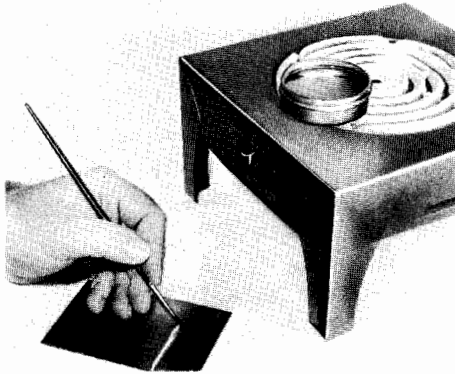

Fig. 61

After the etching has been completed, the etchant can be returned to a tightly sealed storage jar or bottle and the circuit board thoroughly rinsed under clear running water. Allow the board to dry.

After thorough rinsing and drying, the resist should be removed from the board, leaving the copper-foil “printed” circuit.

Ink resist can be removed by rubbing with steel wool, and a final cleaning can be made using a soft cloth dampened slightly with a general-purpose solvent such as General Cement No. 31-16 x. Tape resist is simply peeled off.

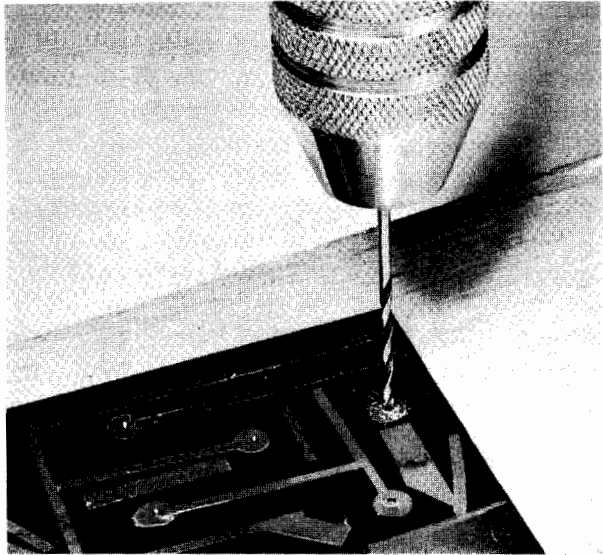

Fig. 62—Drilling component mounting holes in printed-circuit board.

Component mounting and eyelet mounting holes are then drilled in the etched board at the points required. Normally, a size No. 52 drill is used, but a slightly smaller or larger drill may be employed in some cases. Use a solid backing for the board during drilling to avoid cracking the phenolic. After the drilling has been completed, mount eyelets (brass or copper) in appropriate holes. Eyelets are usually mounted wherever connections are likely to be removed and replaced frequently. Where permanent connections are to be made, eyelets are not necessary.

Resistors, capacitors, coils, and similar components are mounted by passing their leads through appropriate holes in the etched circuit board. The customary practice is to mount these components on the back (nonetched) side of the board. When mounted in this position, lead tension tends to hold the foil in place instead of pulling it away from the base. Leave the component leads full length. After passing the leads through the holes and pressing the component tightly against the board, the leads are bent slightly to one side, holding the components in position through natural tension. Circuit crossovers, where necessary, can be made with short lengths of ordinary hookup wire that has been stripped at both ends.

When all leads have been soldered in place, projecting wires can be cut off close to the circuit board using a pair of diagonal cutters. As a final touch, the completed circuit can be given one or two coats of

silicone resin, either sprayed on from a pressure-type can or applied with a small brush. This insulates and protects the completed circuit and reduces the chances of arcing between adjacent conductors under conditions of high humidity. Either type of silicone resin is available from General Cement Company as Type 14-6 (spray) or Type 14-2 (liquid).

Cutting Corners

The most time-consuming steps in the preparation of an etched circuit are laying out the circuit and applying the resist. Here it is best to use simplified techniques to accomplish your objective.

You can acquire skill in designing circuit layouts by making up practice designs based on the schematic diagrams of various construction projects. It is not necessary to carry the circuit through to final etching and assembly to make this practice of value. You should learn to visualize a circuit in terms of two-dimensional wiring.

Once you have acquired skill in layout, you will find that you can eliminate the initial step entirely and design your layout as you apply the resist to the copper-clad board. Then you can simplify the latter step by using a type of resist that is easy to apply. However, be sure to clean the board before applying the resist.

The conventional resist, asphalt-based ink, is messy to use; it dries rapidly and becomes thick, making it difficult to apply. Tape resist, although cleaner to use, is tedious to apply; the tape must be burnished against the copper-clad board to ensure good adhesion. If care isn't taken here, the etchant will eat under the tape and ruin the circuit board.

Fortunately, there are other resists suitable for etched circuit work that do not have such disadvantages. Paraffin wax is a resist used for centuries in the acid etching of metals and glass.

There is a definite technique to applying a paraffin wax resist to a circuit board.

First, *melt* the wax in a small metal container. Make sure that all the wax is thoroughly melted (good-quality wax will look like water when liquid), but don't allow it to overheat or to smoke.

It is very important to preheat the copper-clad board. If the board is too cold, the applied wax will freeze on its surface. When the board is preheated, the wax will spread and flow over the surface.

The wax is applied to the board with a fine brush (see Fig. 62). Simply paint the pattern you wish directly on the board.

A paraffin wax resist is suitable for all types of etched circuit boards. However, you must use a cold etching process when you use a wax resist; hot etchant will melt the wax and ruin your circuit board.

Stripping

A simplified technique that will eliminate the etching process can be used where the circuit is not complicated. With a heavy-duty hobby knife, cut away the unnecessary copper foil. These pieces can then be stripped off by hand, leaving only the desired wiring pattern.

This method consists first of planning the layout on a piece of paper. Draw out the design, employing the actual components to be used to help provide physical dimensions. After the design is considered satisfactory, transfer it to a piece of $\frac{1}{16}$ -inch copper laminate by using a center punch or scribe. With a sharp model knife, cut the pattern into the copper, then peel off the unwanted portions.

Almost any circuit can be put on a printed-circuit card. Here is a step-by-step explanation of how to make a printed circuit, using a simple radio control receiver as an example. (The original circuit and the finished circuit board are shown in Fig. 63.)

Gather all the components called for in the circuit. Plan on making the copper lines wider than actually necessary— $\frac{3}{32}$ inch to $\frac{1}{8}$ inch should be ample. (Finer lines and extreme miniaturization may be attempted later.) So that the tube may be removed, use miniature tube sockets for subminiature tube leads. Use eyelets if the tube is to be soldered onto the base.

With the parts, paper, pencil, and rule, juggle the components around, using the schematic to determine where to place each part. Using many sheets of paper in this step of the process will produce a much neater unit.

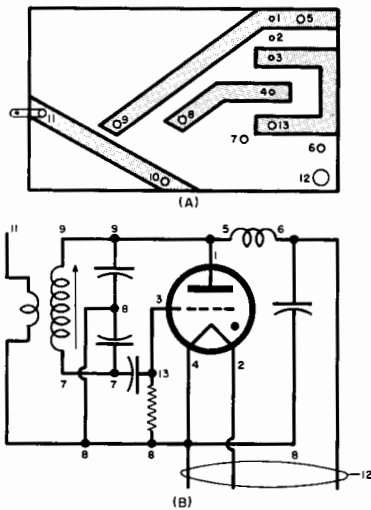

Fig. 63—Original radio control receiver circuit (top) and stripped circuit board (bottom). Numbers indicate corresponding points.

When the layout is satisfactory, double check to make sure the wires correspond to the schematic.

Cut the copper laminate to the size required for the base. With a center punch, scribe, or any sharp-pointed tool, transfer the paper pattern to the copper side of the laminate. Connect the lines and draw a pencil pattern of the strips desired. With a sharp model knife, cut these lines just heavily enough to penetrate the copper (see Fig. 64). Practice on some scraps will help you to determine the amount of pressure required.

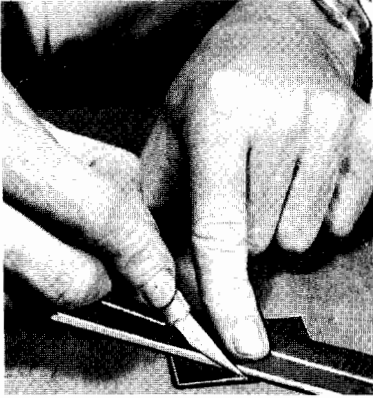

Fig. 64

After all lines have been scored, use the knife to cut between the copper and the base and slowly peel off the unwanted copper (see Fig. 65). Take this step slowly; too hasty a pull may yank loose some of the copper wanted for wiring.

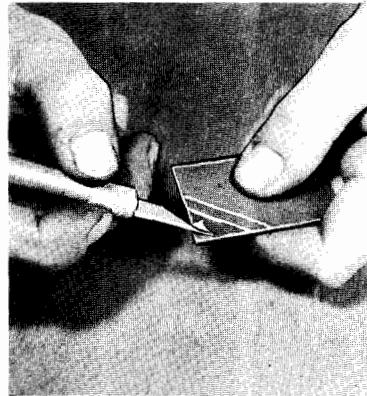

Fig. 65

After the card has been completely stripped, use steel wool to smooth off any rough edges on the lines (see Fig. 66). Drill the holes required by the layout, using a sharp drill.



Fig. 66

With a lightweight soldering iron, mount the components, then snip off the excess leads. If the layout is correct and all solder joints have been made properly, the set should be ready to go. That's all there is to it!

6 BUILDING A WORKSHOP

FOR THE true experimenter, the kitchen table may serve as an adequate workbench. He can put up with the moving of unfinished projects when dinnertime comes. He can also put up with the hunt for parts lost in the movement.

However, it is not necessary for the home experimenter to be without a place to work. Even in a small apartment, it is possible to set up a workshop that will provide the features necessary to make your hobby a pleasure instead of a burden to everyone else in the house.

The ideal workbench should have several features. Some are essential, others are desirable, some are luxuries. Here is a checklist for your own work area:

1. Good lighting
2. Sufficient bench space
3. Main tools and instruments within easy reach but out of the way when not needed
4. Storage space within easy reach for commonly used parts
5. Additional storage space for larger parts and parts used less frequently

If you have no space at all, a portable shop can be made that will fit into a closet when not in use. The man with a bit more room can build a shop that hangs on a wall, out of the way until needed. If the space is available, a permanent shop can be constructed at small cost.

None of the benches described below require any woodworking tools other than a screwdriver and a drill. If you take the parts list and diagram to your local lumberyard, you can have the pieces cut to size. All you will have to do will be to screw them together.

Apartment Workshop

The experimenter living in an apartment needs a bench that can be put out of the way when it is not being used, but that will provide sufficient "elbow room" for his work. The solution to this problem is a wall unit with a drop-leaf "door" (see Fig. 67). When the door is open, a Masonite work surface is revealed which can stand plenty of abuse from soldering irons and tools. The front of the door has a small $\frac{3}{4}$ -inch flange into which an aluminum leg is fitted for support. Test equipment can be stored on the bottom shelf.

The second shelf has enough room for twenty-four parts drawers in which to store resistors, capacitors, hardware, and miscellaneous items. The third shelf will hold copies of books, schematics, and catalogues.

At the top is an adjustable shelf that will be handy for storing larger tools and projects. The adjustment feature can be installed with commercially available shelf supports.

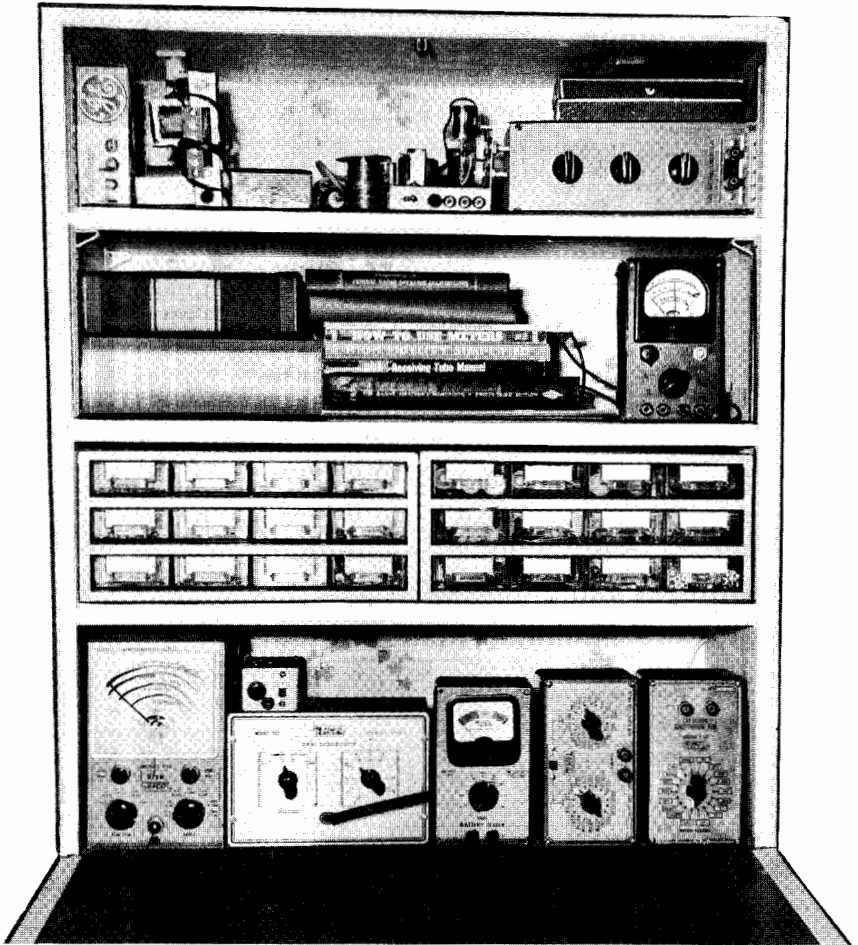

Fig. 67—This workbench folds against the wall when not in use. Storage space is adequate for essential equipment.

Comparatively simple to put together, the unit should take only three or four hours to construct. The entire cabinet is made of $\frac{3}{4}$ -inch by $9\frac{3}{4}$ -inch pine shelving* and is assembled with nails (8d or 10d size) and wood glue. The drop-leaf door is $\frac{3}{4}$ -inch plywood.

When the door is closed, it is held tight by a hook-and-eye catch. Brass hinges (2 inches by $\frac{1}{2}$ inch) are screwed to the front of the bottom shelf so that the door will close flush with the shelf. A $\frac{1}{8}$ -inch piece of tempered Masonite, glued to the back of the door, will serve as the work surface.

PARTS LIST

- 2- $31\frac{3}{4}$ " lengths of $\frac{3}{4}$ " X $9\frac{3}{4}$ " pine shelving (sides of cabinet)
- 5-25" lengths of $\frac{3}{4}$ " X $9\frac{3}{4}$ " pine shelving (top, bottom and shelves)
- 1- $26\frac{1}{2}$ " X $31\frac{3}{4}$ " section of $\frac{3}{4}$ " plywood (front)
- 1- $24\frac{1}{2}$ " X 30" section of $\frac{1}{8}$ " tempered Masonite
- Misc. hook and eye, wood screws, nails, 2" X $\frac{1}{2}$ " hinges, etc.

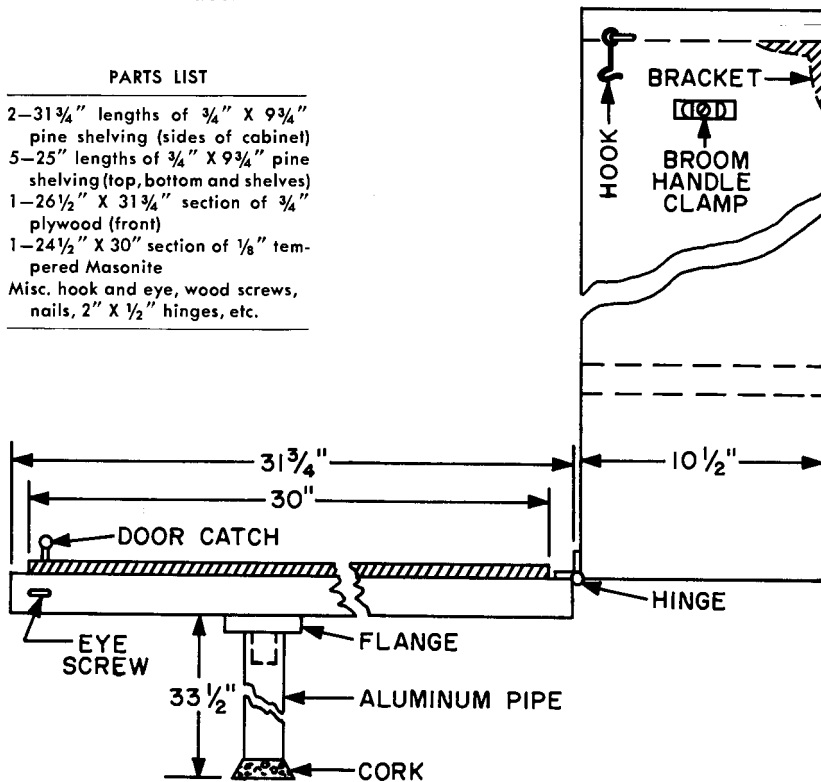

Fig. 68—Mechanical drawing of the "hidden" bench.

A $\frac{3}{4}$ -inch flange, into which an aluminum pipe can be inserted, can be mounted on the front panel. The pipe shown was cut from a discarded antenna mast and a cork was set in one end of it to prevent marring the floor. When not in use, the pipe can be stored on the side of the unit and held there by a broom-handle clip. You can determine the exact length of pipe needed after mounting the cabinet on the wall.

* This board is sold as 1-inch by 10-inch shelving at lumber yards.

The cabinet is held in place on the wall by means of brackets and rawl plugs and screws, Moly or toggle bolts. The type of fastener used will depend upon the type of kitchen wall you have. If in doubt, consult your landlord or superintendent.

As a finishing touch, the outside of the cabinet can be covered with wallpaper or painted to match the wall.

Full-size Workshop

The bench shown in Fig. 69 will provide plenty of working and storage space for the experimenter with a basement or workroom at his disposal. A wall cabinet provides space for instruments and tools, and an additional space under the bench provides storage for heavy chassis and the "junkbox" for used parts. The entire setup can be constructed from two 4-foot by 8-foot plywood panels and one 4-foot by 4-foot $\frac{1}{4}$ -inch panel. The legs and cross braces are cut from 2-inch by 4-inch boards. All of the panels are $\frac{3}{4}$ inch thick to ensure rigid construction.

Fig. 70 shows how the parts for the bench should be cut from the panels. Your local lumber dealer can do this cutting for you if you do not have the woodworking equipment. (Be sure to have the legs notched as indicated.)

After the parts have been cut from the plywood panels, sandpaper all the edges, using 1/0 sandpaper. To assemble the 2×4 lower shelf framing use screws and glue on each joint. Screws can be $1\frac{1}{2}$ -inch No. 8 flathead screws throughout the construction. Always pre-drill pilot



Fig. 69—Large workbench provides complete facilities for experimenter. Note large storage area beneath bench.

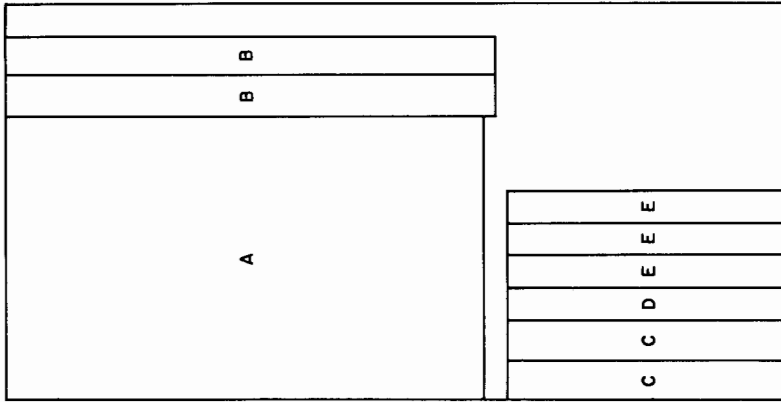

3/4" x 4'0" x 8'0" PLYPANEL A-D

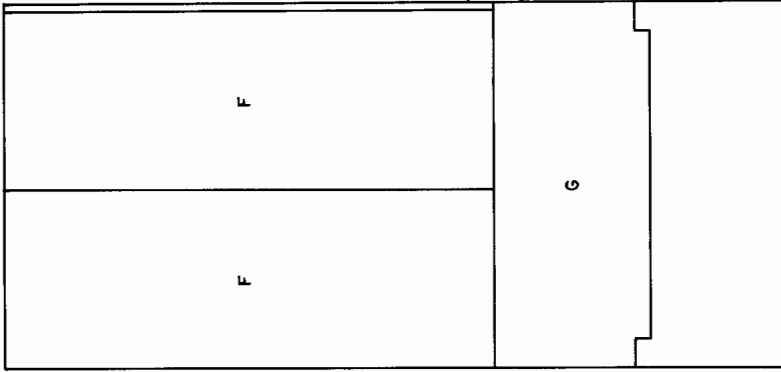

3/4" x 4'0" x 8'0" PLYPANEL A-D

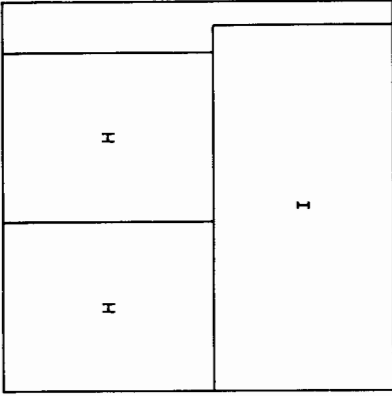

1/4" x 4'0" x 4'0" PLYPANEL A-D

PARTS LIST

Code	No. Req'd	Size	Part
A	1	34 1/2" X 58 1/2"	Tool cabinet back
B	2	4 3/4" X 60"	Tool cabinet top, bottom
C	2	4 3/4" X 34 1/2"	Tool cabinet sides
D	1	4" X 34 1/2"	Tool cabinet shelf standard
E	3	4" X 34 1/2"	Tool cabinet shelves
F	2	23 3/4" X 60"	Workbench top
G	1	19 3/8" X 48"	Workbench bottom shelf
H	2	21" X 25 7/8"	Workbench sides
I	1	22" X 44 3/4"	Workbench back

Misc.—6d and 8d finish nails
 8d common nails
 wood screws, hooks as required
 waterproof glue and finishing materials

Fig. 70—How plywood panels are cut to obtain required parts.

holes for screws. Fasten the $\frac{3}{4}$ -inch plywood shelf to this frame. Then set up legs, end cross braces, and the top rails. Screw and glue the $\frac{1}{4}$ -inch plywood back panel and end panel to the 2×4 's.

The top of the workbench is made from two $\frac{3}{4}$ -inch plywood panels glued together for rigidity. Coat one face of a panel with glue and place the other one on top of it. Install screws around the edges of the panels to hold them together. Place some screws around the center of the panels to hold that area in tight contact until the glue dries. Install all of these screws from the side of the double panel that will be the bottom side of the bench top. Round off the edges of the top and corners with sandpaper and fasten the top to the framework with glue and screws.

To assemble the tool cabinet, glue and screw the side and end

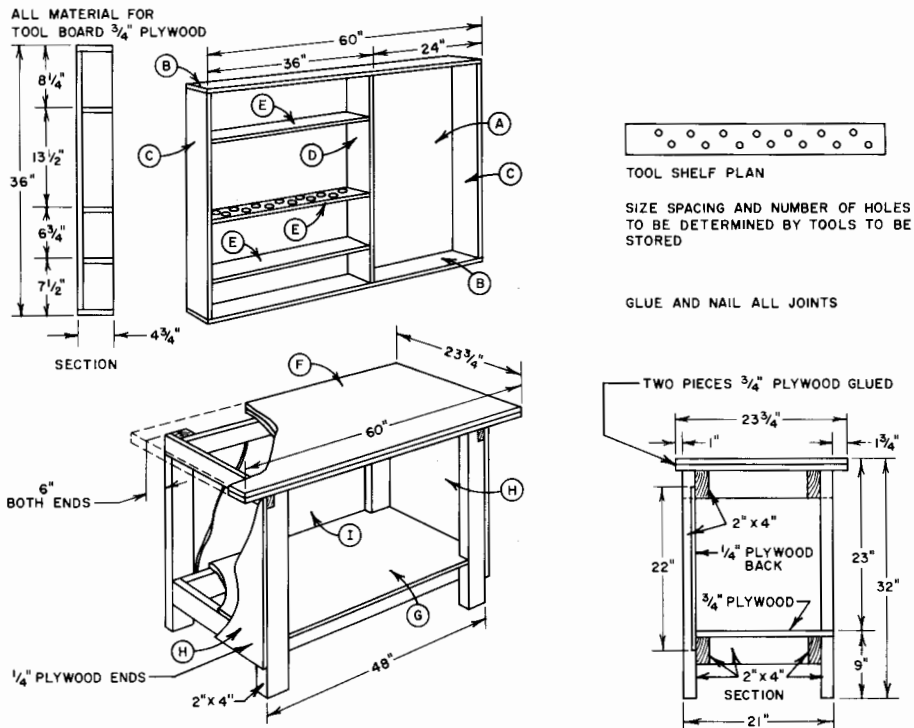

strips to the back panel. Bore holes for your tools in one shelf before installing the vertical divider and shelving. The shelves can be installed at any spacing that is suitable to your equipment. Typical spacings are given in the diagram.

Painting the understructure of the bench and tool cabinet gives worthwhile protection and makes cleaning easier. Rub it with 3/0 sandpaper, prime the wood with enamel undercoating or resin sealer, and apply two finishing coats of paint in the color you desire.

Workbench Tricks

There are a number of ways to make your workbench more convenient to use. If you use a soldering iron in preference to a soldering gun, you will find that a soldering stand which automatically controls the heat of your iron is a useful accessory. The stand, shown in Fig. 72, features a rocker arm rest which triggers a simple circuit to regulate the voltage supplied to the iron's heating element. For light soldering, there's enough heat in the tip at all times to do a good job. When high heat is required, the iron is ready for use about fifteen seconds after lifting it from the soldering stand.

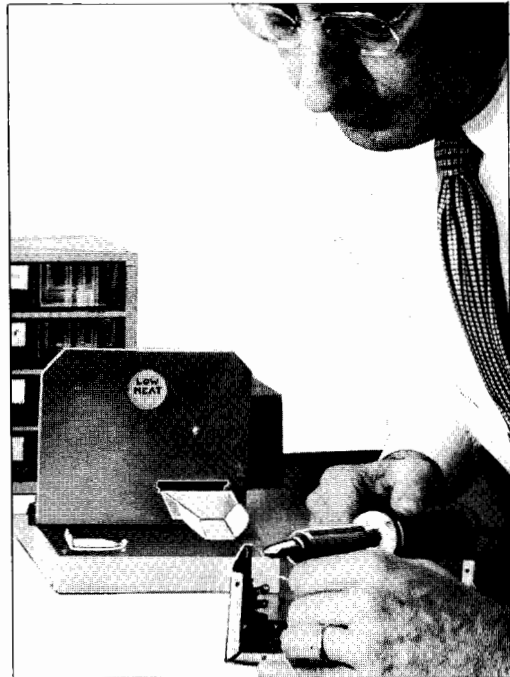

Fig. 72—Heat-controlled soldering stand keeps iron at low heat when not in use.

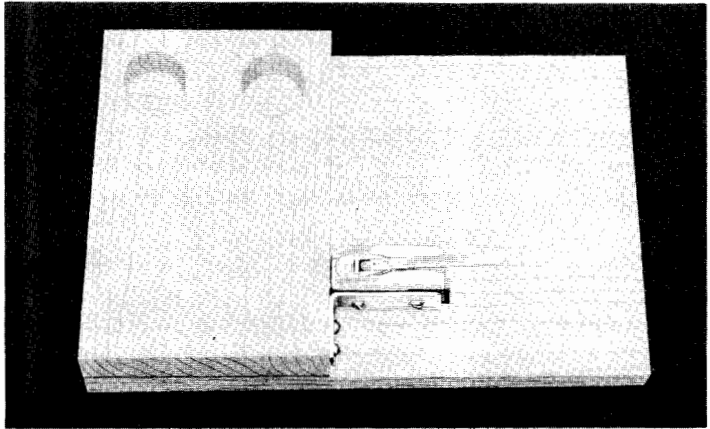

Fig. 73—Base block glued to main base. The two holes are $1\frac{1}{4}$ inches in diameter and must line up with holes in aluminum plate. Lever switch and bracket nestle in cutout made in main base and are secured in place with wood screws.

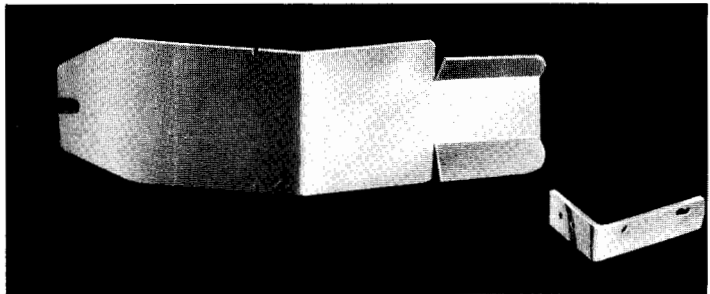

Fig. 74—Rocker fashioned from aluminum. Notches must fit snugly into narrower part of rocker cutout in aluminum mounting frame. The leaf spring is stainless steel strap and the switch bracket is aluminum.

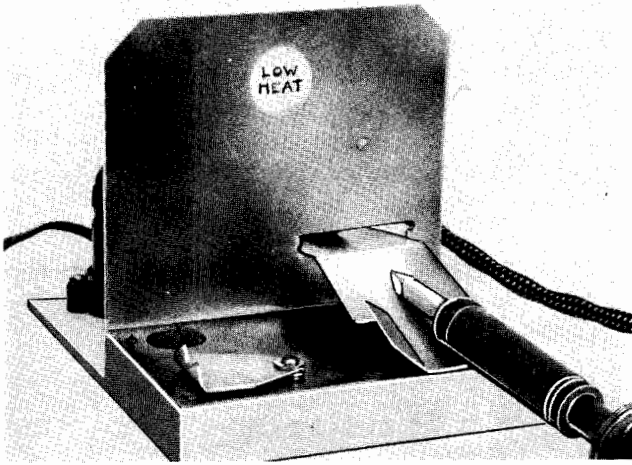

Fig. 75—Vertical section is aluminum; it is bent where it joins base block. Slit in lower right corner accommodates rocker-arm rest. Two circular holes must be punched in aluminum to match holes for cleaner and rosin cups in base block.

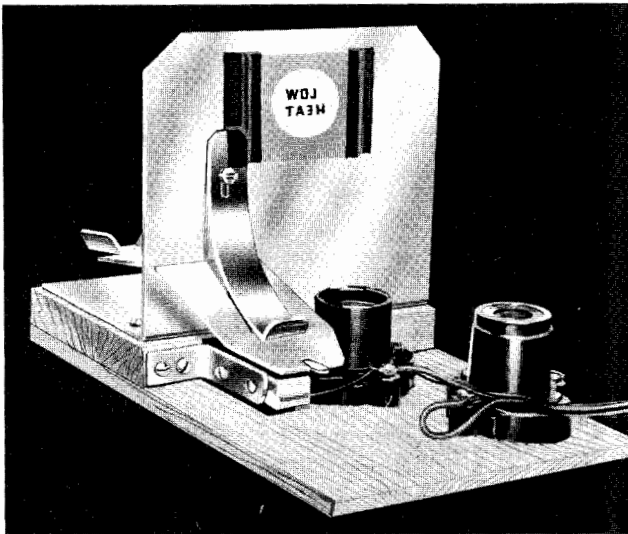

Fig. 76—Close-up of completed stand from opposite side. The socket in the foreground is used to plug in the iron, the other—near rocker—holds a 100-watt bulb.

A steel-wool cup on the stand provides a readily accessible place in which to brighten the faces of the iron. Insert the tip of the iron into the pad and rotate it once or twice. Another cup on the base of the stand contains rosin flux. The cover on this cup not only protects the flux when it is not being used, but it also serves as a high heat rest for the iron. This rest can be used when you want maximum heat from the iron during a heavy soldering job.

Construction of the stand is best seen in photos and captions. (Figs. 73-76). The parts list gives all of the required dimensions. The simple wiring for the heat control is given in Fig. 77.

PARTS LIST

PART	MATERIAL	LENGTH	WIDTH	THICKNESS
Plywood base	3-ply pine	9½"	6¼"	¼"
Base block	Pine	4¼"	6¼"	¾"
Mounting frame	Aluminum	9"	6¼"	18 gage
Rocker arm	Aluminum	7"	2"	14 gage
Leaf spring	Stainless steel TV antenna chimney strap	4½"	¾"
Lever switch mounting bracket	Aluminum	3"	½"	14 gage
Flux cover and high heat rest	Aluminum	2¾"	1½"	14 gage
Lever switch	Lever-arm spring switch, s.p.d.t., normally open type.			

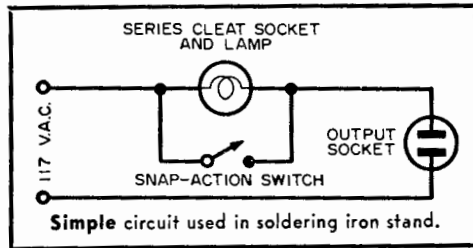
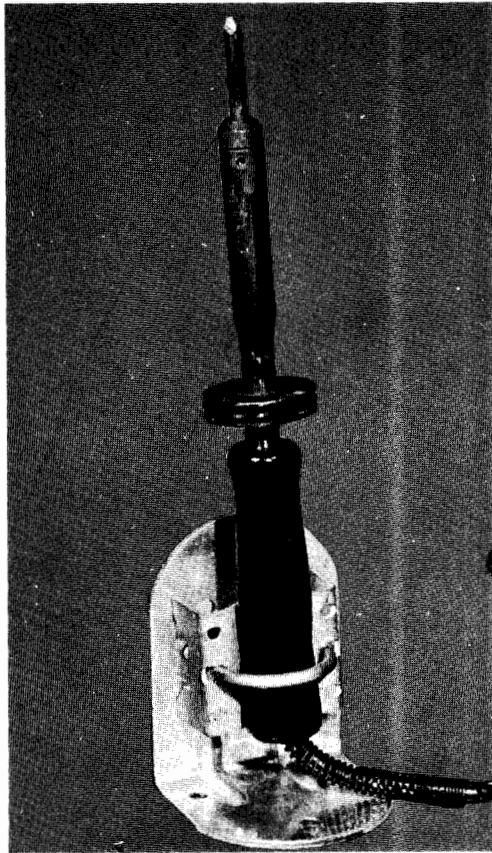

Fig. 77—Circuit for heat control unit.

A simple holder for your soldering iron can be made from a TV antenna mounting base (see Fig. 78). The base is about 4 inches high and 3 inches wide, with a clamp to fit the handle of the soldering iron.

For intermittent use the iron can be held with the base attached, and then the complete assembly can be set aside when the job is finished.

Fig. 78—A TV antenna mounting bracket used as a stand for soldering iron. Clamp can be tightened to attach it to the iron.



Parts storage is always a problem for the experimenter, but there are a few tricks that can be used to help solve the problem. Muffin tins borrowed from the kitchen make an excellent place to keep screws, nuts, solder lugs, and other small parts. Different size parts can be placed in the separate compartments where they will be easy to pick out and will stay sorted.

Ice-cube trays make an excellent storage place for small parts. These trays, made from either plastic or lightweight metal, make a suitable container for resistors, capacitors, washers, and miscellaneous hardware. The tray shown in Fig. 79 has twenty-eight small sections and will take up little space on the workbench. The individual compartments can be enlarged to fit bigger components by breaking off the dividing walls.

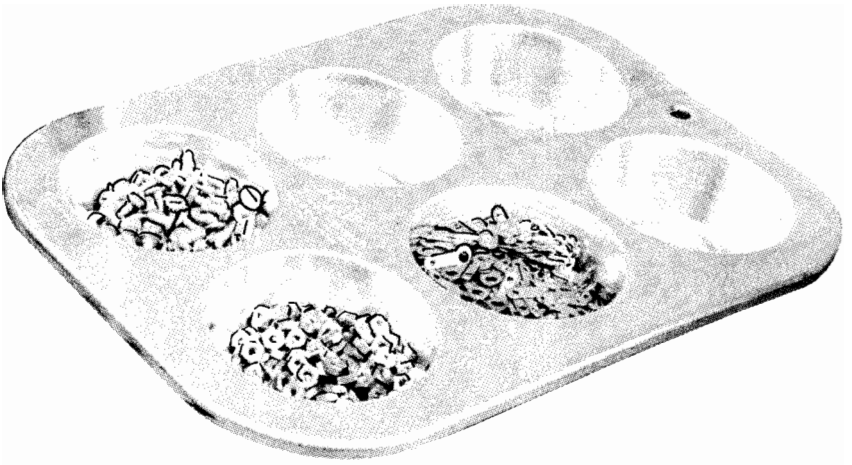

Fig. 79—A muffin tin and an ice cube tray are useful for parts storage.



Glass jars are ideal for more permanent storage of parts and hardware. However, you then run in to the problem of how and where to store the jars. Two solutions to this problem are presented here. Both are satisfactory, and your choice will depend on the space you have available. In the technique shown in Fig. 80, a board is cut to fit into an area on your workbench, with enough clearance behind to fit the jars you are using. The holes are cut just large enough to let the jars slope slightly backwards when inserted. The jars are supported at the back with strips of 1/2-inch by 1-inch molding, available at any lumberyard for a few cents a foot. The contents of each jar can be printed directly on the cover for easy identification.



Fig. 80—Rack for storage jars can be made from plywood panel, Masonite, or scrap wood.

Another way to use storage jars is shown in Fig. 81. The lid of the jar is installed on the underside of a shelf, using two small screws. The jars are then hung from the lids. The advantages of this system are that the contents of the jars are readily visible and that the jars take up no shelf space.

As you add to your collection of tools, you may find yourself short of rack space. Old typewriter ribbon spools can be used to add tool racks at minimum cost and effort. Nail the spools to the side of your bench or to a strip of wood as shown. Space the spools to hold the tools you have. The rack can be made to accommodate pliers, screwdrivers, nut drivers, files, and most other hand tools.

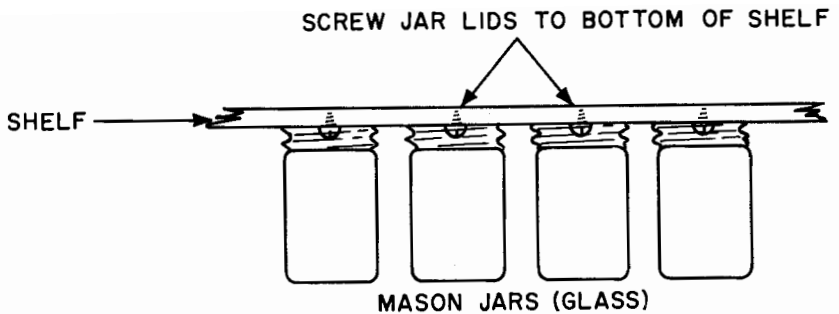

Fig. 81—Screwing jar top to underside of shelf makes a convenient jar storage rack.

A final suggestion for making your bench an easy place to work is to mount your voltmeter in a tilting rack for easy use. It is often difficult to get a head-on look at your meter dial. It is either too high or too low, or it's not facing you squarely. Under such conditions it is often impossible to get accurate readings. The rack shown in Fig. 82 solves this problem. With this rack, it is a simple matter to adjust the tilt of the meter face for easy reading. This mount can be simply constructed from wood scraps in less than an hour.

Dimensions are not given because they will depend on the size of your particular meter. However, be sure that the mount you build provides adjustment for tilting and has a large, heavy base for stability. There should be just enough room around the meter for easy removal of the instrument for use away from the shop.

In the unit shown in the photograph, a heavy oak base was used for weight and stability. The frame around the meter has a neat sliding fit. A narrow strip across the top back of the handle holds the meter in place and still permits easy removal.

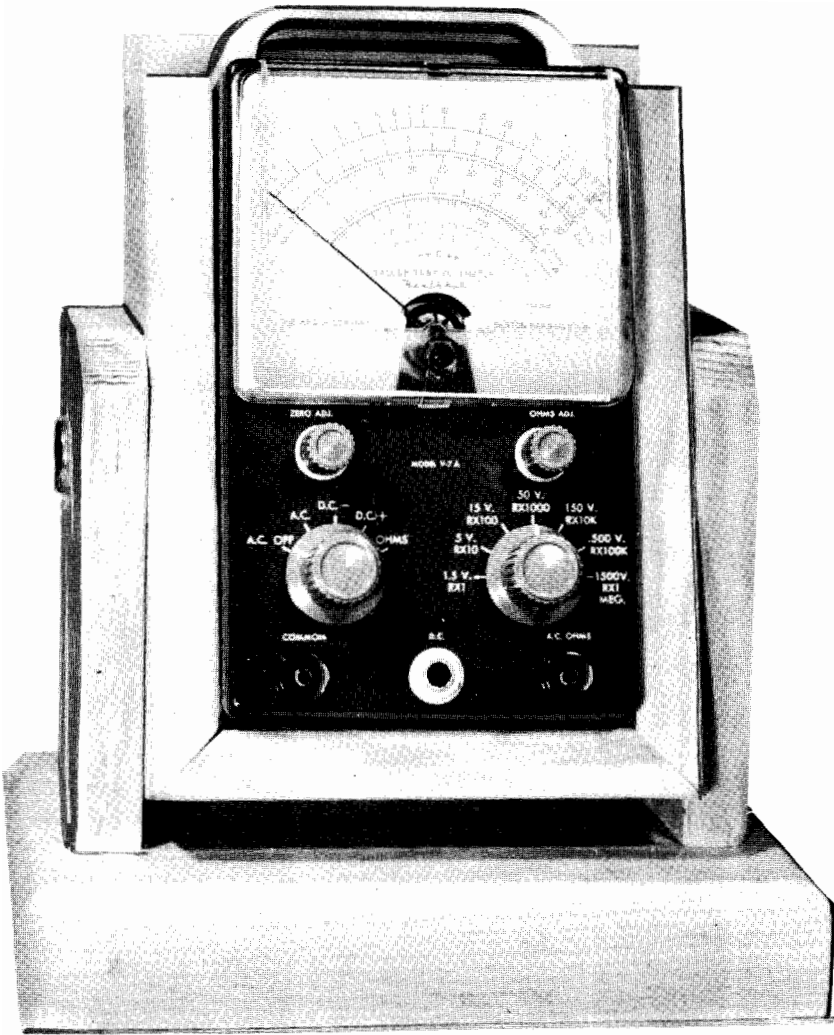

Fig. 82

7 SPECIAL TOOLS YOU CAN BUILD

Most of the tools used by the electronic experimenter are also used by other builders and craftsmen. However, a number of special tools can make the electronic worker's job easier and more fun. These tools include jigs that will let you work on both sides of a chassis without a lot of shifting and lifting and tools for cutting plastics and for winding coils so that they look professional.

Chassis Holders

A jig can be easily constructed to serve as a chassis holder suitable for the transistor-circuit builder and others who work with small circuits. It may be used to hold small chassis, miniature subassemblies, selector switches, terminal boards, coils, and other components in just the right position for wiring and testing. The total cost of construction should not be much more than a dollar. Almost all of the parts are available at the local hardware or dime store.

The complete unit is made up of two subassemblies—the base and the support arm, which includes the clamp and ball. The base is bent from a single piece of sheet metal which measures approximately 3 inches by 13 inches. Follow the general layout given in Fig. 83, but vary the size of the large holes to suit the ball used. Either steel or an aluminum alloy can be used for the base piece, but the metal chosen should be reasonably stiff and have a certain amount of springiness. Take special pains to ensure accuracy when bending the sides, so that the opposing holes line up perfectly. Smooth all holes and round off sharp edges with a file.

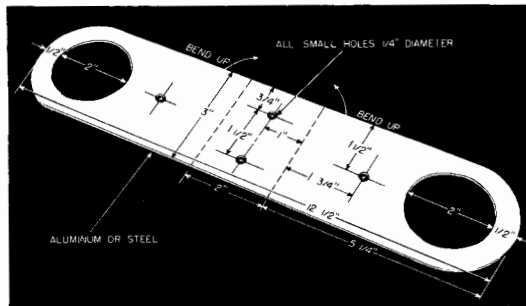

Fig. 83—Layout of the metal frame. The dimensions may be varied to suit the size of the clamp and solid rubber ball.

When the machine work and bending are finished, the base is completed by putting a 4-inch length of $\frac{1}{4}$ -inch diameter Redi-Bolt through the two opposing small holes, then fitting on a pair of flat washers and wing nuts. Do not tighten the wing nuts unless the ball is in place.

Use a solid rubber ball to make the ball joint. This is extremely important. Many of the small rubber balls offered for sale are hollow and fill with gas under pressure. Check this point before purchasing the ball.

Using a small piece of brass or steel tubing, bore a $\frac{1}{4}$ -inch hole through the ball. Sharpen the end of the tubing to give it a tapered end. Then, holding the ball in one hand and the tubing in the other, with a twisting motion force the tubing into the ball. After the tubing has cut part way into the ball, place the ball on a piece of scrap lumber or hardboard and bear down with weight to complete the boring job.

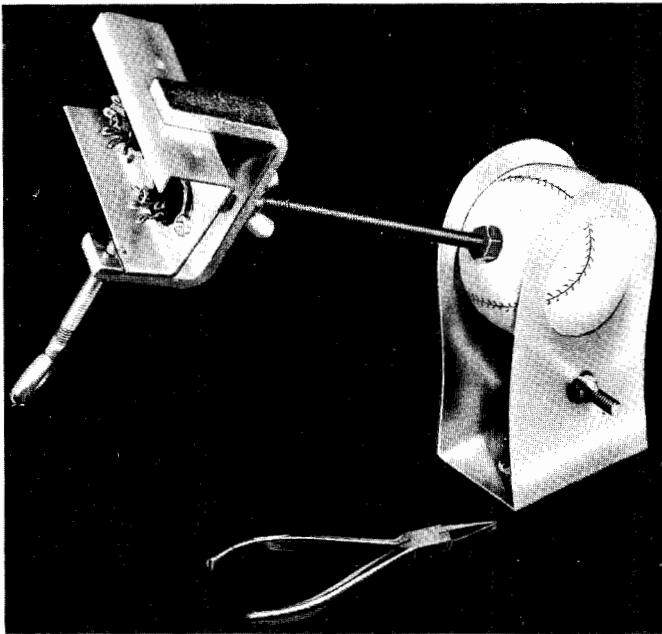

Fig. 84—Universal arm for small assemblies uses ball as movable joint.

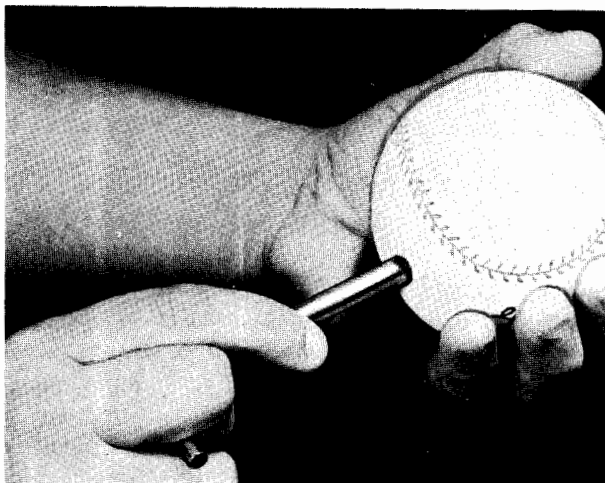

Fig. 85—To drill hole for the shaft in the rubber ball use a solid ball and "cork borer."

An 8-inch length of $\frac{1}{4}$ -inch Redi-Bolt, a rod stock that is available with threads already cut, serves as the support arm. Pass one end of the bolt through the hole previously bored in the rubber ball and fasten it with two flat washers and a pair of hex nuts, as shown in Fig. 86. Tighten the nuts enough to ensure a secure mounting, but don't use so much pressure that it distorts the ball.

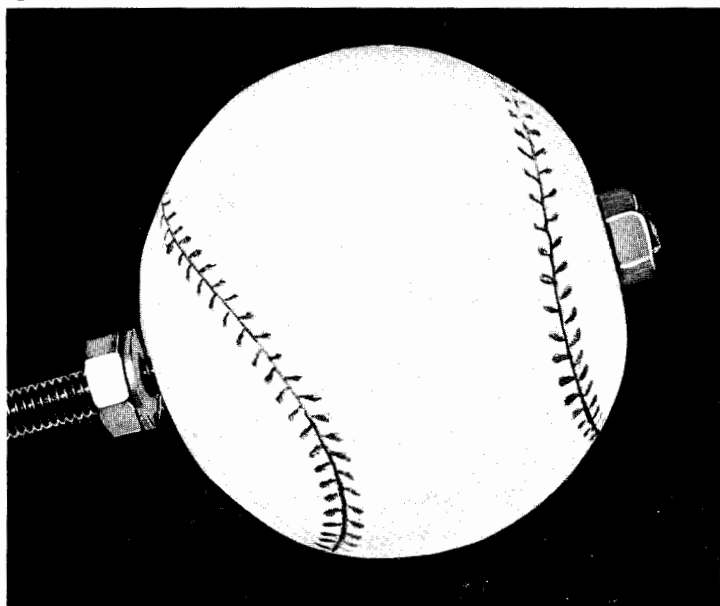

Fig. 86—Detail view of bolt mounted through the ball.

Next, mount a clamp at the opposite end of the support arm. Prepare the clamp by drilling a ¼-inch hole centered on the back strap. Attach it to the support arm using a hex nut, flat washer, and wing nut, as shown in Fig. 87. Lock the hex nut in place with cement. This will permit the clamp to rotate freely when the wing nut is loosened, without danger of the assembly falling apart.

Either mount the metal base permanently on the workbench or attach it to a large baseboard to be set on the bench when needed. If almost all your work is with subminiature assemblies, you will probably want a permanent mounting. On the other hand, if you work with full-size chassis on occasion, the temporary mounting will be better.

With the base mounted on the support arm subassembly, complete the job by mounting the support arm assembly in the base. Loosen the wing nuts on either side and force the rubber ball between the sides of the base until it snaps into place in the large holes. Then tighten the wing nuts.

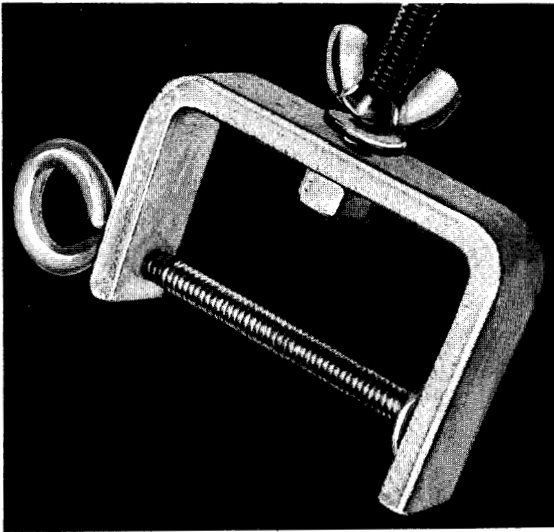

Fig. 87

The “Universal Arm” permits a miniature chassis or other small subassembly to be held in just the right position for wiring, assembling, and testing. When clamping a chassis to the arm, tighten the clamp sufficiently to ensure a snug grip, but don’t overtighten. Remember that the clamp is weakened somewhat by the hole in the back strap. If you are going to clamp polished metal parts in the arm, cement felt or rubber to the interior clamping edges of the clamp to avoid scratches.

Although the "Universal Arm" is strong enough to support miniature equipment and small subassemblies, it will not support heavy weights.

Whenever the "Universal Arm" will not be used for a period of time, loosen the base wing nuts, thus allowing the rubber ball to return to its original dimensions and permitting the rubber to "rest." If the ball is kept clamped in one position for a long period of time, a permanent "set" in the rubber may result.

When working with heavier chassis, a rack such as that shown in Fig. 88 will be more suitable. It is sturdy enough to support the heaviest chassis and can be built at low cost, from readily available parts, in two or three evenings or on a weekend.

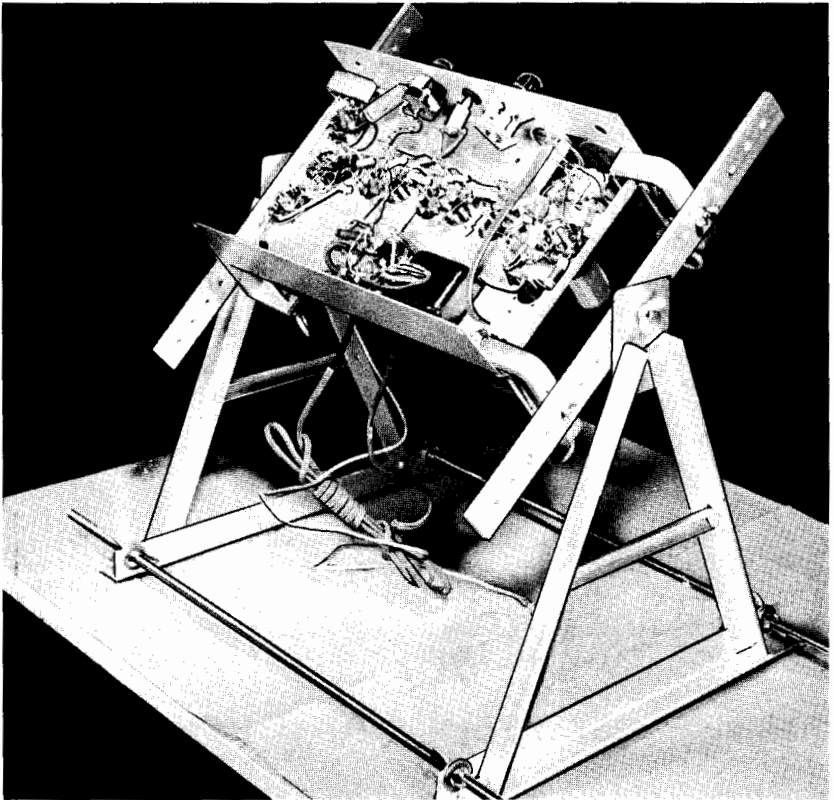

Fig. 88—Heavy-duty chassis rack is adjustable for a wide variety of chassis sizes.

The necessary parts are specified in the parts list. With the exception of the rubber feet, most of the material should be available at the local hardware store. The aluminum used is a special soft alloy that can be worked with ordinary woodworking tools—no need for special “high-speed” drill bits or saw blades.

The chassis rack consists of three subassemblies, the “A”-shaped end frames, the “rocker arms,” and the base. These can be fabricated individually, then assembled together to make the complete rack.

PARTS LIST

2—14" lengths of 1" X 1" X 1/16" aluminum angle stock*
4—12" lengths of 3/4" X 3/4" X 1/8" aluminum angle stock*
2—14" lengths of 1/4" X 1" aluminum bar stock*
2—6 1/2" lengths of 1/4" X 1/2" aluminum "U" channel stock*
1—2" X 6" piece of "half-hard" aluminum*
2—24" lengths of 5/16" Redi-Bolt stock
8—5/16" wing nuts to fit above Redi-Bolt stock
8—Flat washers with 5/16" hole
4—Stanley "Handy Clamps" (#CD 7097K)
4—3/16" X 24 X 3/4" long stove bolts
4—3/16" X 24 wing nuts
2—1/4" X 20 X 3/4" stove bolts
2—1/4" X 20 hex nuts
2—1/4" X 20 wing nuts
2—Flat washers with 1/4" hole
12—10-32 X 3/8" machine screws with binding heads
4—Rubber feet
4—#6 X 3/8" sheet metal screws

*Marketed by the Reynolds Aluminum Company as "Do-It-Yourself" aluminum

Two A-frames are needed. The parts required for assembling a single unit are shown in Fig. 89, and the completed A-frame is shown in Fig. 90. Cut and shape each part out of stock material, then drill all holes at the points indicated. Note that exact hole locations are not known in some cases. To locate these holes, assemble the cut-out pieces of stock material on the top of the workbench, then mark hole locations with a center punch. Perfect alignment of all parts, *before* final assembly, is possible when the A-frame has been loosely assembled in this fashion.

Tap the mounting holes in the side pieces for a 10-32 machine screw. When the drilling and tapping is completed, assemble each A-frame, using 3/8-inch-long 10-32 binding head machine screws—use Fig. 90 as a guide during assembly.

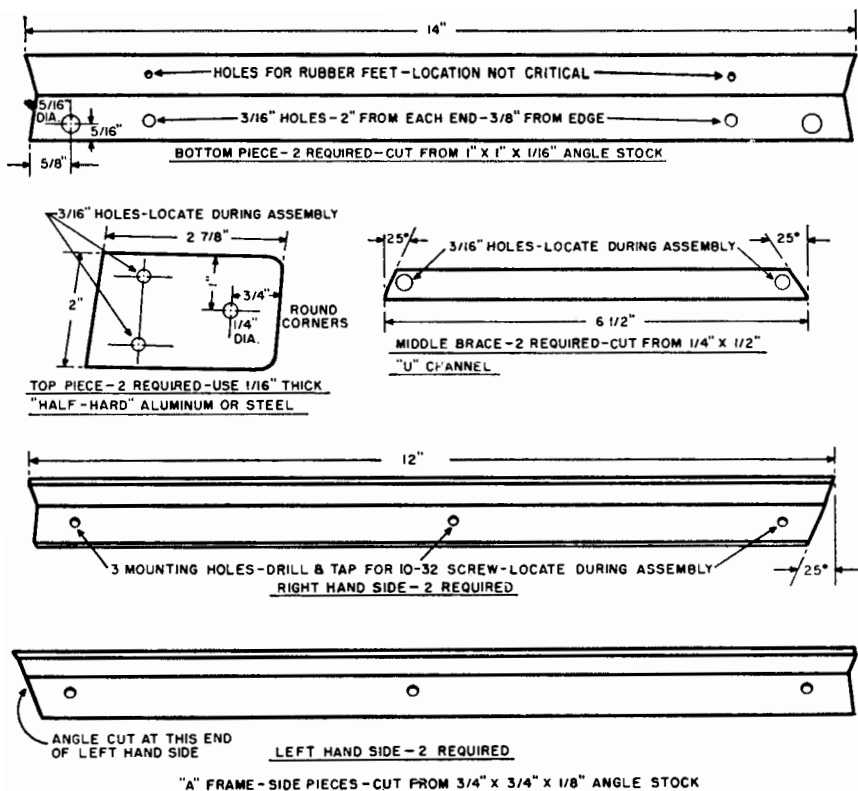

Fig. 89—Measurements of the pieces used to construct two A-frames.

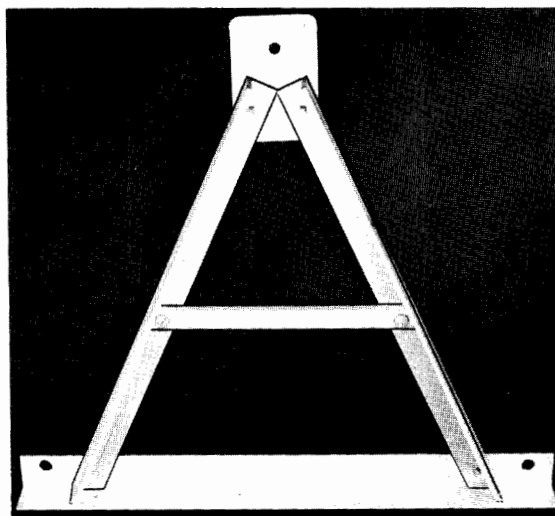

Fig. 90—Completely assembled A-frame.

The rocker arms act to support the chassis proper, and each consists of two clamps assembled on a heavy bar cut from $\frac{1}{4}$ -inch by 1-inch aluminum stock. Two bars are required. See Fig. 91 for the basic layout and necessary parts, and Fig. 92 for an assembled rocker arm. Prepare the clamps for mounting by drilling and tapping a hole for a $\frac{3}{16}$ -inch by 24-inch stove bolt, centered on the back strap of the clamp. Insert $\frac{3}{4}$ -inch-long $\frac{3}{16}$ -inch bolts from the inside, as shown in Fig. 93. Drill and tap a hole to accommodate a $\frac{1}{4}$ -inch stove bolt in the center of the rocker arm bar and insert a $\frac{3}{4}$ -inch-long $\frac{1}{4}$ -inch bolt. Place a $\frac{1}{4}$ -inch hex nut over this central bolt. This will hold the rocker arm away from the A-frame during final assembly.

The base consists of two 24-inch lengths of $\frac{5}{16}$ -inch Redi-Bolt, each equipped with a pair of wing nuts and flat washers at each end.

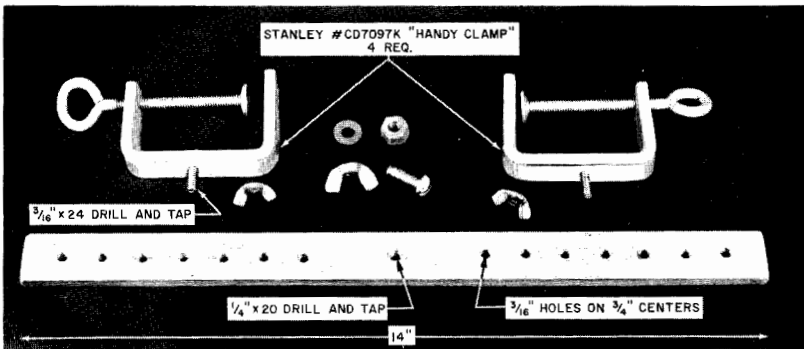

Fig. 91—Parts layout for rocker arm assembly of chassis rack.

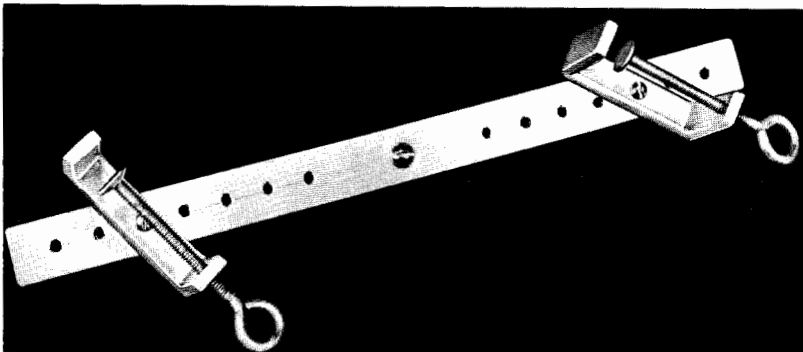

Fig. 92—Assembled rocker arm with clamps. Two of these arms are required.

Assemble A-frames to the Redi-Bolt base piece, using wing nuts and flat washers, as shown in Fig. 94. A flat washer placed on each side of the bottom angle piece of the A-frame will increase the clamping area of the wing nuts and ensure a stronger connection. The flat washers also reduce scratches in the soft aluminum alloy as the wing nuts are tightened and released. The A-frame can be moved by loosening the wing nuts and setting them in a new position, determined by the width or length of chassis that is held in the cradle.

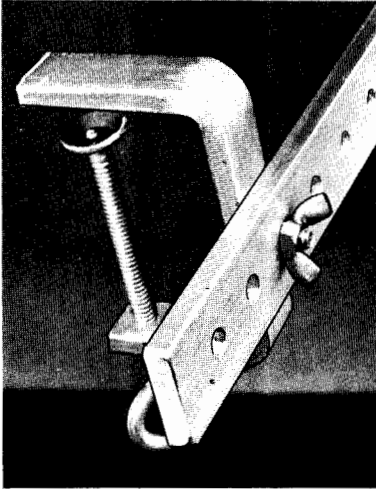

Fig. 93—Detail view of the mounting for one of the "Handy Clamps," which are manufactured by Stanley and are available from most hardware stores. To compensate for varying chassis weights, the clamps may be moved along the rocker bar to new pre-drilled positions.

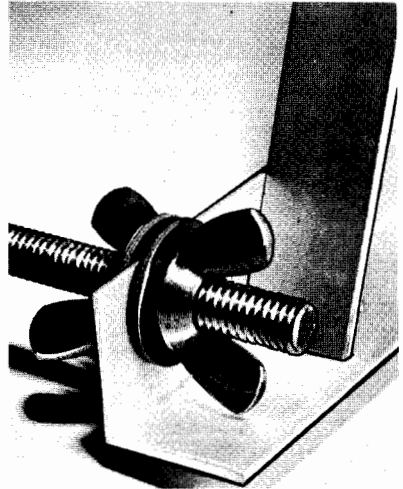

Fig. 94—A-frame and base assembly.

With the clamps mounted on the rocker arm bars (use small wing nuts here), assemble the complete rocker arm to the top piece of the A-frame, employing a $\frac{1}{4}$ -inch wing nut and a flat washer. The completely assembled chassis rack is shown in Fig. 95. "Handy clamps" on the rocker arms hold the chassis, which may be swung around to permit working on either the top or the bottom. Vary the position of the A-frame on Redi-Bolts to fit different lengths and/or widths. If desired, rubber feet can be mounted on the bottom angle pieces of the A-frames, but their use is optional.

The chassis rack can be adjusted for both the width and the length of the chassis to be mounted. Adjust for width by moving the clamps to different positions along the rocker-arm bar. Adjust for

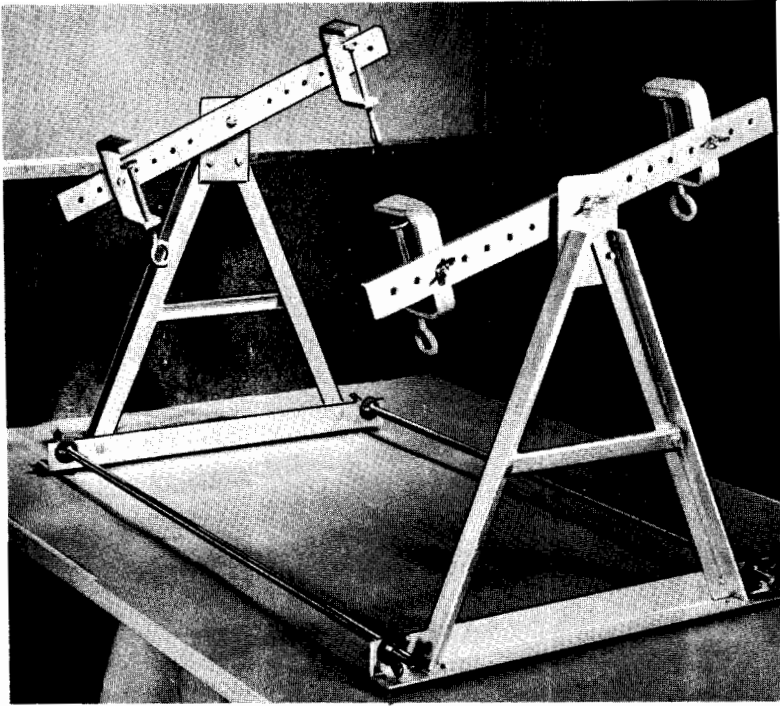

Fig. 95—Fully assembled chassis rack.

length by moving the A-frames along the Redi-Bolt base. Leave one A-frame in a fixed position on the base and move the other A-frame back and forth by adjusting the base wing nuts, or move both A-frames together so that the rack remains more-or-less centered on its Redi-Bolt base. (Make sure to move both sides of each A-frame the same distance—otherwise the frame may be mounted at a slight angle, thus placing the entire rack under a strain.)

Place the chassis in position between the clamps and mount it firmly by tightening these clamps. Once mounted, the chassis can be tilted to the desired working position by loosening the wing nuts holding the rocker arms to the top of the A-frame assemblies.

As shown and described, the chassis rack is designed to accommodate a wide variety of chassis sizes. For work with a chassis of a single length, the A-frames can be screwed down to a fixed wooden base plate.

Rocker arms can be lengthened or shortened to meet individual requirements and, if preferred, the series of mounting holes can be replaced with a continuous $\frac{3}{16}$ -inch slot. The clamps specified in the parts list can be replaced with either larger or small C-clamps.

Plastic Cutter

Many electronic projects require the use of a plastic sheet material, either as a subchassis in high-voltage circuits or as a cabinet construction material for projects. Plastic sheet is also widely used in making long pointer knobs, terminal panels, and labels for controls.

Most experimenters who attempt to work with plastic sheets experience difficulty in cutting the plastic to shape. This is particularly true of thicknesses of $\frac{1}{16}$ inch or less. Using a hot-wire cutter is the easiest way to form thin plastic sheets. The one described here is built from scrap wood, scrap aluminum, and very inexpensive electrical parts. It produces a fully finished edge that requires no further sanding or filing and will cut at any angle with the precision of a jigsaw.

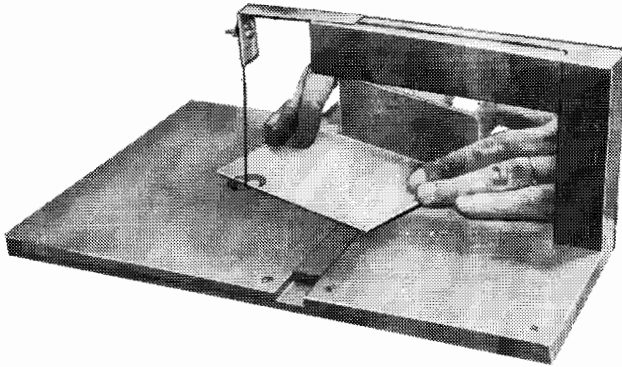

Fig. 96—How to use the completed plastic cutter to make right angles on $\frac{1}{16}$ -inch Lucite.

The base of the cutter is formed from three pieces of $\frac{1}{4}$ -inch pine or birch plywood. The largest piece forms the lower section of the base; the two upper pieces are carefully spaced to take the slide rod of a miter guide in a tight, but smooth, sliding fit. The spacing between the two upper sections is $\frac{3}{4}$ inch for smaller miter guides. These sections are screwed to the lower plywood layer.

Place the three base pieces in the exact position they will occupy in the finished product and mark them for the wire feed-through holes. These holes are centered on the base with respect to the long edges and are located about $4\frac{3}{4}$ inches from one short edge. Drill the upper base layer with a $1\frac{1}{8}$ -inch wood bit or expansion bit; this opening permits a 1-inch diameter disc of thin aluminum (with a needle-thick hole in the exact center) to fit below the surface of the top plywood board and rest on the bottom layer. Immediately below the $1\frac{1}{8}$ -inch hole, drill a $\frac{1}{4}$ -inch hole in the lower portion of the base concentrically with the one above.

PARTS LIST

1—10" X 15" X 1/4" piece of plywood (lower base)
1—6 1/8" X 10" X 1/4" piece of plywood (upper base)
1—8 7/8" X 10" X 1/4" piece of plywood (upper base)
1—8 3/8" X 1 1/4" X 1 1/4" piece of plywood (upright)
1—7 3/4" X 1 1/4" X 1 1/4" piece of plywood (cross-arm)
4—3 1/2" X 1 1/4" X 1 1/4" piece of plywood (legs)
PL1—Pilot light assembly
S1—S.p.s.t. toggle switch
T1—Filament transformer, 117-volt step-down to 6.3 volts, 6 amperes
1—5" length of #28 Nichrome wire

After the base has been assembled, cut a square indentation in the center of the edge opposite the feed-through holes. This will accept a 1 1/4-inch by 1 1/4-inch upright which forms the rising member of the support arm.

A mortised and glued joint between the crossarm and upright will repay the user in sturdiness. Before assembling the crossarm, cut a piece of 18-gage aluminum 3/4 inch wide and 4 3/4 inches long. Bend 1 1/4 inches of the aluminum bar down at right angles, hold the crossbar in place with the aluminum strip on top of it, and sight straight down along the bent flat. The object is to position the aluminum strip so that its short flat is directly above the wire feed-through hole. Drill the center of the short flat to clean an 8-32 machine screw before you screw the aluminum support to the crossarm.

Next, cut and glue the legs to the underside of the base at the corners and secure the crossarm to the bottom of the base by means of a 3-inch steel angle.

As a last step in the mechanical construction, mount a front apron for the cutter. Drill two 1/2-inch holes to receive the switch and the pilot light assembly; then screw the apron to the front legs.

Connect a 6.3-volt, 6-ampere filament transformer according to the diagram. Note that the pilot lamp is connected across the entire 6.3-volt secondary while only half of this winding supplies the current for heating the cutting wire.

A 4-inch length of No. 28 Nichrome wire provides the best cutting of thin polystyrene. This wire has a nominal resistance of a little over 4 ohms per foot, so that a 4-inch length draws about 4.5 amperes at 6 volts—well within the rating of the transformer. Cut a 5-inch length of the wire, knot one end, and pass the other end upward through the feed-through hole in the aluminum disc. Grasp the upper end of the

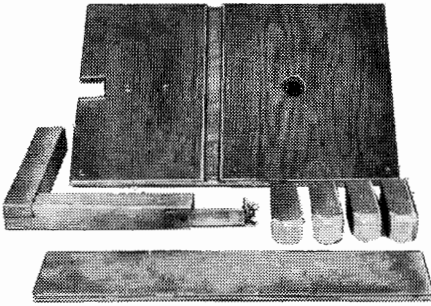

Fig. 97—Disassembled view. Note position of feedthrough holes with respect to miter guide groove.

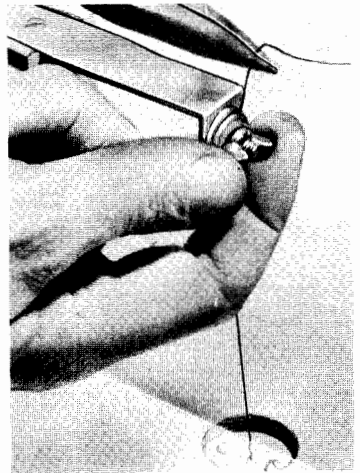

Fig. 98—Installation of Nichrome cutting wire.

wire with the tip of a pair of long-nose pliers, pass the wire around the bolt on the aluminum strip, and then tighten while holding the wire taut and the strip pulled down slightly. The strip will exert spring tension on the cutting wire and keep it from slackening.

Plug the line cord into a 117-volt a.c. outlet and turn the switch on. The Nichrome wire should become hot to the touch. The correct operating temperature is obtained when the wire is too hot to permit sustained finger contact, but not enough to show even a dull red glow. If the temperature of the wire is too low, the cutting process will consume too much time; if it is too high, the cut sections will have an unsightly bead along the edges. Improper heating indicates incorrect wire size or dimensioning.

Plastic sheeting that is to be cut should always be scribed lightly along the cleavage line by a sharp-pointed tool. Use your miter guide to cut straight lines at any angles (curved shapes, of course, are manipulated along the scribed line free hand).

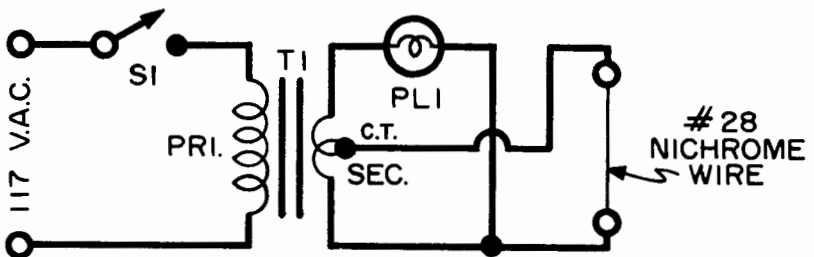

Fig. 99—Simple electrical circuit for plastic cutter heats No. 28 Nichrome wire.

Exert very light forward pressure on the material as the hot wire passes through it. When the traversal is finished, the two cut pieces will not automatically come apart because some remelting (called *regelation*) has occurred. Slight hand pressure on each side of the joint will always result in a clean break along the cleavage line, if reasonable care is exercised.

Coil Winder

Winding coils is often a tedious part of the experimenter's job. When a large number of turns are required, it is difficult to get them even and close together without overlapping them. The coil winding jig shown in Fig. 100 will not only give you a professional-looking coil, but will turn out units that perform as well as factory-made coils.



Fig. 100—Over-all view of the home-built coil-winding jig in operation. A "guide-paddle" is used to ensure level winding and professional appearance.

The complete jig may be assembled in only a few hours. Without working too fast, you should be able to assemble the jig and wind several coils in a single evening.

The base assembly shown in Fig. 101 is made up of two pieces of 1-inch by 2-inch stock and a small rectangular piece of ¼-inch hardboard (such as Masonite). Dimensions are not critical and you may use the measurements given in the parts list simply as a guide. Plywood may be substituted for the hardboard.

PARTS LIST

-
- 1—Piece of hard aluminum or steel sheet (see text) measuring approximately 13" X 3"
 - 1—Solid rubber ball about 3" in diameter.
 - 1—REDI-BOLT, ¼" X 20, about 12" long.
 - 1—"Handy Clamp" made by Stanley (#CD-7097K).
 - 3—Hex nuts, ¼" X 20.
 - 3—Wing nuts, ¼" X 20.
 - 5—Flat washers, ¼" hole.
-

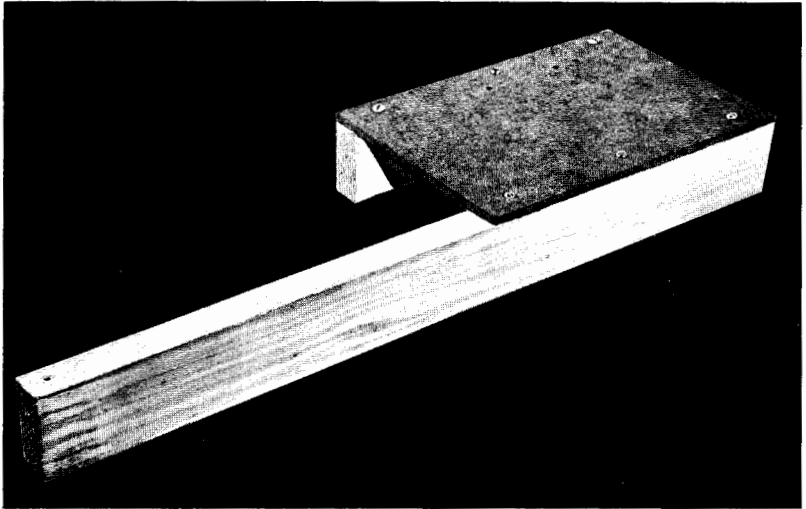

Fig. 101—Base assembly of coil winder.

Although standard round-head wood screws are used to hold the base assembly together in the model, you may prefer glue and nails, stove bolts, or other fasteners.

The illustrated model was left unfinished, but if you are handy with a brush you may wish to stain or enamel the wooden parts of the coil winder. If you do, paint the base assembly before assembling the jig.

The winding mechanism is made from an "egg-beater" type hand drill. Remove the handle and drill two mounting holes in the metal

shank. On most of these small drills, the handle is simply forced into place over the shank. The handle can be removed by clamping the drill in a vise (taking care not to damage the mechanism) and driving it off with a solid punch and hammer.

Another short piece of 1-inch by 2-inch stock is used for mounting the drill mechanism in place on the base assembly (see Fig. 102). Use long stove bolts which extend through the drill shank, the 1-inch by 2-inch block, and the hardboard. Use large flat washers under the nuts. Drive one or two wood screws from underneath through the hardboard into the 1-inch by 2-inch wooden block for additional strength.

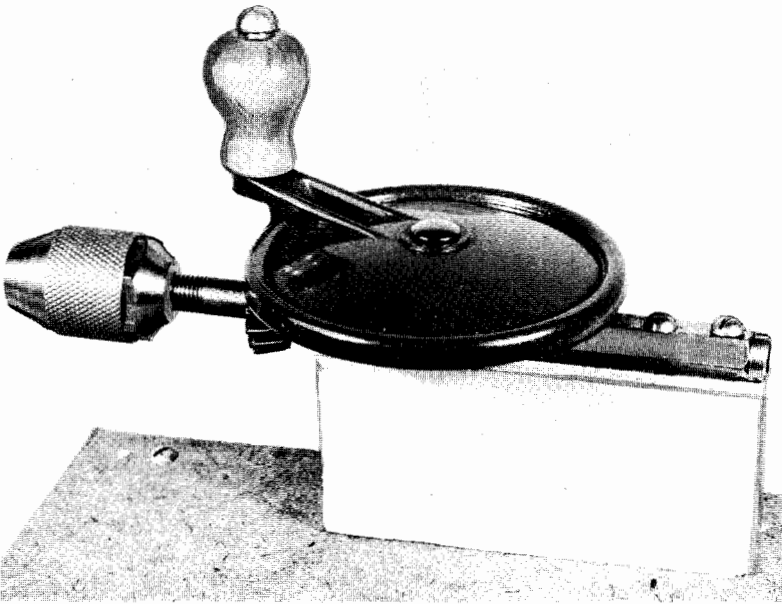

Fig. 102—Drill mechanism mounted on the base.

The wire rack is made up of two pieces of 1-inch by 1-inch extruded aluminum angle stock and a 12-inch length of $\frac{3}{8}$ -inch-diameter bar rod. The $\frac{3}{8}$ -inch rod can be aluminum, brass, steel, or plain wood doweling. Drill or punch a $\frac{3}{8}$ -inch hole near the ends of the angle stock to accept the rod. Take care to ensure a good snug fit. A strip of $\frac{1}{16}$ -inch-thick aluminum sheet is used as a "guide paddle" when winding coils, but it should not be assembled as part of the coil winder itself. After drilling and forming the angle stock, attach these two pieces to the base assembly with small wood screws, as shown in Fig. 103.

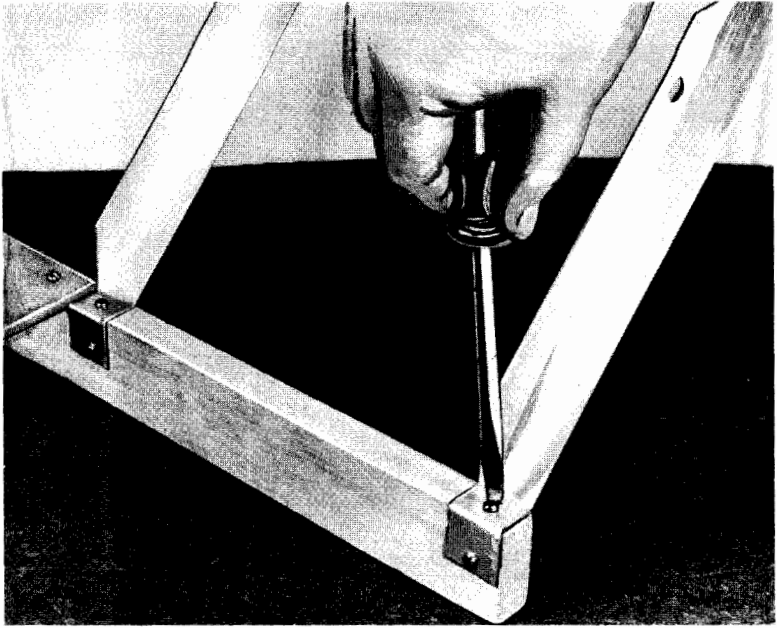

Fig. 103

The only remaining part of the coil winder is the form holder (see Fig. 104). This assembly is used to hold the coil form in place when winding coils. It is made up of a $\frac{1}{4}$ -inch-long threaded rod stock, two flat washers, a hex nut, a wing nut, and two cone-shaped wooden rods. The cone-shaped rods may be turned in a lathe from 1-inch dowel rod or whittled by hand from either dowel or a large thread spool.

After assembly, the form holder is clamped in the chuck of the drill mechanism with the hex nut nearest the drill.

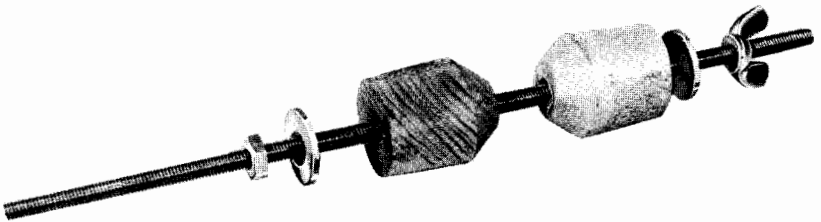

Fig. 104

Although the coil winder is quite easy to use, proper technique is essential to achieve smooth operation and to obtain the best results.

Follow the basic steps outlined below when winding coils, until you become familiar with the operation of the jig. You can then take "shortcuts" to speed up your work.

1. Select a spool of the proper type and gage wire for the coil you wish to wind and place it on the wire rack. If you don't have the wire in a regular spool, but in a hank, wind it on an old adhesive-tape spool.

2. Drill or punch a small hole in the "guide paddle" slightly larger than the wire diameter. De-burr the edges of the hole to obtain a smooth, rounded edge which will not nick the wire.

3. Clamp the coil form on the holder between the two wooden cones. Tighten the wing nut to ensure a snug fit.

4. Thread the wire through the hole in the "guide paddle" and attach the free end at the proper point on the coil form. Use a drop of cement or a small piece of Scotch tape.

5. Hold the "guide paddle" in one hand with your thumb against the wire and rotate the drill handle with your other hand (see Fig. 100). The guide paddle serves two purposes. First, with your thumb in place over the wire you can vary tension as necessary to ensure a smooth, tight winding. Second, you can guide the wire along the form to obtain either a close- or a wide-spaced winding.

6. When the coil is completed, keep tension on the wire (using the guide paddle) until you can fasten the end of the coil. Again, you may use a drop of cement or a piece of Scotch tape.

Any one of several methods may be used to keep track of the number of turns placed on the coil. If the coil is to have fifty turns or less, you can simply keep a mental record as you wind the coil.

Another method is to determine the number of turns of the coil form holder obtained with one full rotation of the drill mechanism handle, and then to rotate the drill handle enough times to give the coil desired. In the model, a single rotation of the drill handle gives three and one-third revolutions of the coil form, thus a 110-turn coil may be obtained by rotating the handle thirty-three times.

Still another method is to refer to the wire-size table and to determine the number of turns per linear inch obtained with the type and size wire you are using. The coil form is then marked off to indicate the length of winding, and wire is wound on the form until the marked space is completely filled. For example, No. 26 wire (B. & S. gage) with enamel insulation gives approximately fifty-eight turns per inch. A winding 2 inches long would contain 116 turns. This method is best used with close-spaced coils, but may be used, in modified form, where the spacing is equal to multiples of the diameter of the wire.

Permanent Breadboard

The experimenter who enjoys working with new circuits or likes to do his own development work will find that a permanent "breadboard" chassis will make his job easier. He can quickly set up and modify almost any circuit he desires with this chassis.

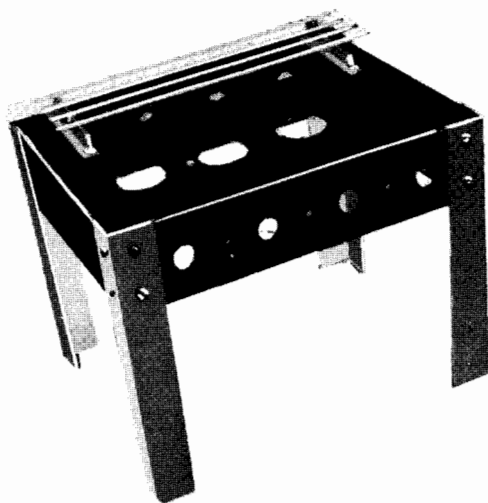

Fig. 105—The versatile "breadboard" chassis.

The chassis itself is drilled and punched from a standard 7-inch by 9-inch by 2-inch chassis base which is available from most parts distributors. The drilling layout for the top of the chassis and end and side layouts are shown in Fig. 106. Both ends and both sides are identical. Drill the small holes and use Greenlee or Pioneer punches for making the large holes.

Four leg brackets are needed. These are made from 1-inch by 1-inch by $\frac{1}{8}$ -inch thick extruded aluminum angle.

Socket holes in the main chassis are for standard octal sockets. If you work with miniature tubes, you will need adaptor plates for 7-pin and 9-pin miniature sockets. Dimensions for these adaptors are included in the mechanical diagram. Make as many as you think you'll need.

Any number of small accessory brackets can be made, depending on your individual requirements. Typical dimensions for a volume control bracket are given. You may wish to make brackets either larger or smaller or to make special brackets for particular jobs.

Mount the four leg brackets on the chassis, using $\frac{3}{8}$ -inch No. 6 sheet metal screws. Mount the two terminal strips and four ground

lugs with similar screws. Run four or more straight pieces of No. 12 tinned bus bar between corresponding positions on the terminal strips, soldering at both ends. When finished, the completed breadboard chassis should look like the one shown in Fig. 105.

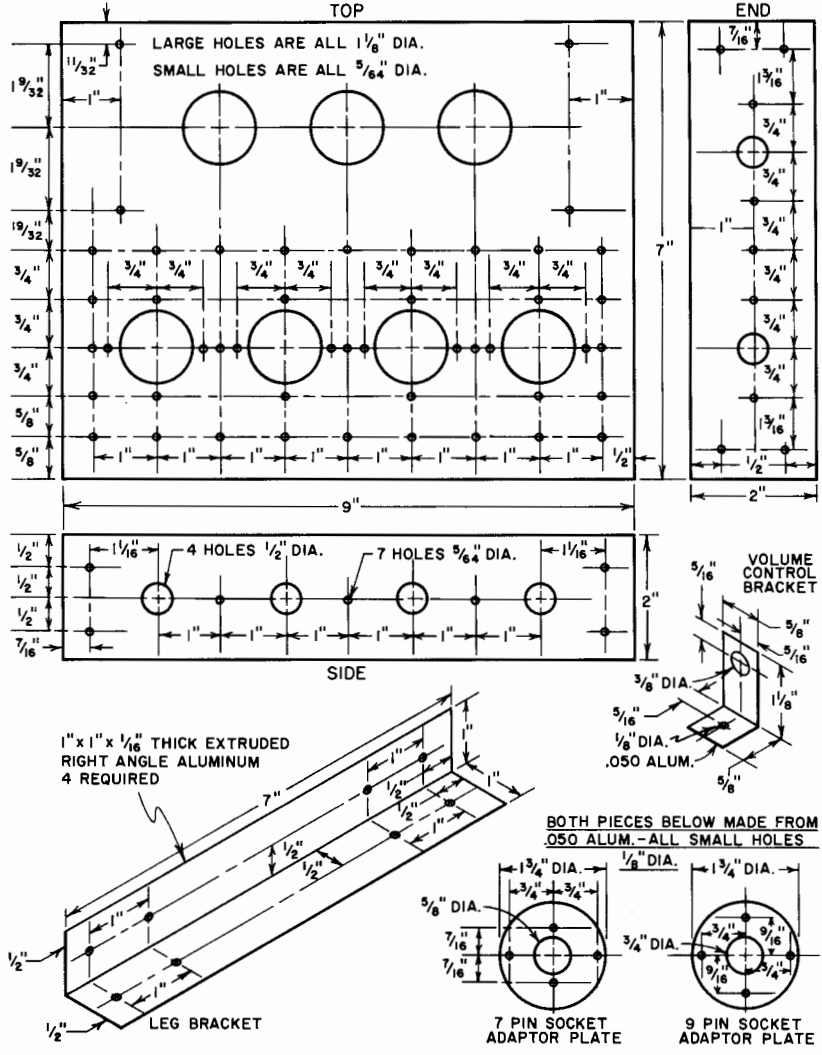

Fig. 106—Plans for assembly of permanent breadboard.

PARTS LIST

3 ft. 1" X 2" stock lumber
1 pc. 1/4" Masonite or 3/8" plywood, 6" X 9"
1 Egg-beater type hand drill
2 ft. 1" X 1" extruded aluminum angle stock
1 ft. 3/8" dia. bar stock (see text)

Misc.—screws, 1/4" threaded rod stock, wing nut, hex nut, flat washers, 1" dowel rod, etc.

When you are ready to wire an experimental circuit, mount all tube sockets, brackets, and special terminal strips on the breadboard chassis with No. 6 sheet metal screws.

If the adaptor plates are to be used, mount the miniature tube sockets in them using 1/4-inch 4-40 machine screws and small hex nuts. Mount the adaptor plates, in turn, on the chassis proper, using longer sheet metal screws and 1/4-inch stand-off spacers. They are mounted over the large tube socket holes.

All tube sockets are mounted so that the tubes plug in below the chassis. This permits all wiring to be kept above the chassis and exposed and makes it easy to do tests and experimental circuit changes.

Lap joints are used for all wiring, with ground, "B plus," and filament connections made through the bus bars.

In addition to simplifying the original assembly and wiring job of an experimental circuit, the use of a breadboard also makes the disassembly job easier. The exposed wiring and lap joints permit the experimenter to tear down a circuit in "jig" time.

Jig for Soldering-gun Tips

An inexpensive way to keep your soldering gun in top operating condition is to have a stock of spare tips on hand. Soldering-gun tips soften and corrode with use and should be replaced when this occurs.

To keep your shop well stocked with tips, the jig layout shown in Fig. 107 will help you turn out new tips as you need them, at small cost, and with only a few minutes work. It can be made from a few scraps of wood and a small strip of 18-gage aluminum. The stock for making the tips is a roll of No. 10 soft-drawn copper wire. As each tip you make will require only a little over 7 inches of wire, one roll will last a long time.

To make the jig, cut the rectangular base (A) from hard wood, such as maple or oak. Prepare the forming block (B) by cutting it to

size and then beveling it at an angle of 45° . Hacksaw and file an aluminum strip (C) to size. Drill and countersink it for $\frac{1}{2}$ -inch No. 6 flat-head wood screws. Secure the strip (C) to the side of the forming block (B), as shown in the illustrations, using wood screws. Let the strip project downward toward the base a distance of about $\frac{1}{16}$ inch beyond the bottom of the forming block when you do this. The projection will fit into a groove chiseled into the base to prevent the strip from bending while the tip is being made. The right end of the strip projects exactly $1\frac{3}{8}$ inches beyond the end of the beveled forming block. After you have chiseled out a recess for the bottom edge of the aluminum strip, screw the forming block to the base. By sinking the strip in the base this way, a degree of rigidity is obtained that is of great help in using the jig.

As a final step, screw two round-head wood screws into the base near the aluminum strip. (Be sure to separate the screws from the strip by the diameter of the No. 10 wire to be used.) These holding screws (D) are allowed to protrude above the base about $\frac{1}{4}$ inch.

To use the jig, first cut a length of wire exactly $7\frac{1}{4}$ inches long. Slide the end of the wire between the strip and the holding screws to the starting line (E), and bend the wire around the end of the strip. Using a pair of gas pliers or long-nose pliers, squeeze the wire around the bend close to the strip on each side and then continue to bend it by hand so that it follows the contours of the forming block.

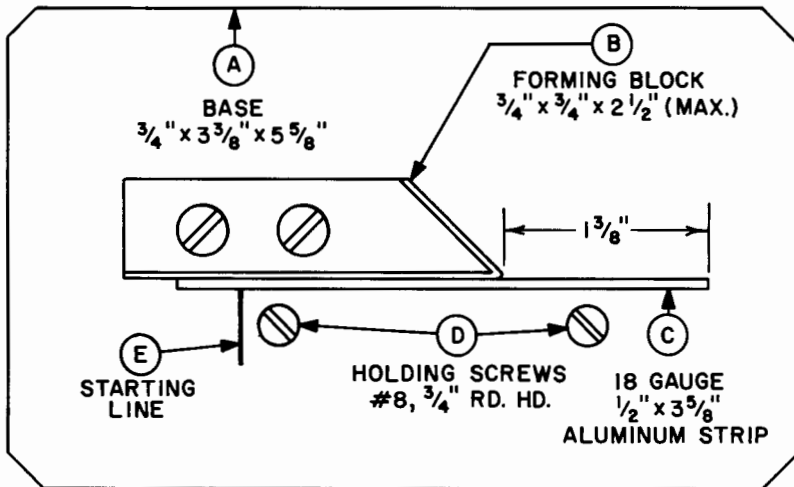

Fig. 107—Job layout. Letters refer to parts as explained in text.

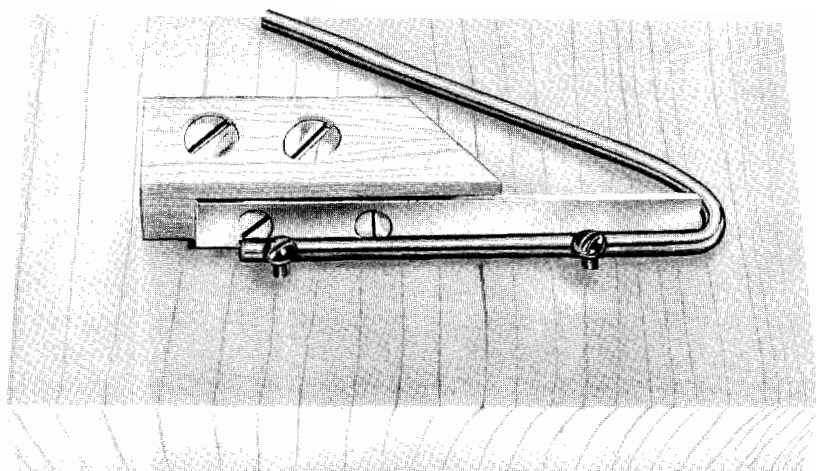

Fig. 108—Second step in making a tip for the soldering gun is to bend the $7\frac{1}{4}$ -inch strip of wire back over the metal forming piece.

Place the clamping nuts (supplied with the gun) on the wire. Make certain that the threads face the right way to permit fastening to the gun. Then bend $\frac{1}{4}$ inch of each end of the top; insert into the gun's retaining holes; and tighten the clamping nuts. The new solder tip is now correctly mounted. Tin the tip, and the gun is ready for use.

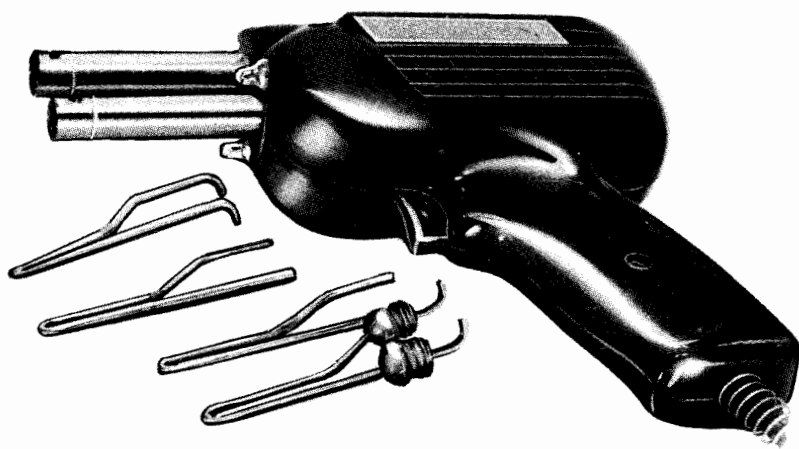

Fig. 109—Soldering gun with new tips ready for assembly. End of tips that fit into gun barrels must be bent slightly after the clamping nuts are attached.

Another useful accessory for the electronic workshop is a d.c. power supply that can be used to drive small motors, such as those used in hand-carving tools. The d.c. supply will give you a higher motor speed without excessive heating of the motor.

Construct the base and uprights from $\frac{3}{4}$ -inch wood stock and drill a $\frac{1}{4}$ -inch hole in each of the upright pieces to pass the electric cord and wiring. Then mount and wire the socket (SO1), capacitor (C1), and rectifier (SR1) as shown in the diagrams.

Cut a protective shield from hardware cloth or wire screen, then bend and fasten it with wood screws and washers. As an added safety measure, tape the exposed socket connections.

The d.c. supply must be used with motors drawing less than 0.5 ampere; those drawing more current will burn out the rectifier. It can only be employed with motors using d.c. or a.c./d.c.; motors using only a.c. will not work on the d.c. output of the rectifier.

8

MAKING YOUR OWN TEST EQUIPMENT

As you progress in your electronic experimenting, you will need equipment that will enable you to test, calibrate, and trouble-shoot your projects. The easiest way for the beginner to obtain test equipment is to buy it in kit form and assemble it himself. The instructions with kits are detailed and all parts are ready for mounting on a predrilled chassis. Often, you can buy a kit for less than the parts would cost for a home-built project.

Although home-built units have the advantage of giving layout and construction experience that you won't get from kit or factory-built units, commercial equipment has flexibility and accuracy not usually available in home-built equipment.

Which Instrument First?

The type of test equipment you need will depend on the area of electronics that interests you most. A voltmeter is basic to all types of electronic work; beyond that, your choice of instruments will be determined by your area of interest.

The usefulness of other test units will be determined on the basis of the type of equipment you are going to build. The audio fan will need an audio signal generator and the ham enthusiast will want an r.f. oscillator. The only major piece of equipment not included in this section is the oscilloscope. An oscilloscope project is difficult, and the parts required are expensive. If you want to build your own, investigate those designed and sold by the kit companies.

Make Your Own Multi-tester

The first piece of test equipment to be acquired by the electronic experimenter is, usually, a multi-tester, or VOM. Once in a while, though, this acquisition is delayed while the necessary capital accumulates. The multi-tester described here is not intended to replace any of the VOM's or VTVM's available in finished or kit form, but it will enable you to have the fun of electronic experimenting while you are waiting for the "real thing." Best of all, it's guaranteed not to deflate any but the most meager of pocketbooks.

The neon tester will measure a.c. voltages between 40 and 200 volts, d.c. voltages between 60 and 300 volts, and resistances between 10,000 and 250,000 ohms.

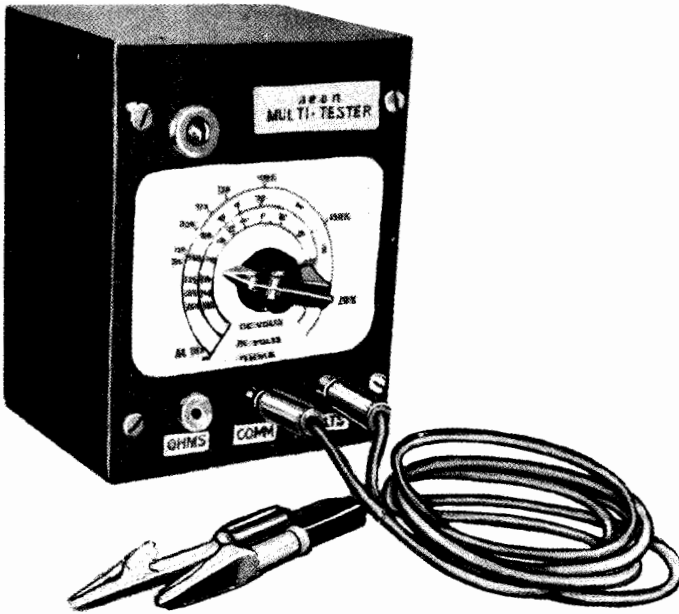

Fig. 110—Multi-tester with neon bulb which is used for economical construction.

A minimum amount of time is necessary to construct the tester. As a matter of fact, to duplicate the unit described requires only the drilling of seven holes. The tester was housed in a 3-inch by 4-inch by 5-inch metal utility box. As there are no critical components or wiring in the unit, successful operation is practically guaranteed after construction and calibration.

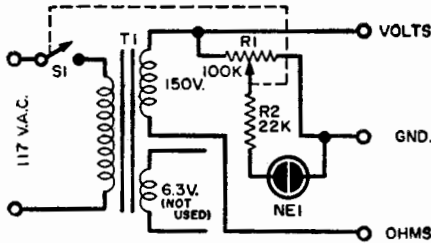

Fig. 111—Schematic diagram of multi-tester unit.

PARTS LIST

- 1—7" X 9" X 2" aluminum or steel chassis. (Bud CB-790, CB-1192, AC-406; ICA 29006, 4004, 1569; Par-Metal B-4511, C-4511; Premier CH-404)
- 3—Ft. #12 tinned bus bar; 4—Ground lugs
- 30—Inches 1" X 1" X 1/16" extruded aluminum angle. (Reynolds "Do-It-Yourself")
- 2—7-terminal tie-point strips (Jones #2007)
- 2—Sq. ft. .050 sheet aluminum or 20 ga. steel. (Amount depends on number of brackets and adaptor plates)
- 1—Pkg. #6 X 3/8" sheet metal screws

Wire the power transformer T1 to the panel but mount it inside the box. (The transformer leads are not long enough to mount both the wire and the transformer inside the bottom of the box.) Mount the neon bulb (NE1) by forcing it into a rubber grommet on the panel of the instrument. Be sure to mount the grommet on the panel first, then gently slide the bulb into it. Also, don't forget to use insulated tip-jacks through the metal panel of the instrument. However, if you make your own box out of Masonite or plywood, this won't be necessary.

The filament winding on the power transformer is not used. Taping up these leads is a better practice than simply cutting them off, for you may eventually want to use the transformer for another purpose.

The voltage calibration of the neon tester is best accomplished by comparing it with another multi-meter. Meters of this type are available in such great profusion that you should have little difficulty in borrowing one temporarily. If a friend with a VOM is not immediately available, try the local radio/TV service shop. The calibration can be done "on the spot" in a few minutes if the procedure and necessary test setup are prepared beforehand.

Before beginning the actual calibration, prepare a finished blank

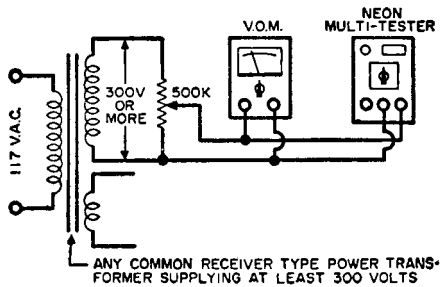

Fig. 112—Voltage calibrating setup for multi-meter.

scale. It should consist of three concentric circular scales without calibration marks. For best results and greater durability, use India ink in preparing the scale and, later, in making the calibration marks and figures. The scale can be made on a white index card.

Put the blank scale in place on the front panel of the tester. Because you will want to remove it later for the finishing touches, fasten it in place with two small tabs of Scotch tape.

Voltage calibration can be effected with the setup shown in the diagram. The transformer, which can be any common receiver-type power transformer, supplies the voltage necessary to calibrate the upper end of the scale. With the 500K pot adjusted so that the "standard meter" reads 40 volts, adjust the neon tester control (R1) until the neon just ignites and begins to glow. The voltage at this point (as read on the "standard meter") should be marked on the blank scale in pencil. The pencil mark will be inked over later.

Adjust the 500K pot to 45 volts and continue to adjust the neon tester control until the neon just glows. Then mark this new point on the scale. Continue until the scale is completely calibrated with as many points as desired. This one procedure calibrates both the a.c. voltage scale and the d.c. voltage scale.

Ohms calibration is best accomplished by digging around in the junk box and finding as many different resistor values as possible between 10,000 and 250,000 ohms. If you are missing any essential values, they can be made from series or parallel combinations of available resistors.

To calibrate the ohms scale, place the known resistance between the common and ohms lead of the neon tester and adjust R1 until NE1 just begins to glow. Mark this point on the scale with the resistance value of the resistor. Continue the procedure until sufficient resistance points have been obtained.

Remove the pencil-calibrated scale from the neon tester. Now, simply multiply the a.c. scale by 1.41 and mark in the d.c. voltage calibration. For example, the a.c. voltage calibration of 100 volts will correspond to the d.c. calibration point of 141 volts. The reason for this becomes apparent when we realize that an r.m.s. a.c. voltage of 100 volts, as read on any meter, has a peak voltage of 141 volts. Because the neon lamp in the tester responds to the peak voltage applied, a d.c. voltage (which of course has a peak voltage corresponding to its average value) will read 1.41 times the a.c. voltage.

Then go over the pencil-calibrated scale with India ink. The surface of the scale can be coated with polystyrene Q dope to give it a hard,

glossy finish. If the lettering is carefully done, the results will look quite professional.

The neon tester is now ready for operation. When you use it, adjust R1 to the point where the neon lamp lights up.

Vacuum-tube Voltmeter

The vacuum-tube voltmeter (VTVM) as described here can be built at very low cost. It has an input impedance of 12.7 megohms on all ranges and three d.c. voltmeter ranges of 0-6, 60, and 600 volts full scale. There are also three ohmmeter ranges, which make measurements of 10 ohms to 10 megohms quite feasible.



Fig. 113—Low-cost VTVM.

A 0-1 milliamperemeter is used. This can be purchased for approximately \$3.50. (Any 0-1-milliamperemeter can be used—the determining factor is mainly one of price.) The meter is of the moving-

vane type and has an internal resistance of about 1,000 ohms. If a moving-coil type of meter is used, a 910-ohm, 1/2-watt resistor should be placed in series with the meter when it is employed in the VTVM.

The VTVM is housed in an aluminum case which measures 7 inches by 5 inches by 3 inches. Layout and construction details can be seen in the drawing and photograph.

A big item in the economy of construction is the use of 5 per cent resistors for the voltage divider and ohmmeter multiplier. Some of the resistors in the voltage divider and ohmmeter multiplier are in parallel—in order to achieve the exact calculated value. For example, one of the values called for was 900,000 ohms. Because this is not a standard value, two 1.8-megohm resistors, which are standard, were placed in parallel (see R5 and R6, R7 and R8).

PARTS LIST

B1—4.5-volt "C" battery (or 3 penlite cells in series)	R9—100,000-ohm, 1/2-watt, 5% resistor
C1, C2—50- μ fd., 25-volt electrolytic capacitor	R10—100,000-ohm, 1/2-watt, 5% resistor
C3—.01- μ fd., 600-volt ceramic capacitor	R11, R12—1800-ohm, 1/2-watt, 5% resistor
M1—0.1-ma. Shurite meter or equivalent (see text)	R13—100-ohm, 1/2-watt, 5% resistor
R1, R14—2.7 megohm, 1/2-watt, 10% resistor	S1—S.p.s.t. toggle switch
R2, R3—1000-ohm potentiometer	S2—D.p.d.f. toggle switch
R4—5000-ohm potentiometer	S3—3-pos., 2-pole rotary switch
R5, R6—18-megohm, 1/2-watt, 5% resistor	T1—Power transformer, 125 volts at 15 ma., and 6.3 volts, at 0.6 amp. (Stancor PS8415)
R7, R8—1.8-megohm, 1/2-watt, 5% resistor	V1—12AU7 tube

The d.c. volts test lead should be a shielded cable. A 3-foot length of single-conductor microphone cable is ideal for this purpose. The common test lead and the ohms test lead are made of standard rubber-covered test lead wire. No jacks were used for the test leads as there is no need to disconnect them.

The most painstaking operation in constructing the VTVM is making the meter scale. First, disassemble the meter by bending up the four ears on the back of the meter. Next, carefully remove the scale. Lay the scale on a piece of paper and fasten it temporarily in place with Scotch tape. Divide the scale into six equal parts (the meter scales are to be multiples of six instead of ten). Use the meter readings listed in Table 1.

TABLE 1

0-1 MILLIAMMETER READING	NEW VOLTS SCALE CALIBRATION
0	0
.166	1
.33	2
.50	3
.66	4
.83	5
1.0	6

TABLE 2

NEW VOLTMETER SCALE READING	NEW OHMMETER SCALE CALIBRATION
VOLTS	OHMS
.546	1
1.0	2
1.385	3
1.715	4
2.00	5
2.25	6
2.47	7
2.66	8
2.84	9
3.00	10
3.60	15
4.00	20
4.50	30
5.00	50
5.46	100
5.72	200
5.89	500
5.94	1000
6.00	INFINITY

Transfer the scale calibration to a new scale. (This can be drawn on a white index card.) Make an arc corresponding to the original meter-scale arc. Draw lines to the seven division points; this will divide

the scale into six equal parts. Now subdivide each of the six dimensions into five equal subdivisions; these correspond to 0.2, 0.4, 0.6, and 0.8.

The next step is to draw in the ohmmeter scale. Do this by referring to Table 2. Draw another arc for the ohmmeter scale just above the voltmeter scale. From the data in Table 2, draw a line on the new scale through the center point and the voltage scale reading indicated. The arc and calibration points and the lettering for both scales can be inked in with India ink and the pencil guide lines can be erased. The scale can then be cut to size. Use paper rubber cement over the original meter scale to hold it in place.

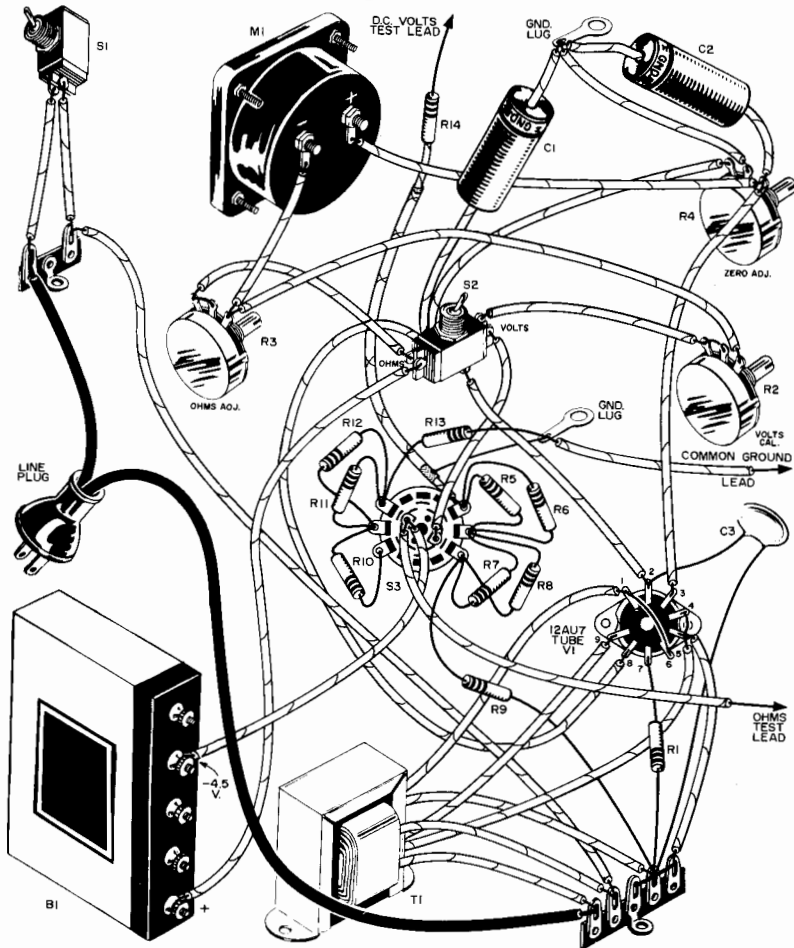

Fig. 114—Pictorial wiring diagram shows how various components are connected. Note particularly the wiring around switch S3 and shielded lead attached to R14.

After the unit has been constructed, the only calibration necessary is that for the d.c. voltage. A 4.5-volt battery can be used as a convenient source of known voltage. Temporarily remove the battery from the circuit. Set the meter to the 6-volt position. Set R4 so that the meter reads zero. Connect the voltage test probe to the positive end of the 4.5-volt battery, then connect the common lead to the negative end of the battery. Adjust R2 inside the VTVM so that the meter will read 4.5 volts. This automatically calibrates all the voltmeter ranges. The battery can now be reinstalled in the VTVM.

The ohmmeter is calibrated in use by adjusting R3 on the front panel for full scale when the function selector switch is in the ohms position.

Check Your a.c. Calibration

After you have finished putting together the VTVM, a stable a.c. voltage source will serve to adjust the calibration of the a.c. scales. When you are going to make some critical a.c. measurements, you can recheck the accuracy of your VTVM or multi-meter with a voltage calibrator.

Calibration of the d.c. ranges of a meter is relatively simple because dry cells and batteries are universally available. Flashlight cells have an output voltage of 1.54 volts when new. "B" batteries are available in standard 45-, 67.5- and 90-volt sizes for calibration of the higher voltage ranges.

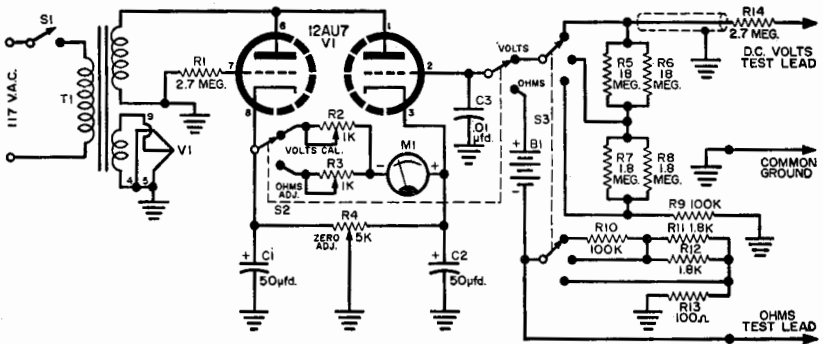

Fig. 115—Wiring diagram of test instrument. Note absence of rectifier which is found unnecessary in this circuit.

Two 67.5-volt batteries, for example, can be connected in series to give over 135 volts in order to check the meter scale in the 150-volt section where many important measurements are made. (Actual voltage of each battery, when fresh, will be 69.3. The output voltage

of a fresh battery is a physical constant and is dependent on the electro-chemical makeup of the battery.)

Calibrating the a.c. ranges of the meter is a problem. The power-line voltage, which is your source of a.c., varies from instant to instant and from hour to hour. Another a.c. meter of known accuracy which is needed to check the power line and a.c. scale is usually not readily available.

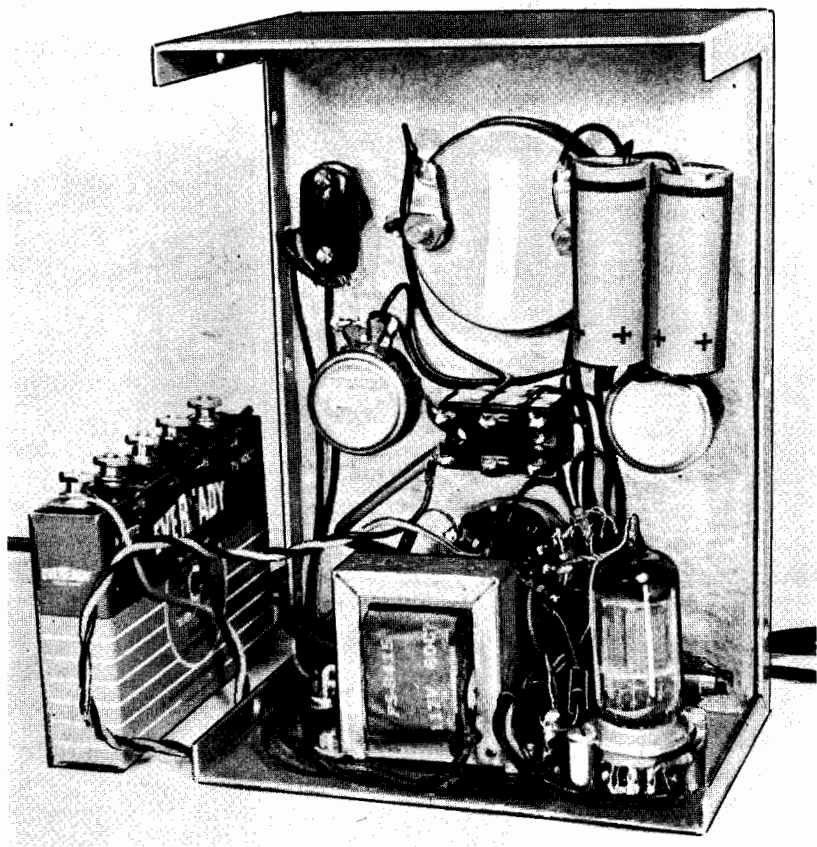

Fig. 116—Inside-the-case view of VTVM shows placement of parts used in original model.

Here is a simple means of calibrating the a.c. ranges by means of the previously calibrated d.c. voltage ranges. All that is required is a simple half-wave rectifier system. Use a 130-volt selenium rectifier

(SR1) of 30-milliamperes or higher current rating, a 22-ohm surge resistor (R1), and a 22,000- to 47,000-ohm load resistor (R2). A 0.2- or 0.5-microfarad capacitor plus some wire and solder completes the parts list.

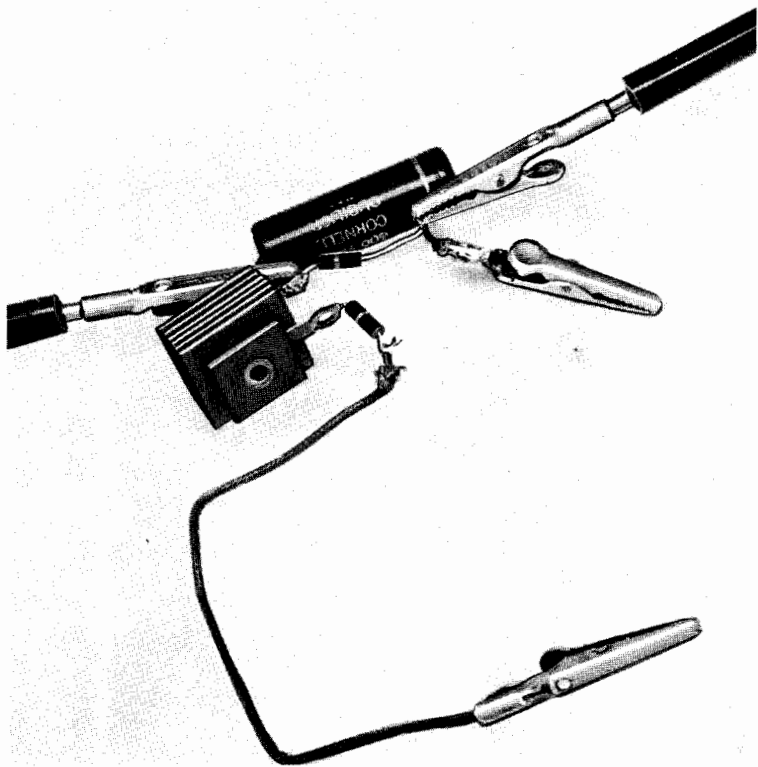

Fig. 117—Circuit of voltage calibrator is so simple that a chassis is not necessary.

Measure the d.c. voltage across points C and D in Fig. 118. It almost equals the peak value of the a.c. voltage. Allow for about 1 per cent drop through R1 and SR1. Now switch the meter to its a.c. voltage between A and B. Set the a.c. calibration control of the meter to read 0.7 (actually 0.707) of the previously measured d.c. voltage.

For example, if the d.c. voltage across C, D is measured as 160 volts (this would correspond to the peak a.c. voltage) the a.c. r.m.s. voltage is 112 volts (160×0.7). Because the line voltage may vary from one moment to the next, switch back to the d.c. scale immediately after setting the a.c. calibration control. Recheck the d.c. reading, then switch back again to the a.c. scale to recheck the line voltage, which may have shifted.

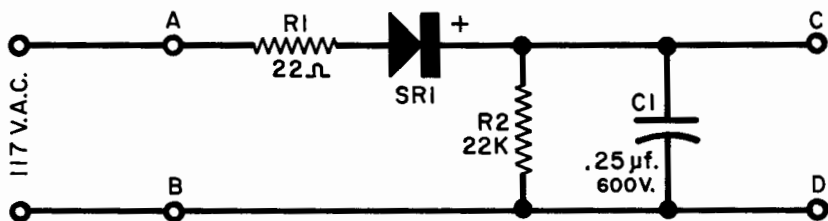

Fig. 118—Circuit layout of voltage calibrator.

Certain precautions should be observed, as this little gadget is operated directly from the a.c. line. Never touch the metal cabinet of your meter or uninsulated sections of the test probes and an external ground simultaneously. Make all connections and disconnections of your test clips or probes only when the calibration circuit is not plugged in.

Do not touch any water pipes, and avoid damp floors when working on any device which has its common or B— return connected directly to the a.c. line.

Economy Transistor Checker

The Economy Transistor Checker performs two sensitive tests which will quickly tell you if a transistor has been damaged due to overload or contamination of the germanium; if the transistor is shorted or open-circuited; or if it is just excessively leaky.

Construction of the transistor checker should take about one evening. It is housed in a 3-inch by 2-inch by 5¼-inch Minibox. The layout is not critical.

The transistor socket requires a 5/32-inch by 11/32-inch rectangular hole. Lay out the hole size carefully on the front panel with a scribe, then drill two 1/8-inch holes within the rectangle. The remaining aluminum can be readily removed in a few minutes with a small file.

Mount the 6-volt battery on the rear cover of the checker. Bend the strap of scrap aluminum so that it fits around the battery and clamp it firmly into place.

Wiring the unit should present no problem if the wiring shown in the diagram is carefully followed. If you have never worked with transistors, you should realize that particular care must be exercised regarding battery polarities and short circuits, etc. Usually, you get only one chance with transistors—unless you're fortunate and fast.

Solder the wire from the checker directly to the battery terminals. The battery should last for its shelf life, since battery drain is small and intermittent.

To test a transistor in the checker, it is first necessary to know which basic type of transistor you have, i.e., whether it is a PNP or NPN type. You can determine this from the manufacturer's description or from the polarity of the battery connections to the transistor if it is in a piece of equipment. A PNP transistor always has the collector supplied from the negative pole of the battery and the emitter supplied from the positive pole. The NPN type is reversed completely, i.e., the collector is supplied from the positive pole and the emitter from the negative pole of the battery.

Once this fact is established, it is only necessary to set the switch on the checker front panel to the leakage position for the type of the transistor under test. Plug the transistor in the socket provided and observe the reading on the meter. The data in Table 3 gives representative readings for several transistor types.

TABLE 3. Typical leakage and gain readings obtained for several different types of transistors.

Transistor Type No.	Leakage Reading	Gain Reading
CK722	0.1	0.3
2N107	0.1	0.5
2N45	0.2	0.4
2N78	0.05	0.55
2N94	0.0	0.3
2N137	0.1	0.7

In general, the lower the leakage, the better the transistor. It can then be noted that the inexpensive low-frequency types usually exhibit higher leakage than the more expensive low-frequency types.

To check the common-emitter current gain, set the switch to the gain position. An upward swing indicates a current gain. If the leakage reading was very low, the meter reading, multiplied by 100, can be called the approximate "beta" (β) for the transistor. At any rate, the meter reading can be checked against Table 3.

If the transistor has an appreciable amount of leakage, the current gain (β) can be obtained by observing the change in meter reading when switching from the leakage to gain positions. The difference between these two readings divided by the change in base input current which occurs when switching between leakage and gain positions will give the common-emitter current gain. For example, in the transistor

checker the base input current is 10.7 microamperes. Thus, if the meter records a change of 0.5 milliampere in going from leakage to gain positions, the approximate current gain would be 0.0005 divided by 0.0000107, or 46.7.

Many manufacturers rate transistor gain as "alpha" (α), which is the common base current gain. This is a number always less than "1" for junction transistors and is generally of the order of 0.98.

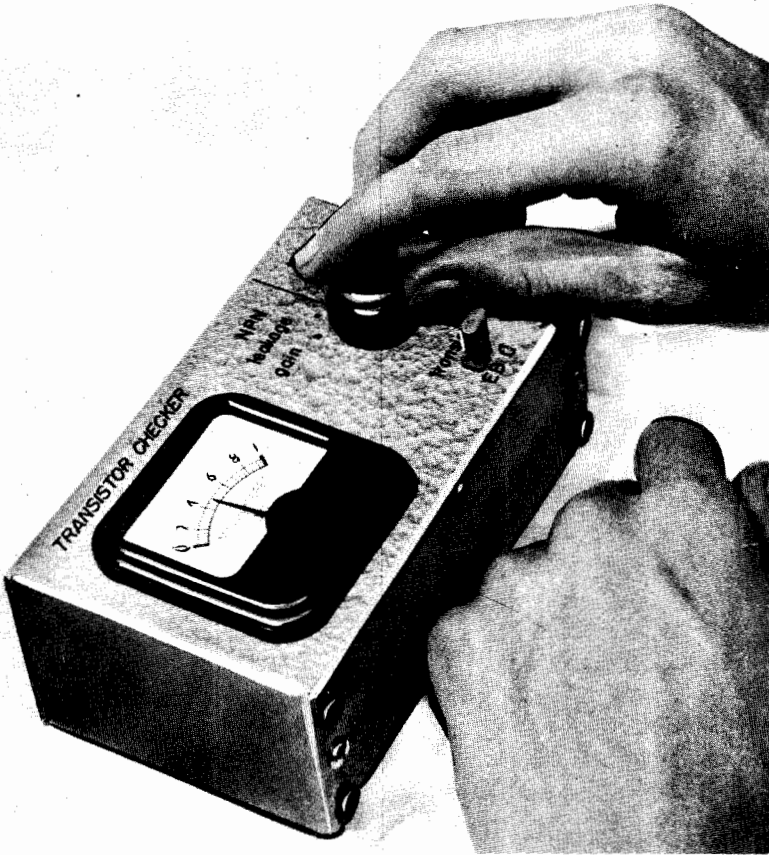

Fig. 119—Transistor checker.

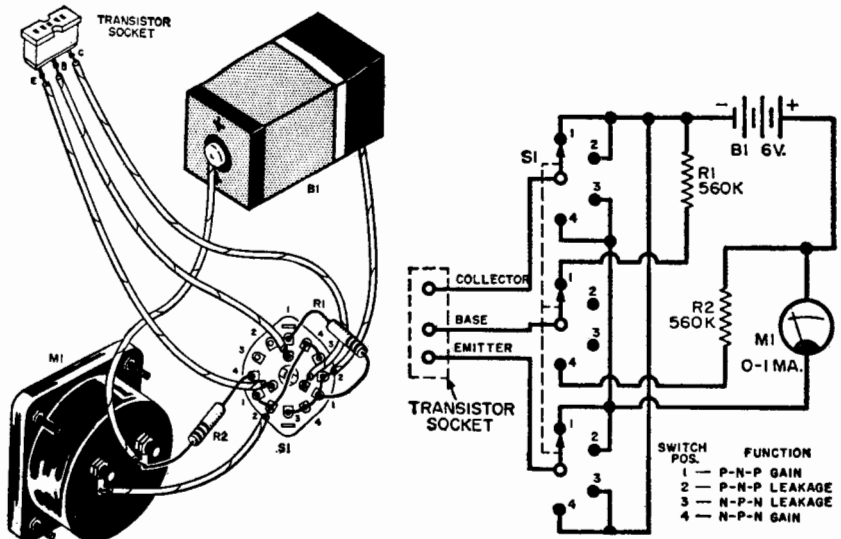

Fig. 120—Pictorial and schematic diagrams show how parts are interconnected.

Power Supply for Transistor Experiments

The transistor power supply shown in Fig. 121 is a high-quality unit which has been designed especially for experimental test-bench operation. It is capable of handling a current tremendously greater than will ever be required in the average transistor setup, and the potentiometer specified will take many, many thousands of operations before it even feels inclined to wear out. Cheaper potentiometers begin to wear out relatively soon after being put into operation—and once wear begins in earnest, the wiper and the resistance element “go to pot” in a hurry.

A diffused junction germanium 1N91 rectifier has been used to provide a low voltage drop. The 1N91 is very small, considering its current-handling ability, and it costs little more than a selenium unit of the same rating. A pair of 25-microfarad electrolytic capacitors and a 8.5-henry choke take care of adequate filtering. A 1,000-ohm bleeder resistor connected across the input to the filter maintains a constant load on the supply. Everything runs cool except the potentiometer, which has a fairly high current running through it to overcome any tendency toward erratic operation due to varying contact resistance.

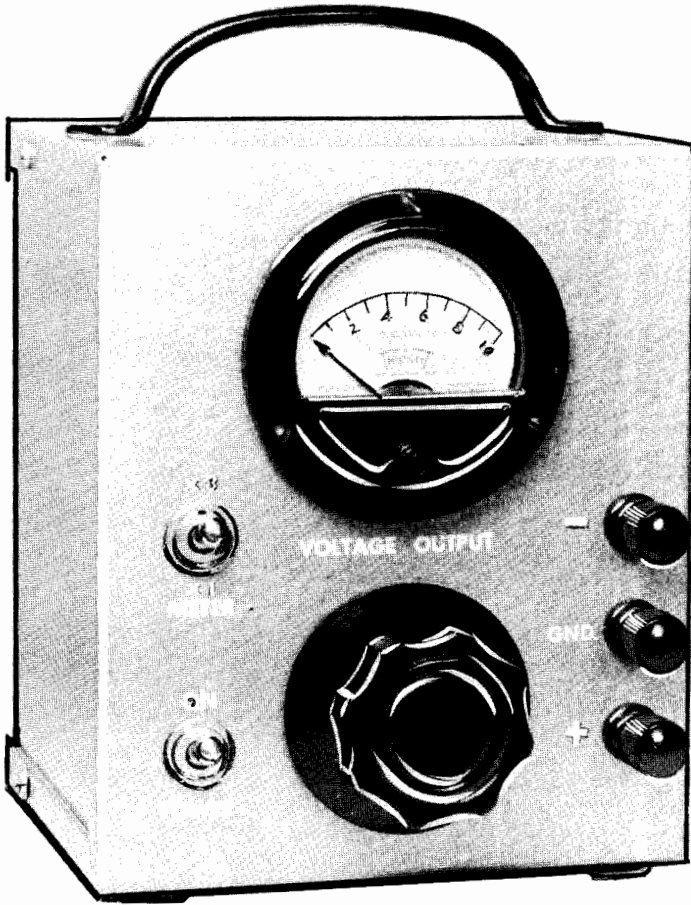

Fig. 121—Experimenter's transistor power supply.

Voltage output from the supply is continuously variable from zero to 30 volts d.c. A high-quality meter, connected across the output terminals, monitors the d.c. level. Two voltmeter ranges are provided: The meter range itself—which is 0–10 volts; and an $\times 3$ range—obtained through the use of a 20,000-ohm, 1 per cent precision series multiplier resistor which extends the scale to 30 volts. Each subdivision on the meter scale is equivalent to 0.2 volt on the low range and 0.6 volt on the high range. It is possible to set the output voltage to within one subdivision, i.e., 0.2 volt, on the low range and better than one subdivision on the high range.

PARTS LIST

C1, C2—25- μ fd., 25-volt electrolytic capacitor (C-D BBR-25-25 or equal)	T1—25.2-volt, 1-ampere, filament transformer (Stoncor P6469 or equal)
CH1—8.5-henry, 50-mo. filter choke (Stoncor C-1279 or equal)	1—4" x 5" x 6" 2-piece gray ham- mertane aluminum box
CR1—Diffused junction germanium rectifier (G.E. Type 1N91 or equal)	1—Screen door pull (for handle)
M1—0-10 volt voltmeter, 1000 ohms per volt (Triplet 221-T or equal)	1—Rope cleat
R1—100-ohm, 25-watt potentiometer (Ohmite H-0151 or equal)	1—Power cord
R2—10-ohm, 1-watt composition resistor	1—2-lug tie point
R3—1000-ohm, 10-watt wire-wound resistor	1—5-lug tie point
R4—20,000-ohm, 1% precision resistor (IRC Type DCC or equal)	4—Sponge rubber discs (for feet)
S1, S2—S.p.s.t. toggle switch	1—Fluted knob, flange-type, 2 $\frac{1}{16}$ " diameter
	3—Binding posts
	Misc.—hardware, solder lugs, extruded fiber washers, decals, rubber grommet, wire, solder, etc.

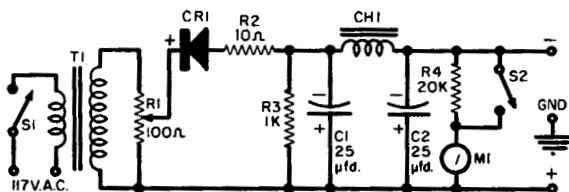

Fig. 122—Schematic diagram for transistor power supply.

The circuit diagram of the transistor supply is shown in Fig. 122. The unit fits nicely into a 4-inch by 5-inch by 6-inch grey hammetone aluminum box. Both “+” and “-” terminals are insulated from the box by means of extruded fiber washers pressed into the holes from the inside. The Bakelite base of the terminal provides insulation on the panel side. The center, or gnd, terminal is connected directly to the box to permit the box to be grounded whenever necessary. Either the “+” or “-” terminal may be grounded to the box simply by connecting a short jumper wire between the appropriate terminal and the center terminal.

The meter multiplier resistor is located on the meter switch. All other resistors and capacitors are secured by their leads to a 5-lug tie strip which, in turn, is secured under the nut of the negative terminal on the meter. The diffused junction germanium rectifier connects between the uppermost terminal on this strip and the center lug on the potentiometer. A 2-inch to 2.5-inch length of No. 20 bare, tinned copper wire is soldered to the lower lead of the rectifier to extend its length. A

long lead is desirable here because the potentiometer runs hot, and the greater length allows the heat conducted to the lead to be dissipated before it can reach the rectifier.

A series of 3/8-inch-diameter holes drilled in the back of the box permits adequate ventilation for the potentiometer. Direct ventilation can be obtained by drilling a 1-inch-diameter hole in the bottom of the box directly under the potentiometer. In this case, the series of holes at the bottom of the back cover of the box can be eliminated. Either method will work well, because the heat dissipated by the potentiometer is not severe. A 2-lug tie point, secured under one of the screws holding the filter choke, takes care of the power-cord connections.

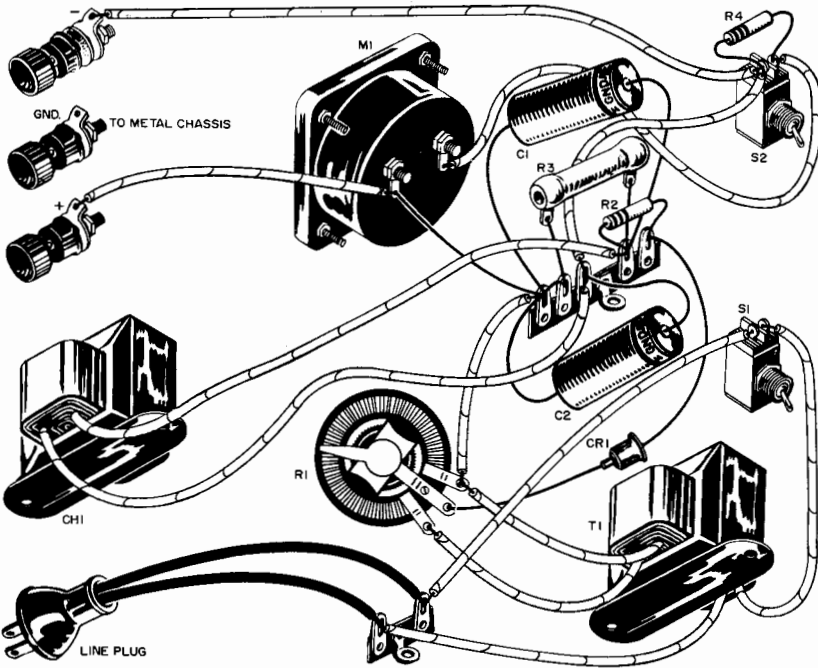

Fig. 123—Pictorial of power supply shows how parts are inter-connected.

When using this supply, keep in mind that adequate series resistance should be employed in all necessary leads to prevent transistor burnout in the event of a runaway circuit. This is, of course, no different from the precautions which should be taken when batteries are used. Buy all the batteries you like for your finished transistorized equipment, but build this supply for use on your experimental bench. Not only will it give the voltage you want when you want it, but it also will tell you

what batteries will be needed for finished jobs as well. You can extend the life of the batteries in portable transistorized equipment by operating the equipment from this supply whenever you are at home and an a.c. outlet is nearby.

Audio Oscillator

There is no need to emphasize the audio-frequency generator—especially to the audio experimenter. For, in this field, it is as basic as a voltmeter.

The audio-frequency generator covers the entire audio-frequency range from 22 cycles to 12,000 cycles; such coverage effects quite a saving in the cost of switches and other components usually found in most audio-frequency generators. The frequency control is an inexpensive potentiometer rather than an expensive multigang variable capacitor or multigang potentiometer. And, best of all, only one tube is used.



Fig. 124—Audio oscillator.

The oscillator is housed in an aluminum 6-inch by 6-inch by 6-inch box known as LMB Type 666. One-half of this box is an L-shaped piece which makes it convenient to use the box as the panel and base. No separate chassis is necessary. The unit is so simple that the parts can be easily mounted, wired, and serviced right on the bottom of the cabinet.

Mount the tube socket on metal standoffs or spacers to clear the socket pins from the metal cabinet. It is advisable to wire as many capacitors, resistors, etc., as you can to the socket before mounting.

Mount the two 3-watt bulbs (PL1 and PL2) by soldering the screw sides of the base to a terminal strip. Then solder the connecting wires directly to the lamp base. No lamp sockets are needed since the lamps are used at only a very small fraction of their rating and should last as long as any other component. Incidentally, don't expect to see any visible glow from these lamps when the oscillator is operating.

After the unit is constructed, the only adjustment necessary to put it into operation is calibrating the main frequency control. This could pose a small problem for some, because another piece of test equipment is required which you may or may not have.

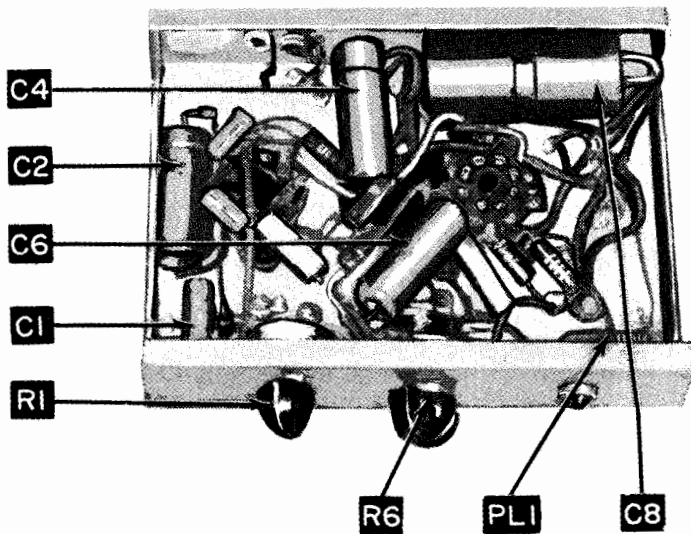

Fig. 125—View of audio generator. Note placement of major parts.

PARTS LIST

C1—10- μ fd., 150-volt electrolytic capacitor	R6—470-ohm, $\frac{1}{2}$ -watt fixed resistor
C2—0.47- μ fd., 200-volt paper capacitor	R7—220,000-ohm, $\frac{1}{2}$ -watt fixed resistor
C3—0.02- μ fd., 200-volt paper capacitor	R8—68,000-ohm, $\frac{1}{2}$ -watt fixed resistor
C4—0.01- μ fd., 200-volt paper capacitor	R9—5000-ohm resistor
C5—80- μ fd., 150-volt electrolytic capacitor	R10—10,000-ohm potentiometer, linear taper
C6a/C6b—40/80 μ fd., 150-volt electrolytic capacitor	S1—S.p.s.t. switch on R10
C7—25- μ fd., 25-volt electrolytic capacitor	SR1—65-ma. selenium rectifier
CH1—7-henry, 50-ma. choke (Stancor C1707)	T1—Power transformer, 125 volt at 15 ma., 6.3 volt at 0.6 amp. secondary (Stancor PS8415)
PL1, PL2—3-watt, 115-volt lamp	V1—6U8 tube
R1—750-ohm, $\frac{1}{2}$ -watt fixed resistor	1—6" x 6" x 6" aluminum box (LMB Type 666)
R2—270-ohm, $\frac{1}{2}$ -watt fixed resistor	
R3, R4—10,000-ohm, $\frac{1}{2}$ -watt fixed resistor	
R5—5-megohm potentiometer with reverse logarithmic taper	

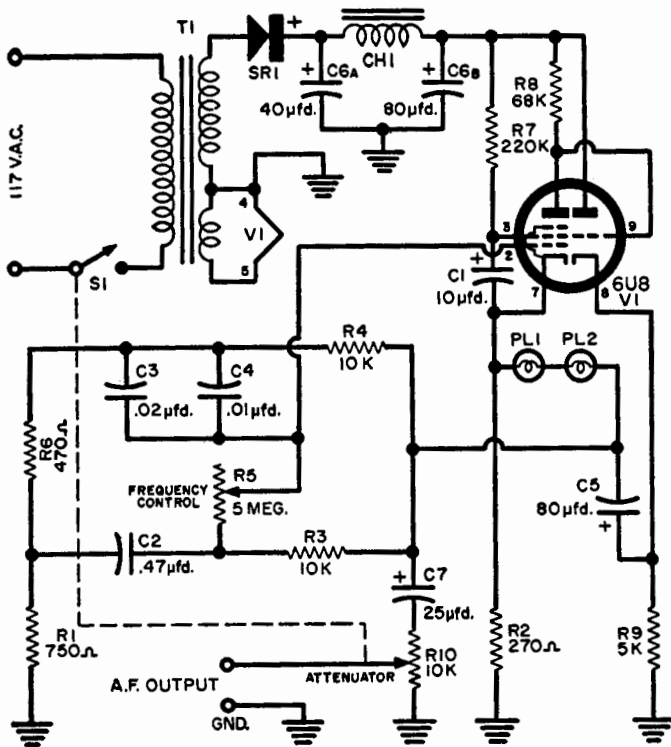

Fig. 126—Complete wiring details for audio oscillator.

Two possible methods of calibration are shown in Fig. 128 (1). It is assumed that you can borrow or obtain the use of the necessary equipment long enough to calibrate the audio signal generator. The method shown in (A) is the simplest. Feed the audio generator into an audio-frequency meter which will read the signal output frequency directly.

The method shown in (B) is based on comparing the frequency out of the "Economy" generator with that of another calibrated audio generator known to be reasonably accurate. Feed one generator into the horizontal input of an oscilloscope. Feed the other generator into the vertical input of the oscilloscope. Set the calibrated generator on a frequency point to be calibrated. Adjust the uncalibrated generator

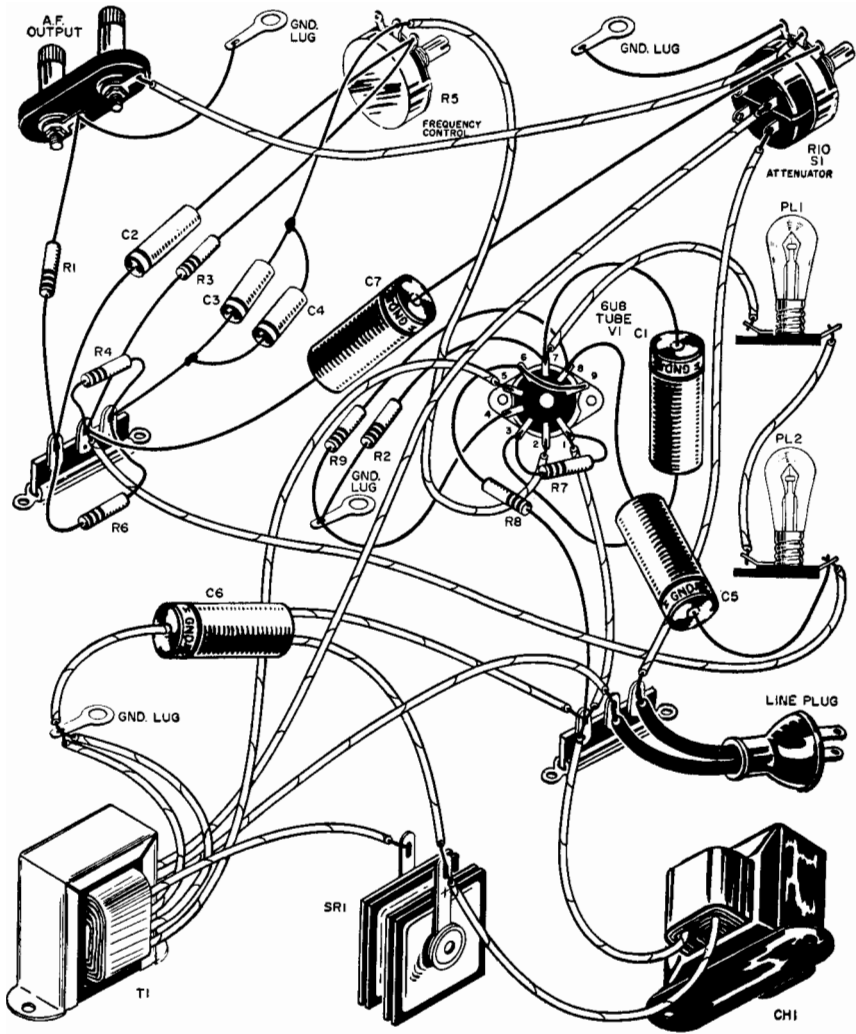
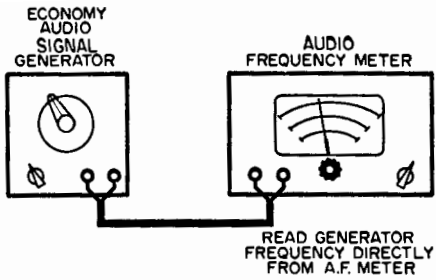

Fig. 127—Pictorial diagram of hook-up of audio-generator components.

until a circle or ellipse is obtained on the 'scope face. The two generators are then at the same frequency. This procedure should be repeated for all the points to be calibrated.



(A)

SCOPE PATTERN WILL BE SLOWLY ROTATING
CIRCLE AS OSCILLATORS ARE ADJUSTED TO
SAME FREQUENCY. WHEN EXACT, SCOPE WILL
EXHIBIT ANY OF THE FOLLOWING PATTERNS:

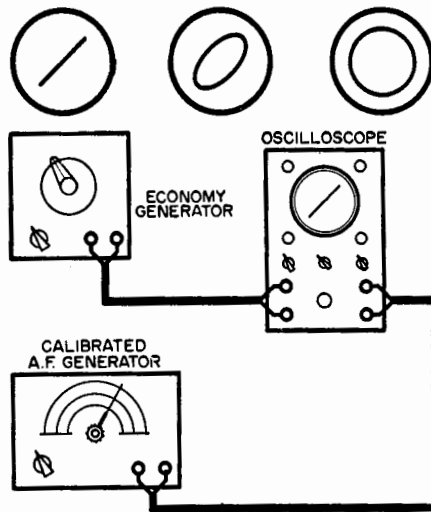

(B)

Fig. 128 (1)—Two possible methods of cali-
brating the audio generator.

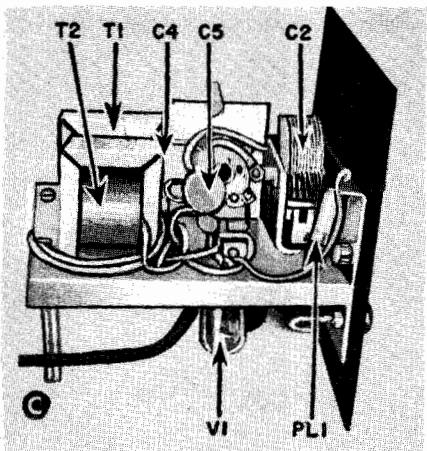
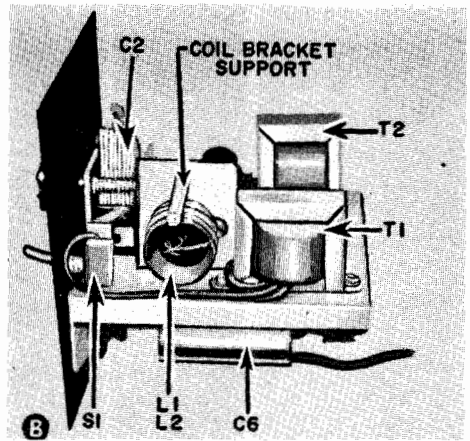
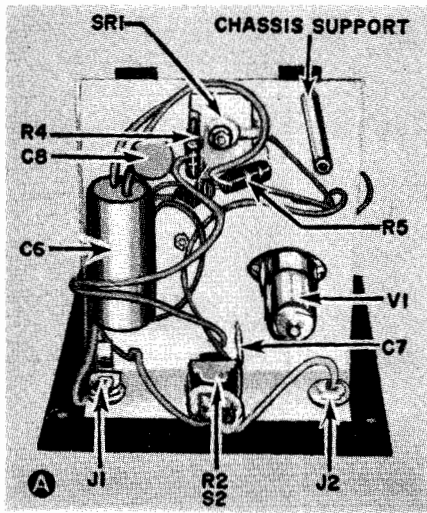

Fig 128 (2)—Three views of the signal generator chassis showing placement of major components: (A) bottom view; (B) right side view; and (C) left side view. Layout is critical.

If you want to maintain the output absolutely constant over the entire frequency range, fixed resistor R1 can be replaced with a 1,000-ohm potentiometer. By adjustment of R1, the output voltage can be regulated. However, readjustment of R1 may produce an unfavorable effect on the output voltage. Therefore, it is recommended that R2 be changed, simultaneously, to a 1,000-ohm potentiometer. Thus, R1 and R2 can be adjusted for an output voltage of approximately 3 volts. The fixed-value resistors R1 and R2 constitute a happy compromise between economics and performance.

It is only necessary to remember that the generator will work into impedances over approximately 1,000 ohms with the attenuator control completely open, i.e., maximum output when you use the generator. It will work into lower impedances if the attenuator control is backed off slightly to introduce some resistance in series with the external load. Of course, this will also reduce the output.

Another characteristic of the circuit, which is true of many RC oscillators, is that if the frequency control is changed suddenly, lamps PL1 and PL2 must adjust to new operating conditions. Because this oscillator has a wide range, it may take a second or two to overcome the thermal inertia of the lamps. This is quite normal in such an oscillator. Operation, otherwise, is straightforward and should present no problem.

R.F. Signal Generator

This radio-frequency signal generator is fairly straightforward in electrical design. Although it uses only one tube, it offers a frequency range that can be spread or tailored to one's individual requirements. This is achieved by the use of plug-in coils. It also results in a general cost reduction . . . particularly because the coil forms are free!

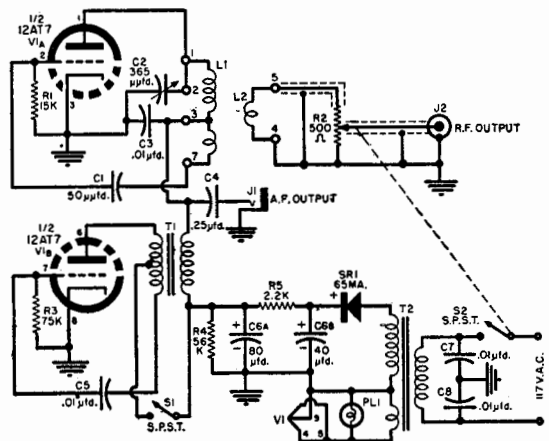

Fig. 129 — Circuit of radio-frequency signal generator.

PARTS LIST

C1—50- μ fd. ceramic capacitor	R3—75,000-ohm, $\frac{1}{2}$ -watt resistor
C2—365- μ fd. variable capacitor	R4—56,000-ohm, 1-watt resistor
C3, C5, C7, C8—0.01- μ fd., 600-volt disc ceramic capacitor	R5—2200-ohm, 2-watt resistor
C4—0.25- μ fd., 400-volt paper capacitor	S1—S.p.s.t. switch
C6—80-40- μ fd., 150-volt electrolytic capacitor	S2—S.p.s.t. switch on R2
J1—Open-circuit jack	SRI—65-ma. selenium rectifier
J2—Coaxial jack	T1—Modulation transformer, 4000-ohm secondary, 10,000-ohm center-tapped primary (Stancor A3812)
PL1—Pilot light	T2—Power transformer, 125 volt @ 15 ma., 6.3 volt @ 0.6 amp. (Stancor PS8415)
R1—15,000-ohm, $\frac{1}{2}$ -watt resistor	V1—Type 12AT7 tube
R2—500-ohm carbon potentiometer	

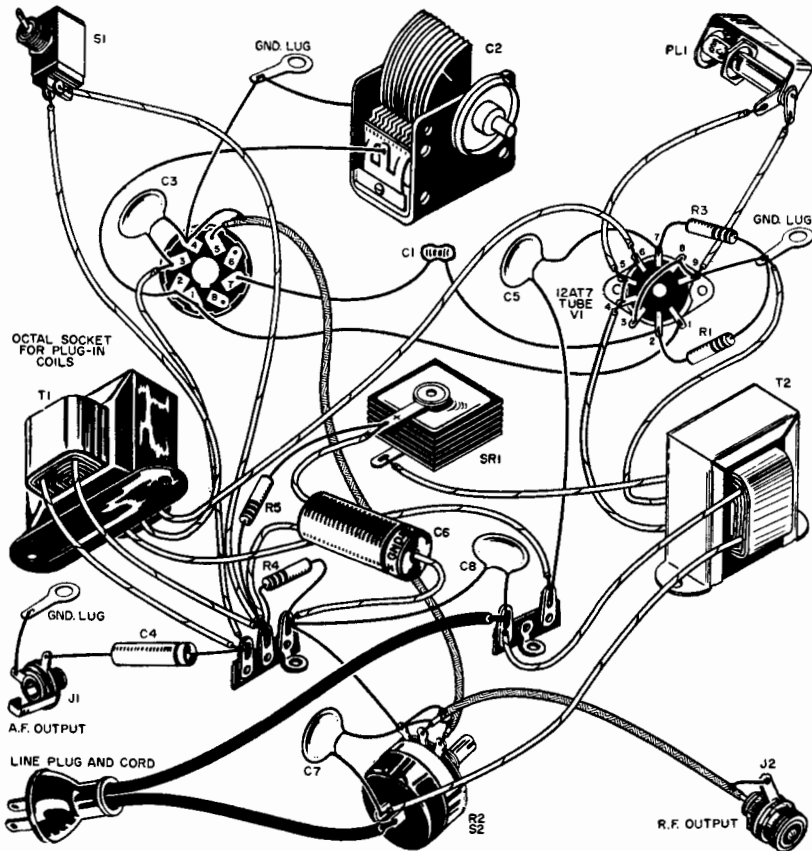

Fig. 130—Pictorial shows how parts of r-f signal generator are interconnected.

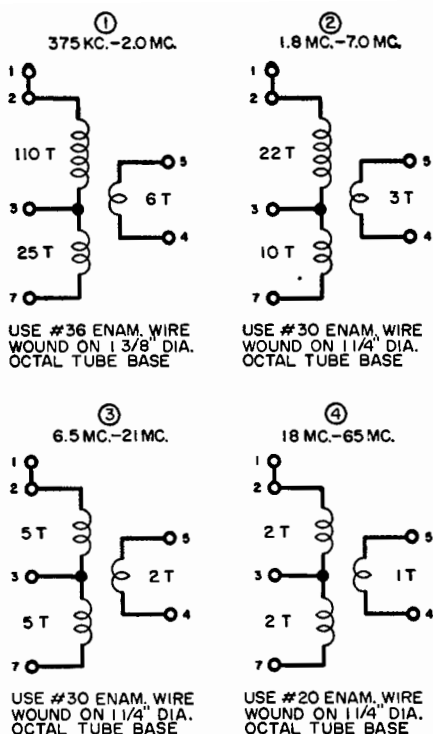

Fig. 131—Four coils required for basic frequency ranges. Use data given here to wind coils.

Four plug-in coils cover the range of 375 kilocycles to 65 megacycles. The generator incorporates an internal 400-cycle audio modulation. The audio tone is made available through the front panel to check audio systems, amplifiers, etc.

Mechanical considerations involved in building a signal generator are as important as the electrical design. Ever try to lift a high-quality laboratory unit? It often takes two men to transport it across a room. Mechanically rugged and rigid construction is a primary aim in these generators.

The "Economy" generator can be lifted by a very small boy, but it has this same philosophy of good mechanical design in its layout. A steel chassis and box are used purely for mechanical rigidity. The rear edge of the chassis has a metal post stand-off, and the plug-in coil bracket has a special metal post to hold it to the cabinet. These precautions make a fairly rugged unit in which the output is reasonably immune to pounding and vibration.

The unit is housed in a black crackle 6-inch by 6-inch by 6-inch steel utility box with a $4\frac{3}{4}$ -inch by $5\frac{1}{2}$ -inch steel shelf. The 12AT7 is mounted vertically under the chassis, and the coil socket is mounted on a right-angle bracket formed from a $1\frac{3}{4}$ -inch by $2\frac{1}{2}$ -inch piece of steel. If short leads are maintained in the coil (L1) and variable capacitor (C2) circuitry, there will be nothing critical in the wiring.

The coil forms can be salvaged from defective octal tubes. Just make sure that the coil is wound on the diameter base specified. Break a tube in a paper bag with a sharp hammer blow. Clean out the base with a pair of cutters. Pick or scrape out the cement with a screwdriver. Remove wires from the pins by heating the pins with a soldering iron. After the solder has melted, give the base a sharp rap, and the hole in the pin will be clear of both wire and solder.

The post providing support between the rear chassis edge and cabinet and the post between the coil socket and cabinet are made up of standard 1-inch threaded metal spacers. They are fastened together by cutting the head off a screw and using the threaded portion to hold the two posts together.

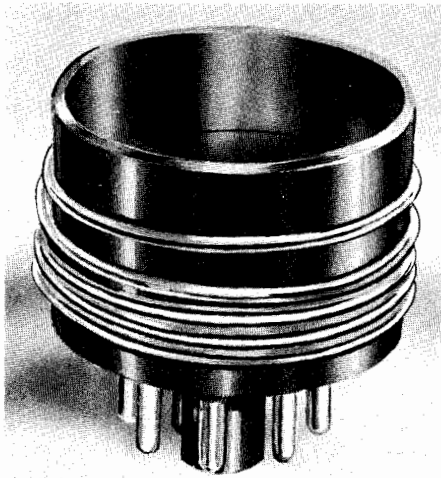

Fig. 132—Coil wound on salvaged octal tube base.

Calibration poses a more interesting challenge than building the generator, but an accurate and reliable calibration can be worked out with a good communications receiver. An “all-wave” receiver can be used if it has a short-wave coverage up to approximately 22 megacycles.

The calibration method described here uses broadcast-band stations of known frequencies. These are made to beat against the generator fundamental and harmonics up through the highest frequency received by the receiver. The lowest frequency of the generator is around 375 kilocycles.

Assume that there is a broadcasting station at 800 kilocycles in your locality and that the receiver is tuned in to this station. Place the receiver antenna close to the generator output lead. If the low-frequency coil is plugged in the unit and the generator is set to the lowest frequency (i.e., the variable plates of C2 are all in), as the generator dial is slowly rotated toward the higher frequencies a beat note or whistle will be heard.

As the dial is rotated, the beat note will first be noticed as a high-pitched whistle which decreases in frequency as the dial is rotated farther. This continues until zero frequency difference is reached. This is known as "zero beat." As the dial is rotated still farther, the frequency will again increase until it is inaudible. However, when the frequency was "zero beat" with the broadcast station at 800 kilocycles, the generator was exactly set to 400 kilocycles. Thus, the first calibration point has been obtained.

The generator frequency is increased until a carrier is heard. This indicates that the generator is set at 800 kilocycles. That point is then calibrated on the generator. With the generator set at 400 kilocycles, previously calibrated, the third and fourth harmonics of the generator can be picked up on the receiver at 1,200 and 1,600 kilocycles. They will be considerably weaker.

After these frequency points have been calibrated on the receiver, more calibrated points on the generator can be determined as follows: Set the receiver to the newly calibrated frequency of 1,200 kilocycles on the dial. Continue to increase the generator frequency until a strong carrier (no whistle) is heard. This frequency will be 1,200 kilocycles, calibrated on the generator dial. Then set the receiver to 1,600 kilocycles. You have determined four frequencies with good accuracy.

With the generator at 1,600 kilocycles, scan the receiver frequencies starting at 1,600 kilocycles for generator harmonic points. The first should be heard at 3.2 megacycles, then 4.8 megacycles, and a weaker one at 6.4 megacycles. Now set the receiver at the 6.4-megacycle spot and double check the lower generator frequencies. For example, as the generator frequency is increased, the next signal heard in the receiver will be that made when the generator is set at 3.2 megacycles. This point is calibrated on the generator dial, and the generator frequency is increased until the carrier is heard at 6.4 megacycles. Such a "bootstrap" process can be repeated to the highest receiver frequency.

The generator frequencies beyond the highest frequency received by the short-wave receiver can be calibrated by using an FM tuner. Because generator harmonics will lie in the FM and TV bands, the procedure described above can also be used to extend the calibration of the generator.

Power Transistor Signal Tracer

With the possible exception of a volt-ohm-milliammeter, signal tracers are perhaps the most useful test instruments in the home workshop. However, a-c.-operated signal tracers have always been handicapped by their sensitivity to 60-cycle pickup. Battery-powered models, using vacuum tubes, have the disadvantages of high-battery drain, tube fragility, and low audio output.

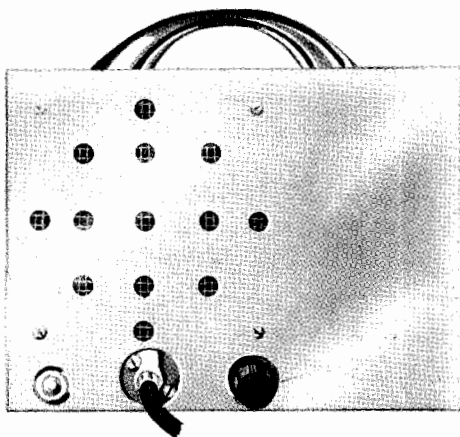

Fig. 133—Transistor signal tracer.

The “deluxe” model tracer shown in Fig. 133 incorporates four transistors and a self-contained 6-volt battery and has almost 1 watt of audio available at the output of the CBS 2N255 power transistor.

Construction is simplified by using a standard aluminum chassis as a cabinet. Cut a small, individual subchassis for parts mounting from a scrap piece of aluminum and bolt it directly on the speaker. Insulate the power transistor from the chassis and then plug it into a 9-prong miniature socket. Solder all other transistors and parts directly into place as the circuit is wired.

Place spaghetti on the collector and base leads of each transistor to prevent shorts to other components or to the chassis. Parts placement is not particularly critical, but try to keep the input components away from the output circuit.

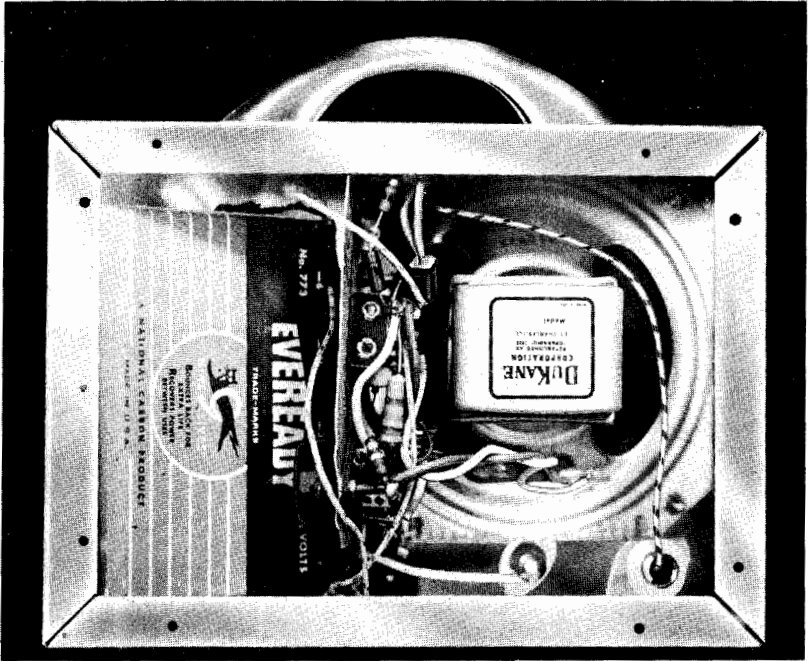

Fig. 134—Internal construction of power transistor tracer.

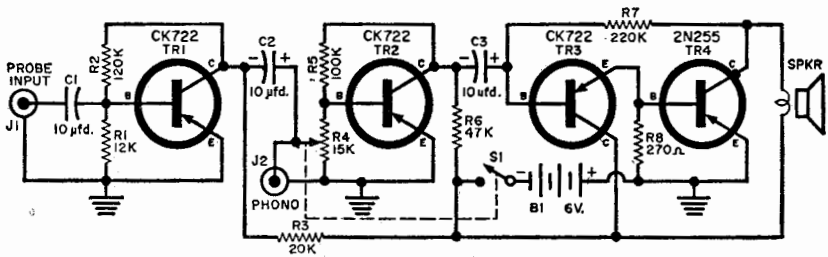

Fig. 135—Circuit of signal tracer uses three CK722's and one 2N255.

Note that this model tracer has two separate input jacks labeled, respectively, "phono" and "probe." The probe jack (j1) is the input for the r.f. detector lead. This probe contains a crystal diode which demodulates the r.f. signal and allows the transistor audio amplifier to build up the signal to audible level.

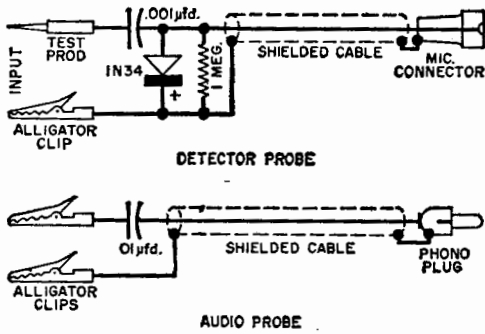

Fig. 136—These special probes should have all elements well shielded. The detector probe components can be built into a small tube shield. All capacitors should be 600-volt miniatures. Thin lapel microphone cable can be used for utmost flexibility.

When testing in audio stages where less gain is required, use the phono jack input. This jack (j2) is fed by a shielded cable terminated on one end by a standard type phono plug and on the other by an isolating capacitor. For audio applications, such as crystal phono cartridge testing or hi-fi amplifier servicing, this input is best.

Using the tracer for trouble shooting is simplicity itself. Turn the radio receiver on and tune it to a strong local station. Connect the signal tracer's ground lead to the receiver's chassis or "ground." Then turn the signal tracer on, adjusting gain control R4 for full volume. Starting at the receiver's antenna, touch the probe to the "input" and "output" of each stage to check individual stage operation. If the program is heard at one stage but not at another, check the circuit between them. Defective radios, hi-fi amplifiers, p.a. systems, TV receivers, and intercom circuits should present no problems for this little, transistorized signal tracer.

9 PROJECTS YOU CAN BUILD

THE PROJECTS in this chapter have been selected as units sure to work when properly constructed. They require varying degrees of building skill—the beginner may find some that will give him practice; the more advanced worker may find some that challenge his electronic skills. Amplifiers and AM radios are generally easy projects with which to start. Do not work with miniaturized transistor equipment until you have developed sufficient skill with a soldering iron to work in tight places.

Low-cost Broadcast Receiver

All of the parts for this simple, two-tube receiver are probably available in the junk box of an average radio experimenter.

Coil L1 is a Feri-Loopstick. Tuning capacitor C2 can be any high-capacity variable salvaged from a junked AM receiver. Filament-dropping resistor R7 can be a single 500-ohm, 20-watt resistor or a pair of 10-watt, 1,000-ohm resistors in parallel.

The circuit uses a 12AT7 (V1) as a detector and audio amplifier, and a 35W4 serves as a half-wave rectifier. Although the grid leak detection method may add some distortion in very strong signal areas, the sensitivity is much greater than that obtained with crystal diode detectors.

Remember that this is an a.c./d.c. receiver and that care must be exercised in grounding the chassis. Keep the chassis away from water pipes and outside electrical grounds.

The antenna can be any length of wire. Using only 6 feet of antenna, stations 500 miles away were pulled in at night. The local stations were quite strong during the daytime.

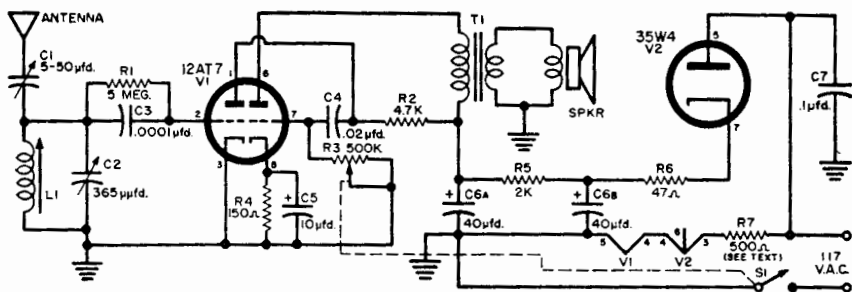

Fig. 137—Schematic for low-cost receiver. A 12AU7 can be used in place of the 12AT7 if it is easier to obtain.

After the antenna is connected, tune in a very weak station near the minimum capacity of tuning capacitor C2. Then adjust the core in the Feri-Loopstick for maximum volume.

PARTS LIST

C1—5-50- μ fd. variable capacitor	R4—150-ohm, $\frac{1}{2}$ -watt carbon resistor
C2—365- μ fd. variable capacitor	R5—2000-ohm, 1-watt carbon resistor
C3—0.0001- μ fd. mica capacitor	R6—47-ohm, 1-watt carbon resistor
C4—0.02- μ fd., 400-volt paper capacitor	R7—500-ohm, 15-20 watt wire-wound resistor
C5—10- μ fd., 25-volt electrolytic capacitor	S1—S.p.s.t. switch (on R3)
C6a/C6b—40-40 μ fd., 150-volt electrolytic capacitor	SPKR—PM speaker
C7—0.1- μ fd., 400-volt paper capacitor	T1—Output transformer, 4000-ohm primary, 3.5-ohm secondary
L1—Feri-Loopstick	V1—12AT7 tube
R1—5-megohm, $\frac{1}{4}$ -watt carbon resistor	V2—35W4 tube
R2—4700-ohm, $\frac{1}{2}$ -watt carbon resistor	
R3—500,000-ohm volume control potentiometer	

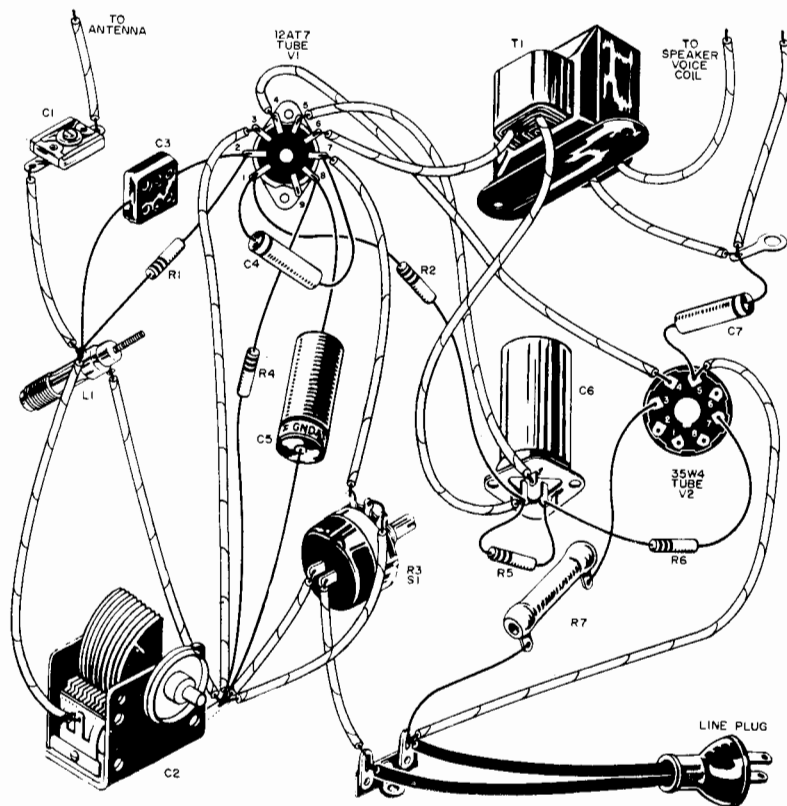

Fig. 138—Interconnect components as shown. Resistor R7 will get warm in normal operation.

One-tube Hi-Fi AM Tuner

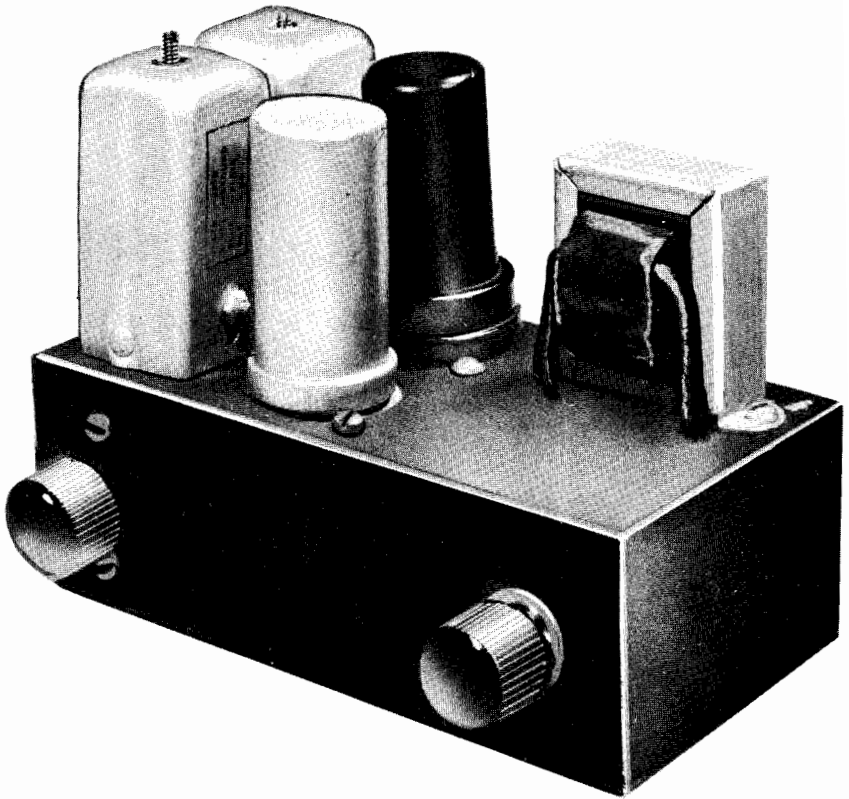

Fig. 139—Compact AM tuner can be used for stereo channel in AM/FM stereo setup.

This unusually compact, inexpensive broadcast-band AM radio tuner is useful for the AM channel of AM/FM stereo listening. As a solo performer, it will bring new life into AM broadcasts played through your hi-fi rig.

Completely self-contained, and with its own transformer-type a.c. power supply, the unit has as wide a frequency response as AM stations transmit. It introduces no distortion in its detector stage and uses so little power that you can expect operation for many years without trouble or breakdown. A stage of r.f. amplification and the two tuned stages of iron-core high-Q coils cover the whole broadcast band with sensitivity and selectivity.

The entire tuner is constructed on a $5\frac{1}{4}$ -inch by 3-inch by $2\frac{1}{8}$ -inch chassis. Needless to say, the cost of this "one-evening project" is quite low.

An old standard, the 6SK7 tube, is used as an r.f. amplifier and is paired with a 1N34A or CK705 as a tuned diode detector. A selenium rectifier eliminates the need for a tube in the power supply.

Antenna length is not critical—use a long enough wire to give adequate audio signal output. A volume control with an on-off switch is shown in the photos and diagrams; this can be eliminated if the high-fidelity amplifier to which the tuner is connected already has one.

PARTS LIST

C1—0.005- μ fd., 600-volt capacitor	R3—1000-ohm, 1-watt resistor
C2a/C2b—365-365 μ fd., 2-gang, TRF-type tuning capacitor	R4—100-ohm, $\frac{1}{2}$ -watt resistor
C3—0.01- μ fd., 400-volt capacitor	S1—S.p.s.t. switch (on R2)
C4—250- μ fd. mica or ceramic capacitor	SR1—20-ma., 130-volt selenium rectifier
C5—0.01-200-volt capacitor	T1—Antenna coil (Miller A-320-A)
C6a/C6b—20-20 μ fd., 150-volt dual electrolytic capacitor	T2—Detector coil (Miller A-320-RF)
CR1—1N34A or CK705 germanium oxide	T3—Power transformer, 117-volt primary, 125 volts @ 15 ma. secondary, and 6.3-volt, 0.6-amp. filament winding (Stancor PS8415)
R1—330-ohm, $\frac{1}{2}$ -watt resistor	V1—6SK7 tube
R2—500,000-ohm potentiometer	

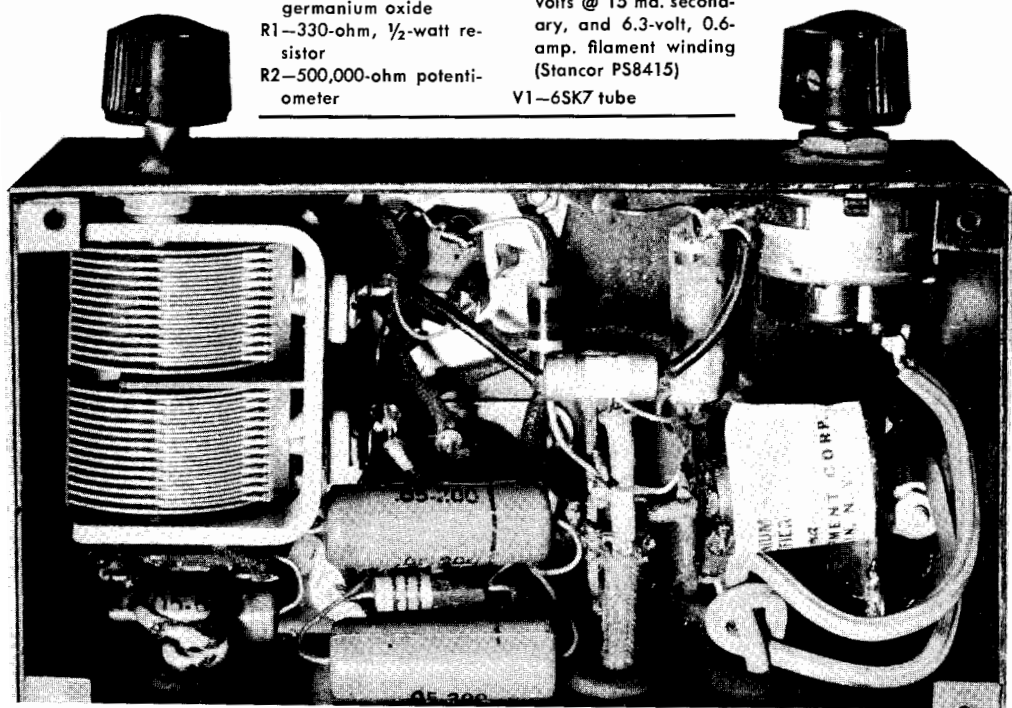

Fig. 140—Under-chassis view of the completed tuner shows parts placement.

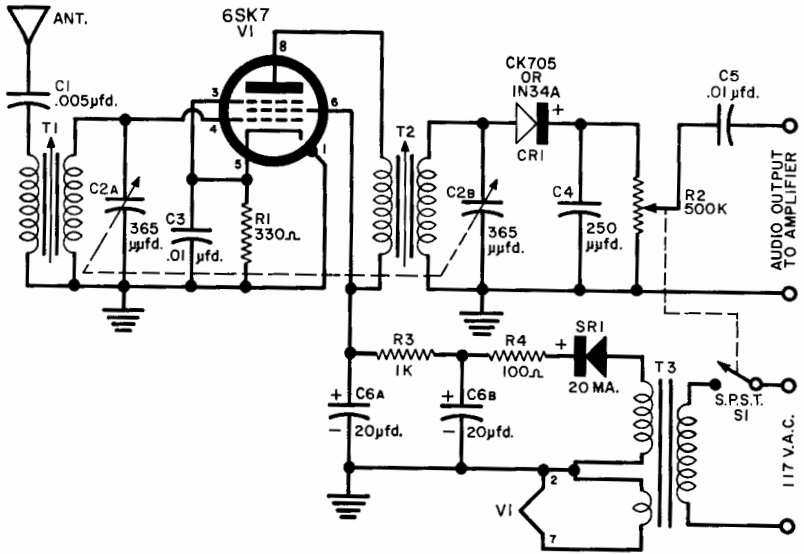

Fig. 141—Note the use of the power transformer to connect the tuner to any amplifier.

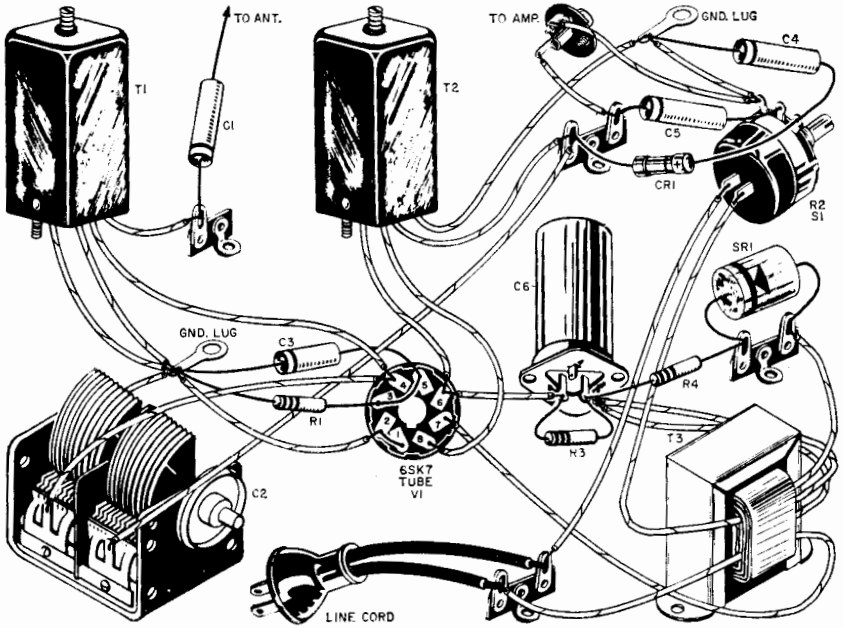

Fig. 142—Follow the pictorial diagram for best results in building the tuner.

V.H.F. Explorer's Receiver

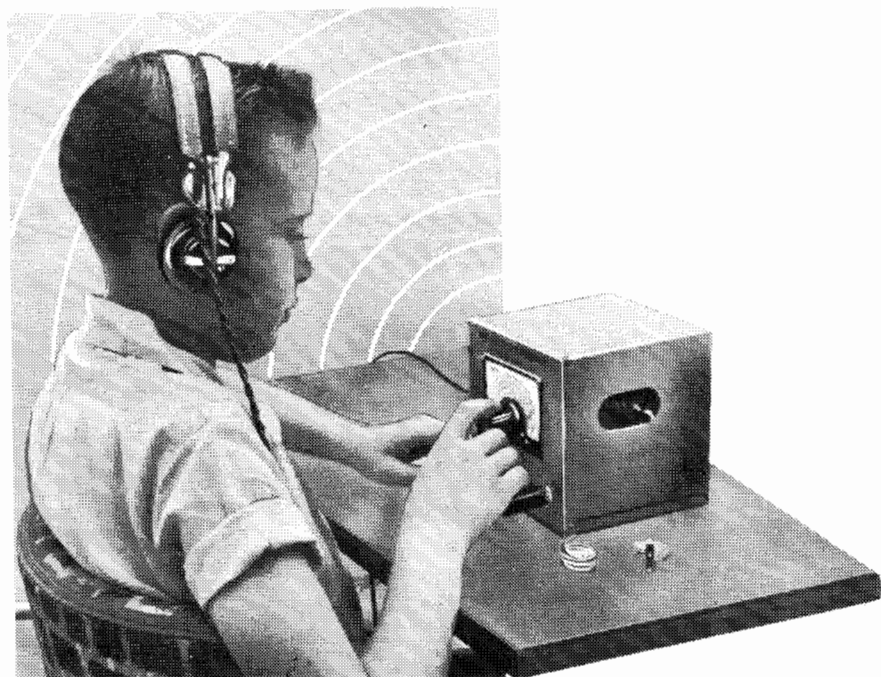

Fig. 143—You can tune in on many new listening pleasures with the v.h.f. explorer's receiver.

Exploring the many services using the v.h.f. band will furnish you with real listening excitement. Not only are the familiar FM and TV broadcasting services found in this region, but there are also a host of others, such as: Police, Fire, Public Utilities, Taxi, Aircraft, Amateur, etc.

The Explorer's Receiver has three plug-in coils and will pick up all these services in the range of 28 to 175 megacycles. The receiver has excellent sensitivity, although it uses only two tubes. This is accomplished by using a superregenerative detector. This detector circuit has long been famous for its sensitivity, as well as for some of its less desirable traits. A superregenerative detector is basically an oscillator. Therefore, it's only natural that it cause interference. In this receiver the problem is overcome by preceding the detector with an r.f. isolation stage.

PARTS LIST

- C1—0.001- μ fd. tubular ceramic capacitor
C2a/C2b/C2c—20/40/20 μ fd., 250-volt electrolytic capacitor (Cornell-Dubilier Type BBRT 4225C)
C3—7- μ fd. tubular ceramic capacitor
C4—0.33- μ fd., 200-volt paper capacitor
C5—3.0- μ fd. to 22.5- μ fd. v.h.f. capacitor (National Type VHF-I-S)
C6—0.004- μ fd. tubular ceramic capacitor
C7—25- μ fd. tubular ceramic capacitor
C8—0.01- μ fd. disc ceramic capacitor
J1—Open-circuit jack
L1—3 coils
R1, R3—330-ohm, $\frac{1}{2}$ -watt resistor
R2—5600-ohm, 1-watt resistor
R4—47,000-ohm, $\frac{1}{2}$ -watt resistor
R5—7.5-megohm, $\frac{1}{2}$ -watt resistor
R6—25,000-ohm potentiometer
R7—2200-ohm, 2-watt resistor
RFC1, RFC2—Z50 Ohmite choke
RFC3—25-mh. choke
RFC4, RFC5—Z144 Ohmite choke
S1—S.p.s.t. toggle switch
SR1—65-ma., 160-volt selenium rectifier
T1—Power transformer, sec. 150 volt, 25 ma., 6.3 volt @ 0.5 amp. (Stancor P8181)
T2—Audio transformer, interstage 1:3 ratio (Stancor A-53)
V1—12AT7 tube
V2—6AF4 tube
1—Crystal socket (Miller No. 33102)
1—6" x 6" x 6" cabinet (LMB)

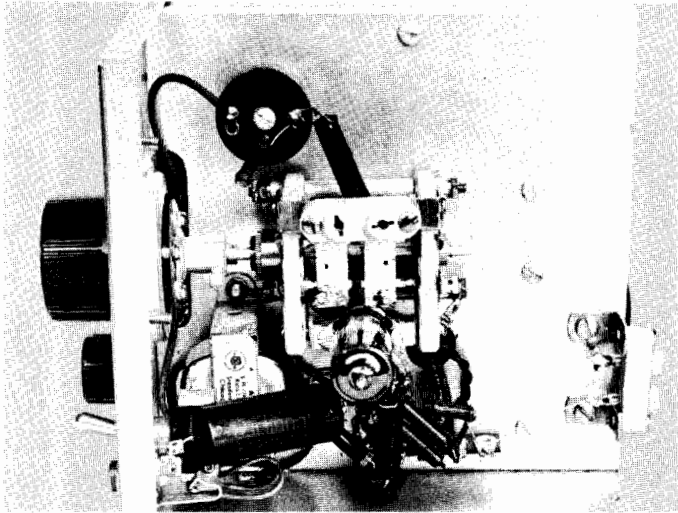

Fig. 144—Interior view of left side of the receiver showing location of power-supply components and the combination r.f. and audio-amplifier tube.

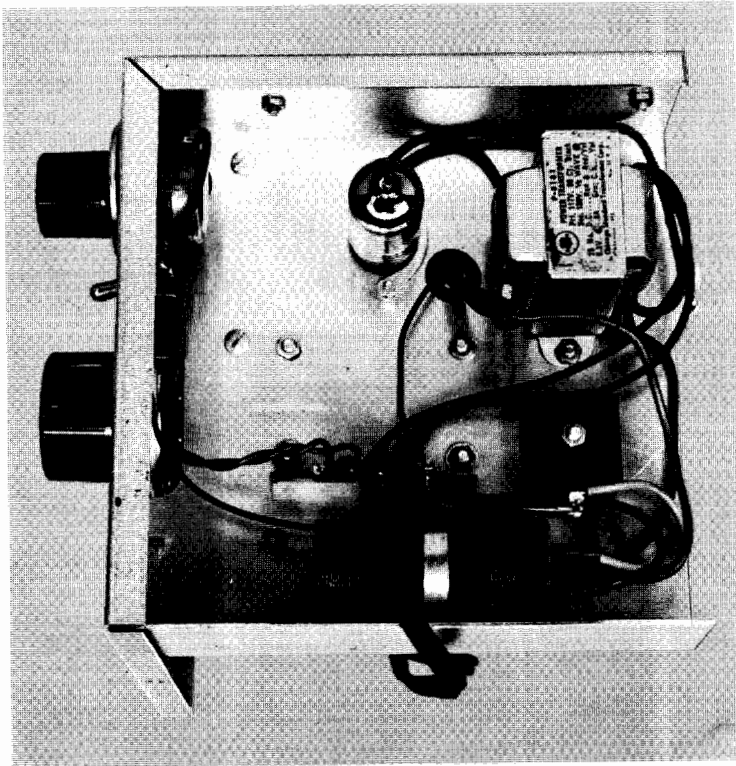

Fig. 145—Right side of receiver contains oscillator tube and coil socket into which band coils are plugged. Point-to-point wiring and short leads are used.

This receiver requires some care in building. The lengths of the leads play an important part in successful operation. For this reason, it is recommended that the photographs of the receiver be carefully studied. If possible, copy the parts layout exactly.

The receiver itself is constructed in a 6-inch by 6-inch by 6-inch box in which the chassis is mounted vertically. There is a good reason for this unorthodox approach. It permits very short leads between the antenna input and the detector. Note that the r.f. stage is mounted horizontally from one side of the chassis so that the bottom of the socket will face the 6AF4 socket.

The detector tube socket is mounted on the variable capacitor C5, which is made specifically for this application and has brackets for mounting a tube socket. The coil socket is a ceramic (or other high-quality material) crystal socket. All sockets, couplings, and capacitors used in the r.f. and detector stages should be of similar high-quality material.

Fig. 146 (1)—For the 28-50-mc band: six turns of Barker & Williamson Miniductor No. 3015 coil stock (16 turns/inch), soldered into Millen No. 37412 plug. (2)—For the 48 to 90-mc band: four turns of No. 12 wire, tinned, $\frac{1}{2}$ " long, 1" in diameter. (3)—For the 90-175-mc band: two turns of No. 12 wire, tinned, $\frac{1}{2}$ " long, $\frac{3}{4}$ " in diameter.

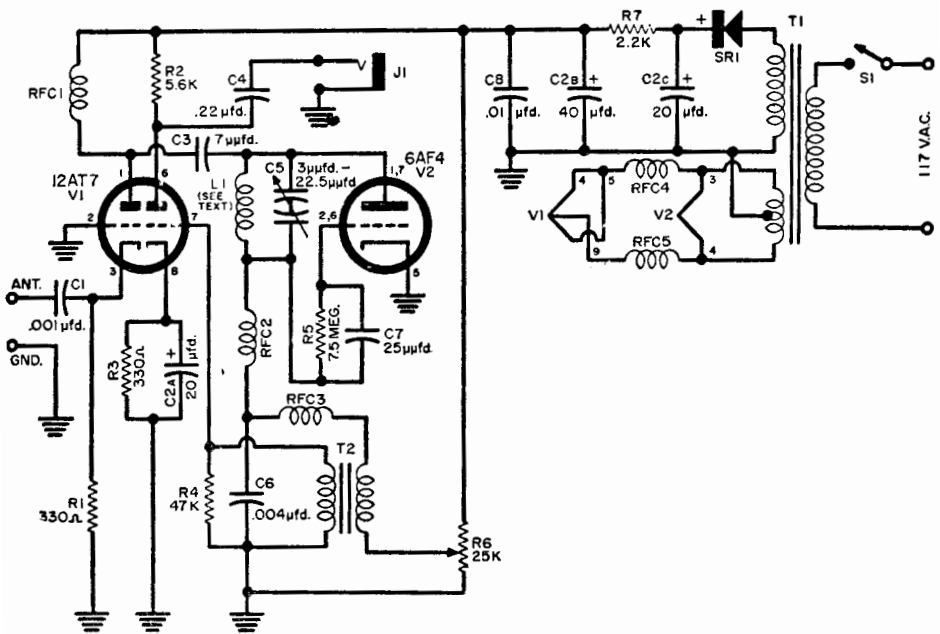
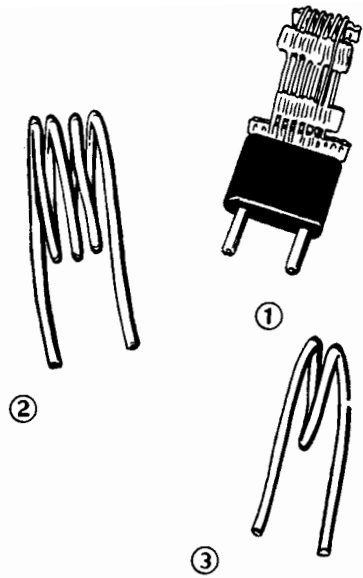

Fig. 147—Schematic for v.h.f. receiver.

The National VHF-1-S tuning capacitor C5 is different from the type of variable capacitor commonly used at lower frequencies. There are two stators and two rotors, but the capacitor wiring terminals are connected to the two stators while the rotors are fastened to a common shaft. Thus, two variable capacitors are effectively placed in series.

The power supply section is located on the chassis opposite the r.f. wiring.

Before the unit is assembled, the cabinet will need a large hole cut through the side to comfortably allow the plugging in of the three coils. The hole in the model shown is $1\frac{1}{4}$ inches by $2\frac{3}{8}$ inches.

After the receiver is completed, including the coils, turn on the a.c. switch, and advance the regeneration control R6 until a loud hissing sound is heard in the headphones. Now tune the receiver for a signal—always remember to adjust the regenerative control for the proper level.

The last step is to calibrate the three bands. If you have access to a signal generator, this is no problem. It becomes more difficult, but not insurmountable, if no signal generator is available. Generally there are enough signals of known frequency, such as TV and FM stations, to allow you to make a rough calibration.

There is no single antenna that will produce top performance over the complete range covered by the receiver. An outdoor TV antenna will perform fairly well. However, this type of antenna is directional and horizontally polarized. Most mobile services use vertically polarized antennas. For general listening, a plain random-length piece of wire does as well as anything.

For top performance, a dipole cut to the desired frequency will produce superior results. The antenna can then be hung vertically or horizontally.

Printed-circuit Transistor Receiver

With a power consumption of about 1 milliwatt, and using the new miniature dynamic earphones, this receiver will deliver earsplitting volume on local stations. A little more than half the size of a king-size pack of cigarettes, its power supply is a single 1.3-volt mercury cell which is called on to supply about 1 milliampere of current at full volume. It needs no external antenna, although one can be employed in low-signal areas.

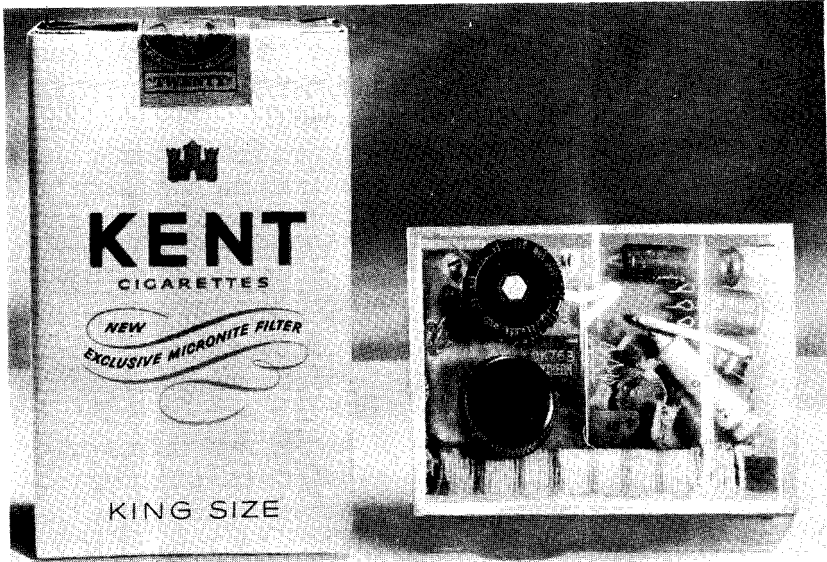

Fig. 148—Complete transistorized receiver.

PARTS LIST

- | | |
|--|---|
| B1—1.3-volt mercury cell (Mallory RM-630) | $1\frac{1}{16}'' \times 2\frac{5}{16}''$ for PC2) |
| C1—365- μ fd., single-gang, midget variable capacitor (Argonne Poly-Vari-Con) | R1—100,000-ohm resistor, $\frac{1}{2}$ -watt resistor |
| C2, C5—0.01 μ fd., subminiature capacitor (Aerovox P832) | R2—15,000-ohm, $\frac{1}{2}$ -watt resistor |
| C3—0.0005 μ fd., subminiature capacitor (Centralab DM-501) | R3—5600-ohm, $\frac{1}{2}$ -watt resistor |
| C4—30- μ fd., 6-volt electrolytic capacitor | R4—25,000-ohm subminiature volume-generation potentiometer (Lafayette VC-45) |
| C6, C7, C8—8- μ fd., 6-volt electrolytic capacitor | R5, R6—22,000-ohm, $\frac{1}{2}$ -watt resistor |
| J1—Miniature jack (Telex 9240) | S1—S.p.s.t. switch (on R4) |
| L1—50 turns of #22 s.c.e. wire on $\frac{1}{4}'' \times 2\frac{3}{8}''$ ferrite core (Lafayette MS-331)—see text | TR1—CK768 transistor |
| L2—Six turns #22 s.c.e. wire on same core | TR2, TR3, TR4—CK722 transistor |
| L3—R.f. choke (winding from a discarded miniature i.f. transformer) | 1—6-oz. bottle of etching solution (Lafayette PE3) |
| PC1, PC2—XXXP printed-circuit copper laminated board (one $2'' \times 4\frac{1}{4}''$ section cut in two parts— $1\frac{1}{16}'' \times 2\frac{7}{16}''$ for PC1 and | 1—Roll of resist-tape or ball-point tube (Lafayette PRT-3 or PRTL) |
| | 12—"Flea" clips for soldering contacts |
| | Misc. eyelets (0.062" in diameter by 0.093" long); tin, copper or brass for battery holder; plastic cabinet |

Two printed-circuit boards (PC1 and PC2) are used (see parts list). Cut out the laminate to sizes shown in templates in Fig. 149. These can be made as described in Chapter 5. The width of the conductor strips should be about $\frac{1}{16}$ inch, and the connection points should be about $\frac{1}{8}$ inch in diameter.

Drill the holes for mounting the components. All are made with a $\frac{1}{16}$ -inch drill, except the mounting holes for the tuning capacitor (C1). Two of these holes are $\frac{1}{8}$ inch in diameter and are countersunk from

the nonetched side of the board. The hole for the shaft of the same capacitor is $\frac{1}{4}$ inch in diameter and is countersunk from the etched side of the board. Although the flea clips are intended to be mounted in $\frac{3}{32}$ -inch holes, it is better if only the smaller bottom part is fitted into the $\frac{1}{16}$ -inch holes.

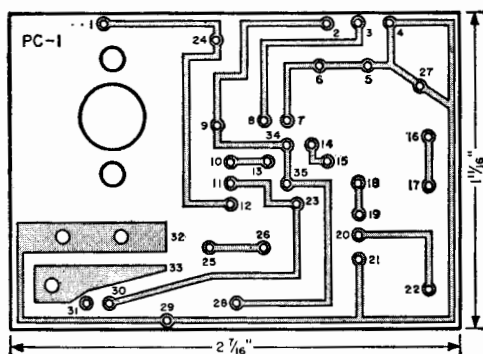

Fig. 149-a

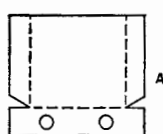
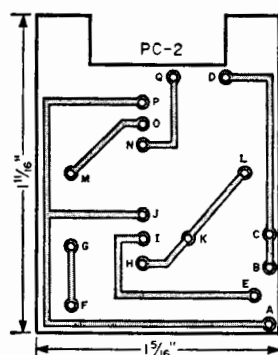

Fig. 149-b



CONNECTIONS FOR PC1

1—Top of antenna coil	24—C1 (bottom terminal)
2—Bottom of antenna coil	25 and 31—R1
3—Top of tickler coil	25 and 35—R2
4—Bottom of tickler coil	25—Wire to PC2, Point B
5 and 15—R3	26—S1 (either terminal)
6 and 14—C5	27—C4 (pos. terminal)
7 and 34—C2	28—C6 (neg. terminal)
8 and 13—C3	29—Wire to PC2, Point A
9—Top terminal of C1	29—Right terminal of R4 (with prongs facing you)
10—Emitter of TR1	30—R4 (center terminal)
11—Base of TR1	31—Left terminal of R4 (with prongs facing you)
12—Collector of TR1	32—Positive terminal of battery holder (Part A) — see text
13 and 15—L3	33—Negative terminal of battery holder (Part B) — see text
16 and 18—R5	33—S1 (remaining terminal)
17 and 26—Jumper wire	
18—2" wire to G of PC2	
19—Collector of TR2	
20—Base of TR2	
21—Emitter of TR2	
22—C6 (pos. terminal)	
23—C4 (neg. terminal)	

CONNECTIONS FOR PC2

A—Wire from 29 of PC1
B—Wire from 25 of PC1
C and K—R6
D—Wire to one terminal of J1
E—C7 (pos. terminal)
F—C7 (neg. terminal)
G—Wire from 18 of PC1
H—Collector of TR3
I—Base of TR3
J—Emitter of TR3
L—C8 (neg. terminal)
M—C8 (pos. terminal)
N—Collector of TR4
O—Base of TR4
P—Emitter of TR4
Q—Remaining terminal of J1

Follow the lists of connections (two numbers or letters indicate that a component should be connected between these two points, and a single letter designates a terminal such as one of the transistor electrodes or a battery terminal) and insert all the components in their respective positions, but do not solder them in as you go along. They are all mounted on the nonetched side of the board with the exception of C1, R1, and the battery holder.

If all parts fit well, solder them in place with a hot, well-tinned, small-tip soldering iron or gun. When soldering the parts in place, always have the transistors in place when soldering the flea clips to the conductors.

Antenna coil L1 is wound on a piece of ferrite core which measures $2\frac{3}{8}$ inches by $\frac{1}{4}$ inch in diameter. This coil consists of fifty turns of No. 22 single cotton enamel wire, and the tickler coil (L2) is made from six turns of the same kind of wire. Wind both coils immediately adjacent to each other and in the same direction; otherwise you will not get positive feedback and the detector will not oscillate.

The battery holder consists of two parts: Part A, the positive terminal, connected at 32; and part B, the negative terminal, connected at 33. Trace the pattern of these parts as shown in Fig. 149 on brass, tin, or copper; then cut them out. Bend them on the dotted line toward you while you hold the parts as shown. Mounting holes for the battery holder are also $\frac{1}{16}$ inch in diameter, and terminals are riveted to the board using small eyelets or miniature screws and bolts.

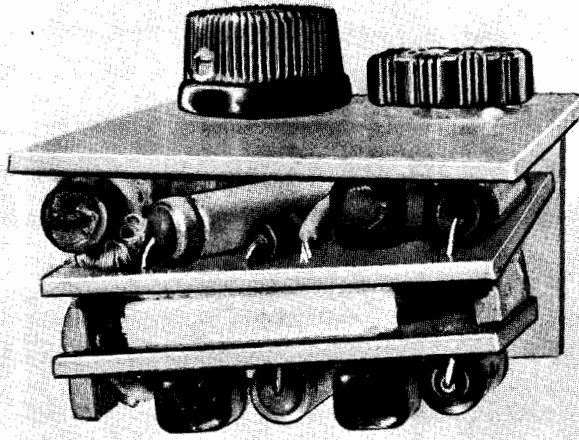

Fig. 150—Side view of the completed assembly. Note the small wooden spacers glued between the two printed-circuit chassis boards. The three sides and the bottom of the chassis are installed later.

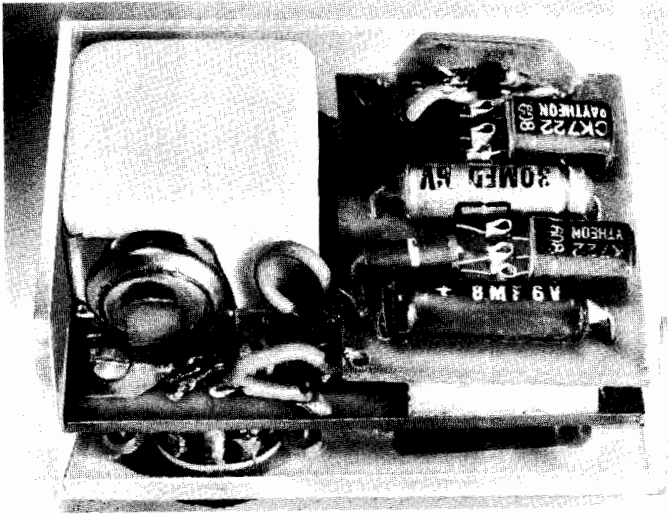

Fig. 151—Chassis with two sides installed. Tuning capacitor and battery are at left.

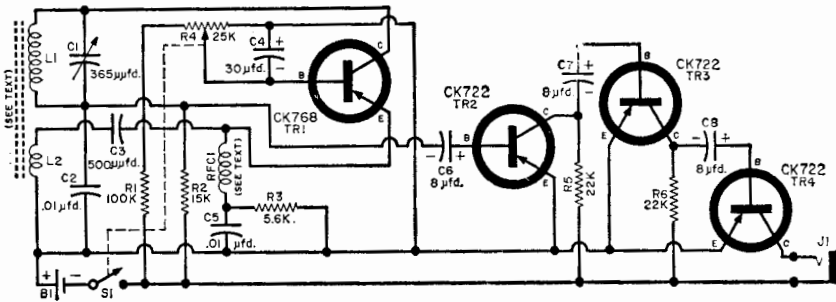

Fig. 152—Schematic diagram of transistorized receiver.

Pieces needed to construct a cabinet can be cut from a clear polystyrene sheet. The front and back of the case shown measures 1 $\frac{7}{8}$ inches by 2 $\frac{5}{8}$ inches; the top and bottom are 1 inch by 2 $\frac{5}{8}$ inches; and the sides measure 1 inch by 1 $\frac{3}{4}$ inches. Glue the pieces together temporarily, but leave the back off.

Place the completed receiver inside the case and mark the spots for the shaft of C1 and the regeneration control (R4). Drill a $\frac{1}{4}$ -inch-diameter hole for the shaft and starting hole of R4. With a $\frac{5}{8}$ -inch chassis punch, score a $\frac{5}{8}$ -inch circle in the plastic. Cut out the circle with a jigsaw. Fasten the potentiometer to the panel through the on-off switch tabs.

The box can now be cemented together. Place the radio inside and drill the mounting holes for R4 and earphone jack J1.

Listen to Aircraft with a Miniature v.h.f. Receiver

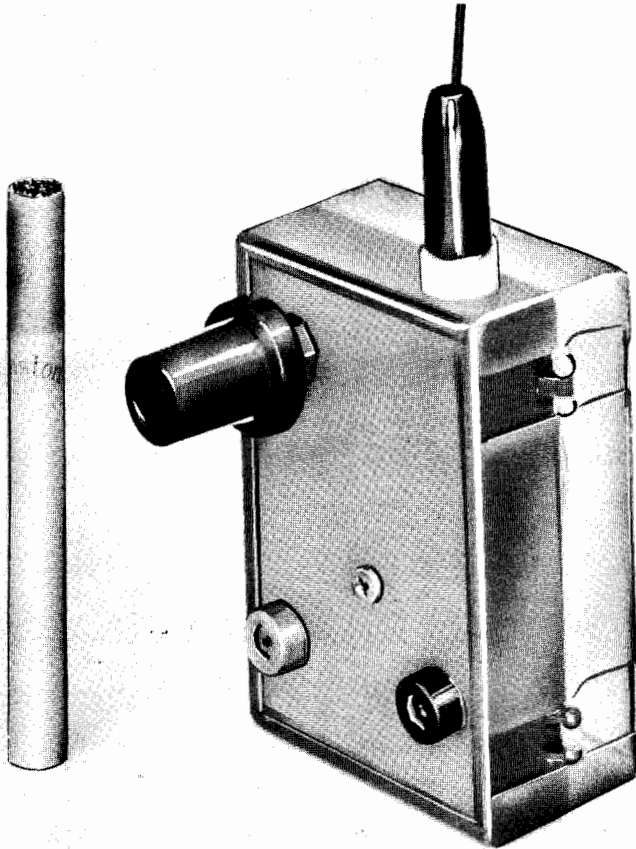

Fig. 153—Aircraft receiver is no higher than a cigarette.

If you live near an airport, you can use this receiver to listen in on the control tower talking to aircraft. If you take a flight, you can listen to aircraft talking to the ground control station. You can do all this with the receiver operating in your pocket.

The unit that performs these stunts is shown in the photographs. It employs a 1N82 v.h.f. silicon crystal diode detector and uses an inexpensive CK722 transistor for an audio amplifier. The transistor is powered by one or two 1½-volt penlite batteries.

You can build the v.h.f. receiver in a plastic box measuring approximately 2 inches by 2⅞ inches by 1 inch (obtainable from a local

PARTS LIST

- B1—Penlite cell
- C1—9- μ fd. variable capacitor (Johnson 9M11)
- CR1—1N82 v.h.f. diode
- J1—Tip plug and jack
- J2, J3—Tip jack
- L1—4 turns of #16 tinned wire, $\frac{3}{4}$ " diameter, spaced to $\frac{1}{2}$ " long
- TR1—CK722 transistor (Raytheon)
- TR2—2N35 transistor (optional—see text)
- 1—2" x 2 $\frac{7}{8}$ " x 1" plastic case
- 1—Phenolic tie point (Cinch-Jones 53E)
- 1—Knob, $\frac{3}{16}$ " shaft
- 1—16" length of stiff copper wire for antenna

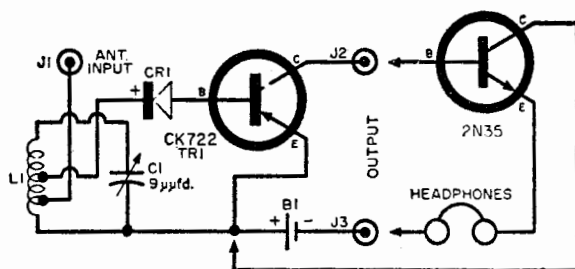

Fig. 154—Schematic diagram of receiver. Headphones can be plugged directly into output of single transistor, but greater volume results if transistor TR2 is added and J2/J3 repositioned in circuit.

five-and-ten-cent store). A banana jack atop the box holds a 16-inch length of wire to be used as an antenna. On the front of the box is a tuning capacitor, C1; this is an ordinary 9-micromicrofarad midget capacitor.

At the bottom of the plastic box, the penlite cell(s) is held in place by two short pieces of solid wire, soldered to the ends of the battery. The negative (battery shell) lead goes directly to the earphone jack above the battery; the positive lead goes to the transistor's emitter terminal. The collector of the transistor is distinguished by a red dot on the case. This terminal of the tie-point strip is connected to the other earphone pin-tip jack.

Wind a simple four-turn coil of No. 16 tinned wire and mount it across the terminals of C1. The coil is tapped one-half turn up from the end attached to the rotor of C1 and is connected to the emitter of TR1 by another length of short wire.

The last item to be placed in the circuit is the 1N82 v.h.f. diode. This connects between the base of the transistor and a tap on the

tuning coil. Place the tap two turns up from the end of the coil attached to the rotor of C1.

As in the case of the transistor, the IN82 crystal can be damaged by excessive heat. As you solder each into the circuit, hold the wire between the crystal and the solder junction with long-nose pliers. The crystal should be so oriented in the circuit that the terminal with the arrowhead is attached to the tie point.

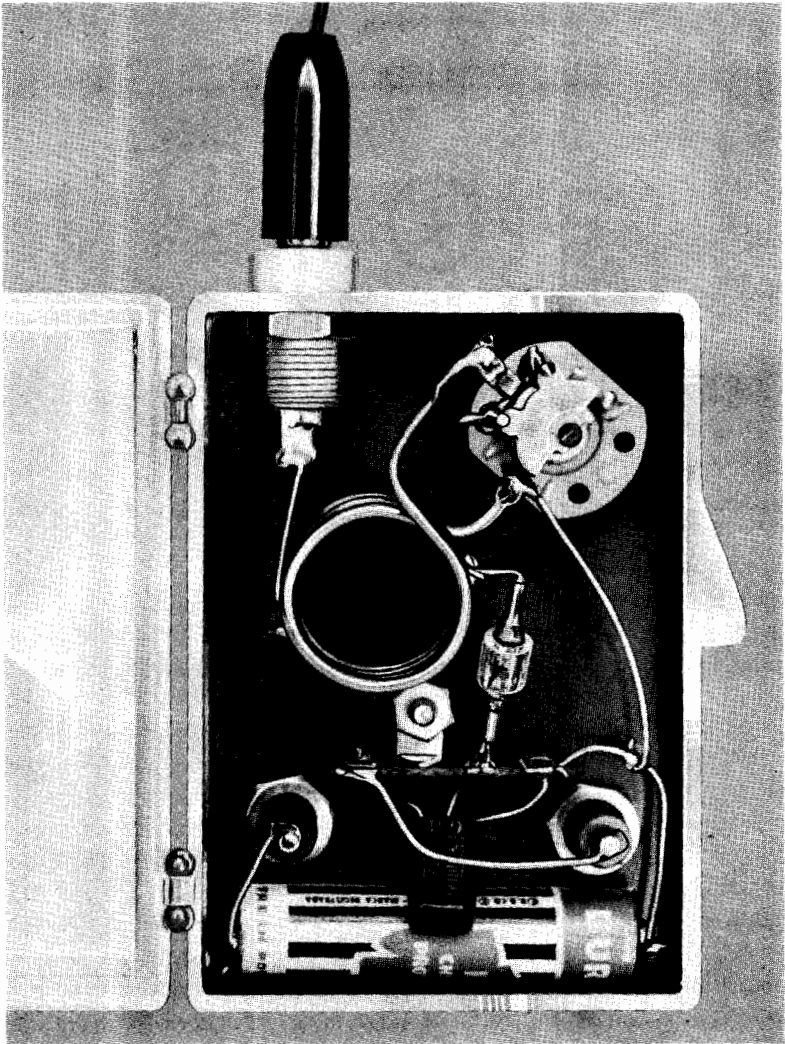

Fig. 155—Parts placement can be seen from inside photo of finished unit.

This receiver can be made in two versions. Addition of the second transistor (the NPN 2N35, TR2) will increase the volume. This is particularly important if you want to use this receiver in a noisy area or with a very high impedance earphone. If your earphone has a d.c. resistance of between 1,000 and 1,500 ohms, the simple circuit with the single transistor will probably work very well. A 2,000-ohm headset requires the additional transistor and an increased battery voltage (3 volts).

After the receiver is completed, it can be tested by bringing coil L1 near a grid-dip oscillator tuned to the vicinity of 100 megacycles. If an antenna is attached to the GDO and the GDO is modulated with a tone, it should be possible to receive the signal 10 or 15 feet away.

Don't expect the signals to blast your ears. The sensitivity is very low. A good check for sensitivity and operation is to listen in near a running automobile. If the sensitivity is what it should be, you should hear the popping and snapping of the car's ignition.

Using the model at the local airport, the control transmitter should be heard several hundred feet from the tower, and the approaching planes should be heard as they come in for a landing.

Two-tube Economy Amplifier

This is a simple, low-cost amplifier that can be used with a crystal pickup or FM tuner. Although the circuit contains only two tubes, there is ample output for both of these applications. Utilizing dual-purpose tubes (a 6SL7 for two amplifying stages and a 117N7 as a rectifier and beam output tube) its performance is equal to that of a three- or four-tube unit.

A tapped tone control boosts either the bass or the treble ranges and can be used to equalize older recordings. Fidelity-wise, there are three applications of inverse feedback to make it nearly distortion free. But naturally, the 117N7 tube with its 1-watt output cannot be expected to rival a 40-watt "monster."

In place of a "hot" chassis, which is found in most small amplifiers of the a.c./d.c. variety, all circuit grounds terminate at a single lug which is chassis-grounded through capacitor C2.

Voltage for the two tube filaments is obtained from two different sources. The 117N7 tube (V2) works right across the 117-volt a.c. line without a dropping resistor. A 290-ohm resistor line cord is used to obtain the necessary voltage for the 6SL7 (V1).

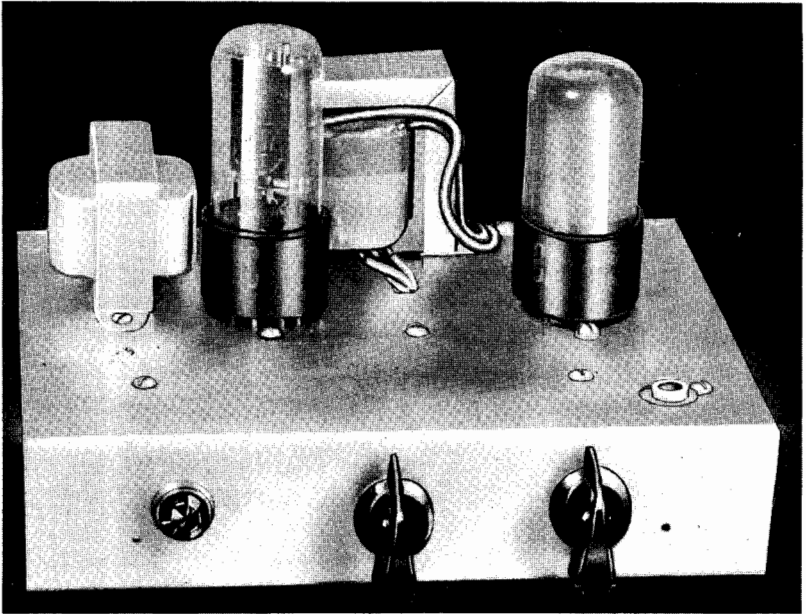

Fig. 156—Two-tube power amplifier. Pilot light, tone control, and volume control are on front panel.

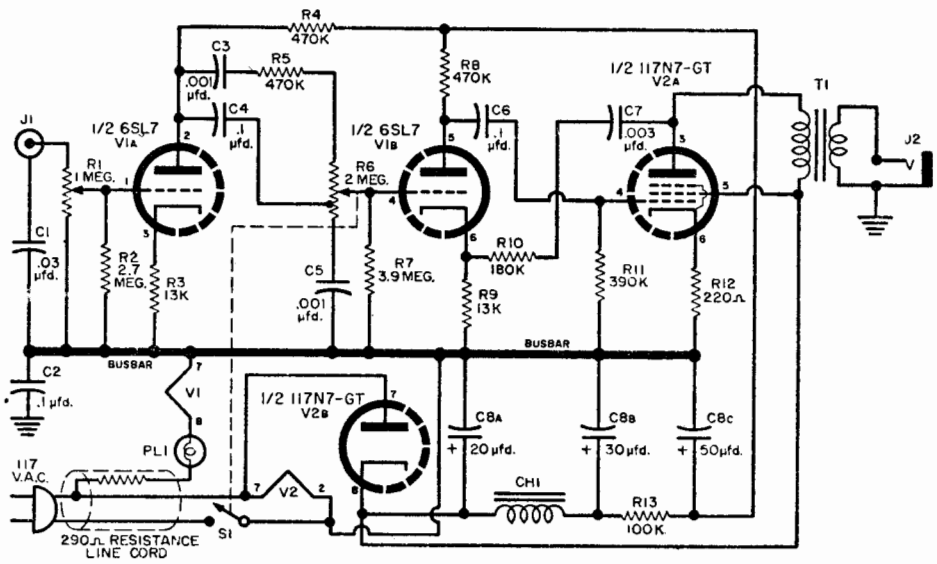

Fig. 157—Schematic of two-tube amplifier.

PARTS LIST

C1—0.03- μ fd., 300-volt paper tubular capacitor	R4, R5, R8—470,000-ohm, 1-watt resistor
C2, C4, C6—0.1- μ fd., 300-volt capacitor	R6—2-megohm potentiometer, tapped at 500,000 ohms, with switch (1RC 2-meg. 13-139X)
C3, C5—0.001- μ fd., 200-volt paper tubular capacitor	R7—3.9-megohm, $\frac{1}{2}$ -watt resistor
C7—0.003- μ fd., 220-volt paper tubular capacitor	R10—180,000-ohm, 1-watt resistor
C8a/C8b/C8c—20-30-50- μ fd., 150-volt d.c. electrolytic capacitor	R11—390,000-ohm, $\frac{1}{2}$ -watt resistor
CH1—450-ohm, 50-ma. filter choke (see text)	R12—220-ohm, $\frac{1}{2}$ -watt resistor
PL1—6.8-volt pilot light (screw base) and socket	R13—100,000-ohm, $\frac{1}{2}$ -watt resistor
J1—Phono jack with insulating washer	S1—S.p.s.t. switch (on R6)
J2—Microphone type jack	T1—Universal output transformer (Stancor A-3856 or equivalent)
R1—1-megohm audio taper potentiometer (Mallory Midgetrol 1-meg. Taper 1)	V1—6SL7-GT tube
R2—2.7-megohm, $\frac{1}{2}$ -watt resistor	V2—117 N7-GT tube
R3, R9—13,000-ohm, 1-watt resistor	1—5" x 7" chassis (minimum)
	1—290-ohm resistor line cord
	Misc. tube sockets, wire, hardware, knobs

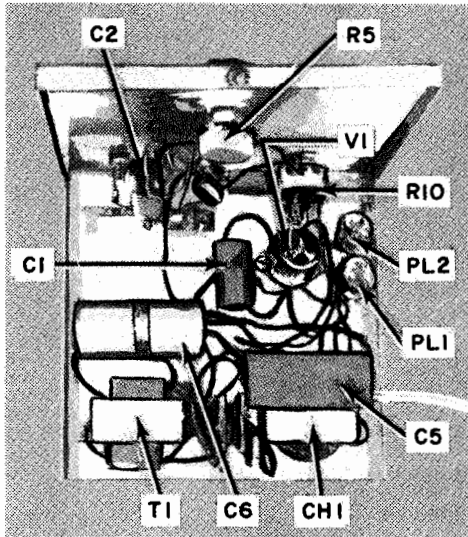

Fig. 158—Underside of amplifier chassis showing terminal board and point-to-point wiring. Note that the major components are crowded to the back of the chassis to keep hum away from the tone and volume controls.

The pilot light (PL1) is connected in series with the 6SL7 heater. Although a choke (CH1) is shown in the wiring diagram, the constructor may substitute a 450-ohm resistor (5 watts) if he wishes.

All leads should be as close to the chassis as possible. Because of the nature of the resistor line cord, the "on-off" switch (S1) is connected in the ground lead. The cord dissipates heat when working normally. Don't be alarmed if it becomes quite hot to the touch.

Wire carefully and avoid large blobs of solder. In the case of the ground lug, use a two- or three-lug terminal strip and connect the lugs together with a heavy piece of bare, copper wire. Avoid letting solder run down to touch the chassis—this could result in a direct short. Remember that when the line plug is inserted and the switch is "off," the ground side of the circuit will be safe to touch, but anything connected to the other side of the line definitely will not be safe!

The output transformer is a high-quality universal-type transformer such as the Stancor A-3856. Follow the manufacturer's instruction sheet in matching your speaker impedance to the 3,000-ohm load resistance of the 117N7. For increased high-frequency response, try the A-3850, a unit of slightly larger size.

When you first turn the amplifier on, a bright flash of light will be seen in the 117N7 tube, which will then heat up rapidly. The pilot light (if connected in series) should be operating near its maximum rating. With nothing connected to the input and the volume control in its loudest position, hum should be inaudible. (There will be a slight hum if you substitute a resistor for the filter choke.) If any hum is heard, reverse the line plug.

Connecting a record changer or tuner may produce some hum. If it does, reverse both plugs several times until an ideal match is indicated by an absence of hum.

For best operation, the constructor should adhere closely to all specified circuit values—with several exceptions. One exception is R13, which is in the power-supply circuit. If for some reason you would like more gain, this resistor can be brought down to 50,000 ohms to supply more plate voltage to the 6SL7.

Other components open to change are R10 and C7, which form the feedback loop. The over-all gain of the amplifier can be adjusted at this point. Decreasing the value of R10 decreases the gain, and vice versa. C7 controls the amount of feedback at lower frequencies. The larger the value, the more bass is fed back to the cathode, which results in decreased bass response. If you have a highly efficient speaker enclosure, you may want to use a larger capacitor and decrease the amount of bass, C7 can be varied up to 0.01 microfarad.

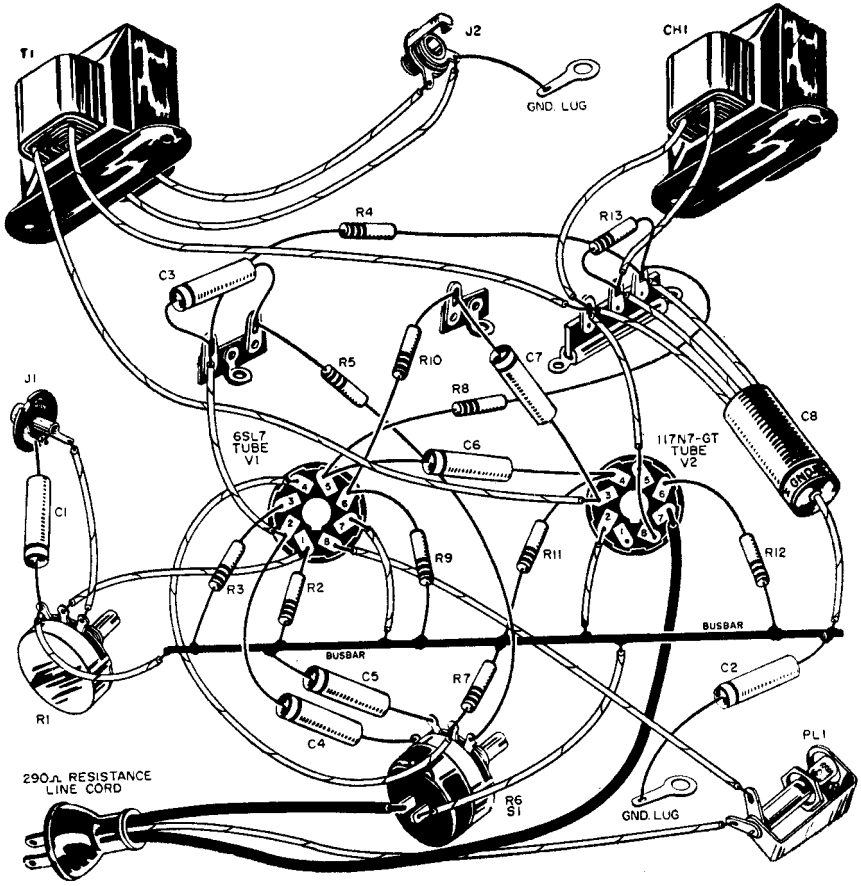

Fig. 159—Wiring of amplifier.

Transistorized Intercom



Fig. 160—Transistorized intercom.

The home intercom system is a “natural” for “transistorization.” By powering it from a 6-volt battery, the possibility of shock or power-supply hum can be eliminated. This unit is designed around three CK722 transistors and a type 2N255 power transistor. The circuit is simple, and you should have little difficulty in assembly.

The chassis can be constructed of a scrap piece of perforated Masonite, $\frac{1}{4}$ -inch plywood (with holes drilled for parts mounting) or even sections of an old cigar box. It is a good idea to apply a couple of coats of acrylic spray to the “chassis” before mounting the components. This will prevent moisture from wilting it after installation in the cabinet.

The power transistor is mounted with 6-32 nuts and bolts, as are T1, T2, and T3. Place a soldering lug under one of the 2N255 mounting nuts and use it for the collector connections. (The 2N255 has the collector internally connected to its shell, therefore, the shell cannot be grounded.) Insert tie points wherever convenient and run the common leads to them. The rear bracket and the brackets mounting the switch and control can be cut from an aluminum angle or shaped from sections of a “tin” can.

PARTS LIST

- B1—6-volt battery
 C1, C3—2- μ fd., 6-volt electrolytic capacitor
 C2, C4—10- μ fd., 6-volt electrolytic capacitor
 C5—30- μ fd., 6-volt electrolytic capacitor
 C6—100- μ fd., 6-volt electrolytic capacitor
 R1, R9—100-ohm, $\frac{1}{2}$ -watt carbon resistor
 R2—330,000-ohm, $\frac{1}{2}$ -watt carbon resistor
 R3—3000-ohm potentiometer (Gain Control)
 R4, R7—4700-ohm, $\frac{1}{2}$ -watt carbon resistor
 R5—270,000-ohm, $\frac{1}{2}$ -watt carbon resistor
 R6—47-ohm, $\frac{1}{2}$ -watt carbon resistor
 R8—100,000-ohm, $\frac{1}{2}$ -watt carbon resistor
 R10—4700-ohm, 1-watt carbon resistor (see text)
 S1—S.p.s.t. toggle switch (Power)
 S2—D.p.d.t. spring return rotary switch (Centralab No. 1464)
 S3—S.p.d.t. normally open push-button switch (Mallory 2003-L)—in Remote
 T1—Input transformer; 3-ohm primary, 4000-ohm secondary (Argonne No. AR-125)
 T2—Driver transformer; 500-ohm primary, 8-ohm secondary (Argonne No. AR-125)
 T3—Output transformer; 48-ohm primary, 3.2-ohm secondary (Argonne No. AR-503)
 TR1, TR2, TR3—CK722 transistor (Raytheon)
 TR4—2N255 transistor (CBS Hytron)
 SPKR.—4" PM speaker, 3-4 ohm voice coil

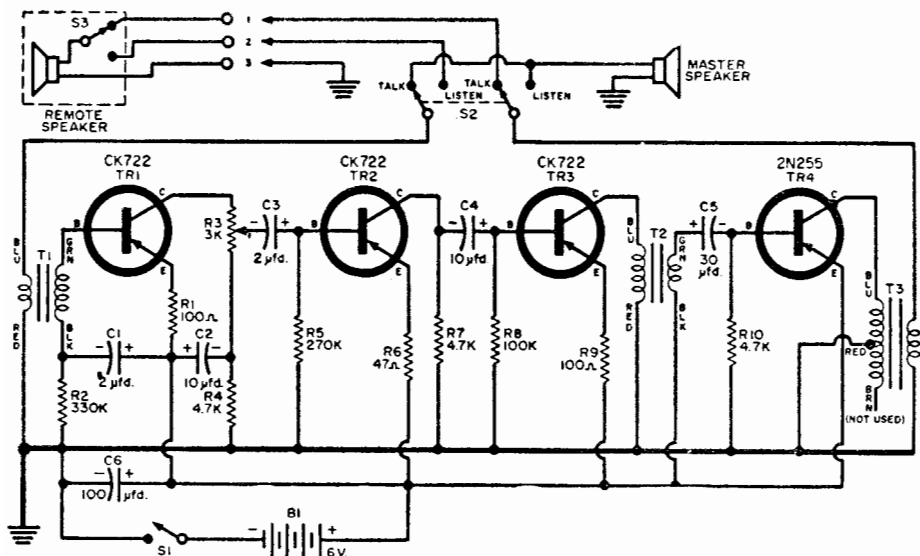

Fig. 161—Intercom circuit uses three CK722 transistors and one 2N255 power transistors.

Layout and wiring are not especially critical as long as care is taken to keep input and output circuits well separated, preferably at opposite ends of the chassis. If your intercom shows a tendency to whistle, squeal, or howl, the problem is probably due to audio coupling through the power supply or to bad parts layout.

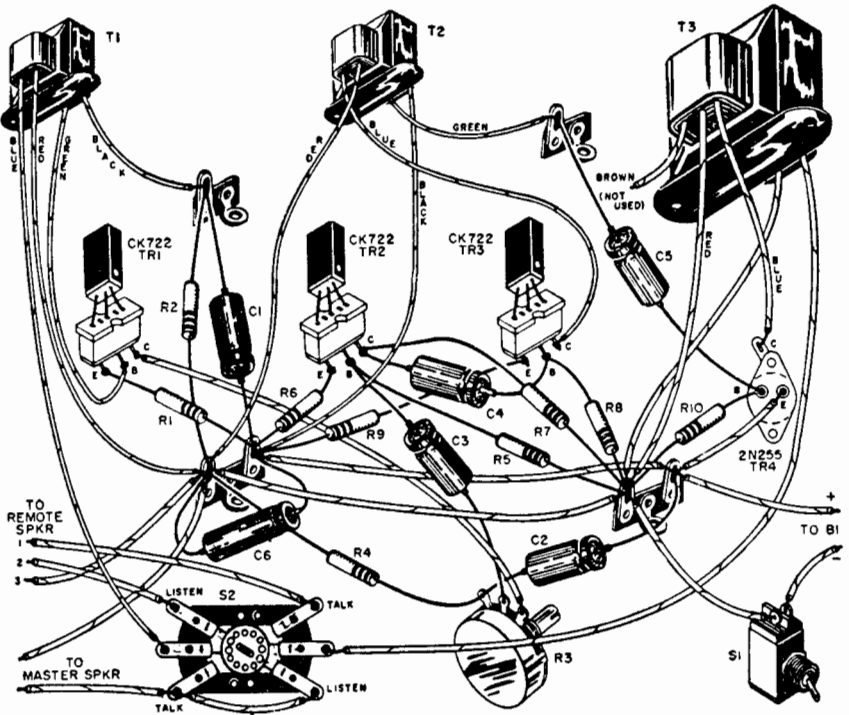

Fig. 162—Pictorial of parts mounting of transistor for final assembly.

The base resistor (R10) of the output stage is of a higher than normal value in order to minimize battery drain. If the circuit shows a tendency to distort or overload on strong signals, the value of R10 can be reduced. With the original 47,000-ohm value, the battery drain will be approximately 50 milliamperes. Lowering the value of R10 will increase the amount of current drawn. As far as the input and output connectors are concerned, any convenient three-terminal strip will do. Binding head connectors were used in the model, but other types may be more easily available.

The 6-volt battery can be made up of 1½-volt "D" flashlight cells mounted in series-wired battery clips. If more convenient, a single 6-volt portable-radio type "A" battery can be used.

Operation of the master unit can be achieved with any standard PM speaker as a remote. Standard three-wire intercom cable should be used for interconnection of the master and remote. The remote speaker will transmit only when its push-to-talk switch is depressed. This feature can be disabled by connecting a jumper wire between output terminals 1 and 2.

After installation, the gain control, which is mounted at the rear of the chassis, should be be preset to a standard operating level and should not need readjustment until the batteries age.

The little job's independence of the a.c. power line makes it an ideal companion in areas where power is either not available or unreliable.

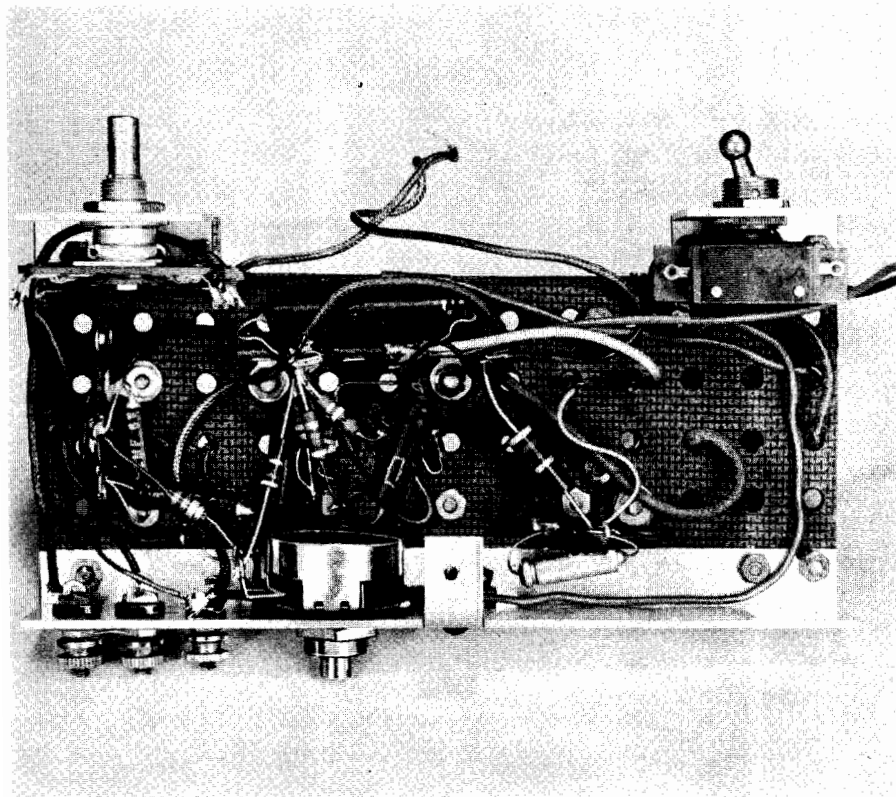

Fig. 163—Amplifier chassis shown from below with major parts installed.

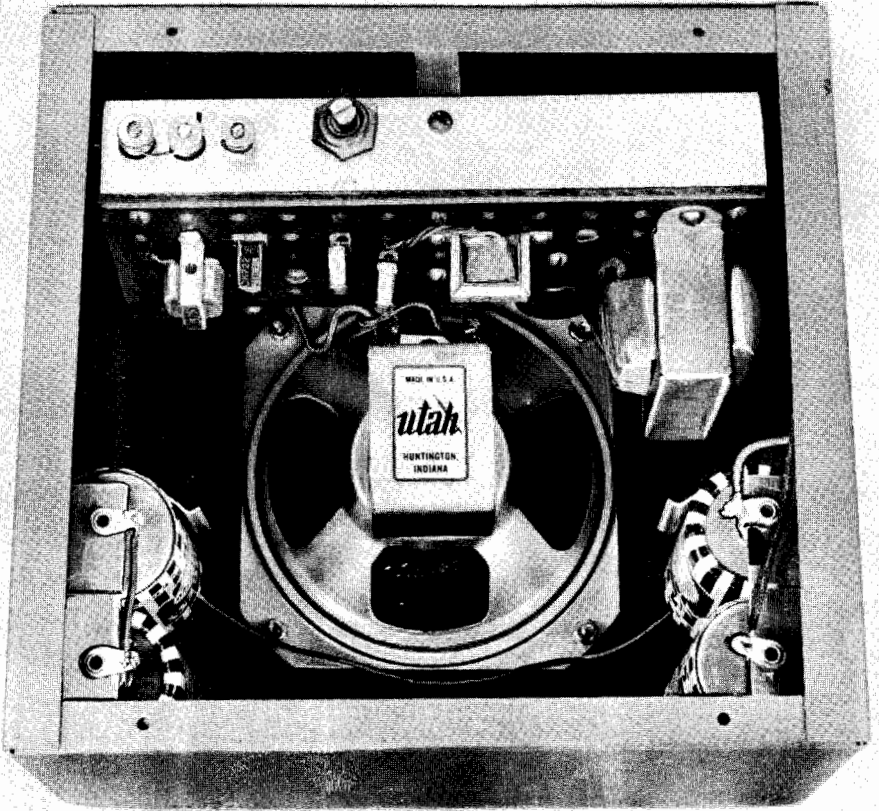

Fig. 164—Completed intercom mounted in cabinet.

Transistorized Photoflash

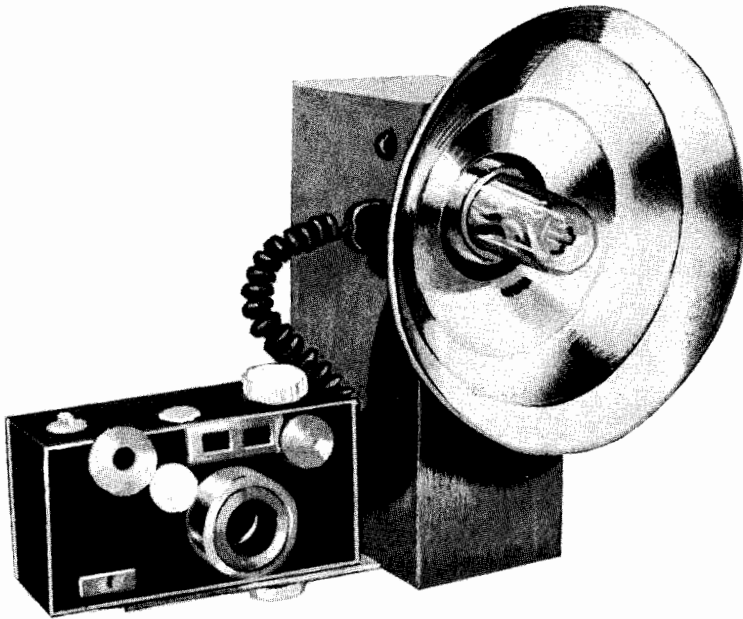

Fig. 165—Electronic photoflash uses transistor oscillator to supply high voltage for flashbulb.

The electronic photoflash outfit described here is a good and comparatively inexpensive compromise. It operates from either house current or from four inexpensive size D flashlight cells, so battery cost is trifling. It is a single unit that is easy to build and is rugged and dependable in operation. The photoflash tube is mounted in neoprene under a glass dome to protect it from injury.

In order to design in all of these features, it was necessary to accept more size and weight than is considered ideal— $2\frac{3}{4}$ inches by $4\frac{1}{2}$ inches by $7\frac{3}{4}$ inches, and $4\frac{1}{2}$ pounds with batteries. The housing can be constructed of .063-inch aluminum sheet with heavier gage (.125-inch) in the base plate to which the mounting bracket is attached. It is assembled by using self-tapping sheet-metal screws to hold aluminum rods or angles as cleats.



Fig. 166—Battery compartment with batteries installed.

Components are mounted on each of the side panels and prewired before the cabinet is assembled. Power transformer, transistors (mounted externally) and resistors of the oscillator, and the battery terminals are on the back panel. The batteries are a snug fit between the back panel and the main storage capacitor.

A removable section in the bottom of the case provides access to the batteries. The lower battery contact, an aluminum strip, is glued to a strip of plastic to insulate it from the case. This plastic strip is glued to the inside surface of the battery access door plate.

The transistors must be mounted on $\frac{3}{16}$ -inch composition with the mounting screws insulated from the case with composition shoulder washers. A thick plastic should be used between transistors and case because, with the use of thinner material, an electrostatic voltage may develop in the case.

No part of the circuit is electrically connected to the case because most camera flash synchronization contacts have one side grounded to the camera body. By keeping the case isolated, there is no need for a polarized flash cord connection.

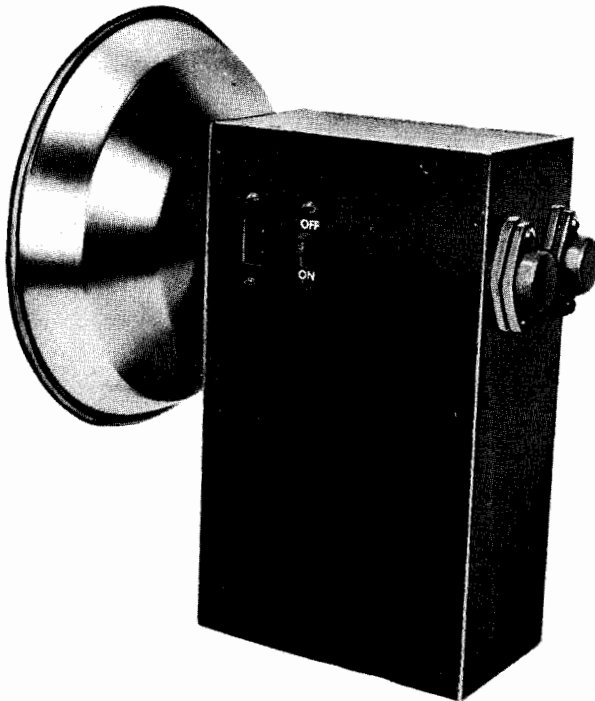

Fig. 167—Left-panel view showing power switch and recessed 117-volt socket.

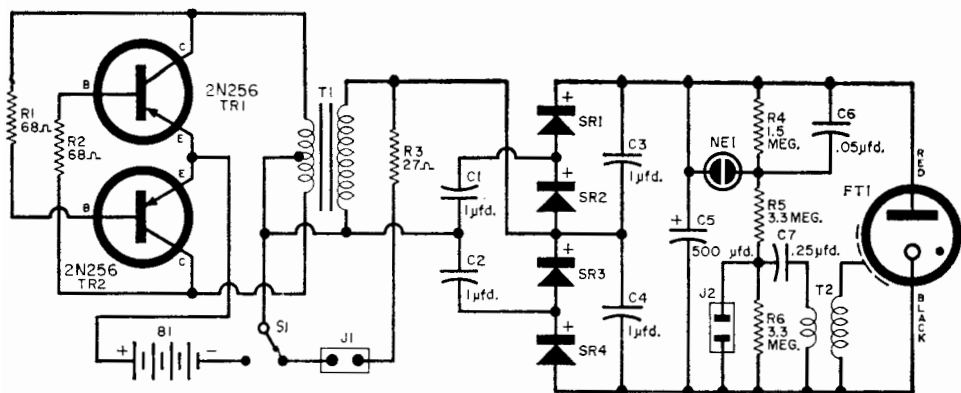

Fig. 168—Schematic of transistorized photoflash.

PARTS LIST

- B1—Four 1.5-volt standard size "D" dry cells
 C1, C2, C3—1.0- μ fd., 400-volt tubular capacitor
 C5—500- μ fd., 450-volt electrolytic capacitor
 (Sangamo DCM or equivalent)
 C6—0.05- μ fd., 200-volt tubular capacitor
 C7—0.25- μ fd., 400-volt tubular capacitor
 FT1—Flash tube and reflector combination (Amglo
 HD-2AR; available from Amglo Corp., 2037 W.
 Division St., Chicago, Ill.)
 J1—TV-type a.c. input receptacle
 J2—Rectangular a.c. outlet (for camera sync
 connection)
 NE1—NE-51 neon lamp
 R1, R2—68-ohm, 1-watt resistor
 R3—27-ohm, 1-watt resistor
 R4—1.5-megohm, $\frac{1}{2}$ -watt resistor
 R5, R6—3.3-megohm, $\frac{1}{2}$ -watt resistor
 S1—S.p.d.t. slide switch
 SR1, SR2, SR3, SR4—Silicon rectifier (Sarkes Tarzian
 M150)
 T1—Modified 6.3-volt filament transformer (Stancor
 P6134—see text)
 T2—Ignition coil (Amglo ST-25)
 TR1, TR2—2N256 power transistor (CBS)

The left panel of the case has the s.p.d.t. switch (S1) and a recessed TV-type a.c. connection (J1) mounted on it. An ordinary TV cheater cord is used when the flash is operated on house current, and the switch is wired so that the a.c. input is in the circuit only when the batteries are off.

On the right-hand panel is an ordinary a.c. outlet (J2) into which the flash cord from the camera is plugged, the neon charge-indicating lamp (NE1) is mounted in a $\frac{5}{8}$ -inch rubber grommet and connected

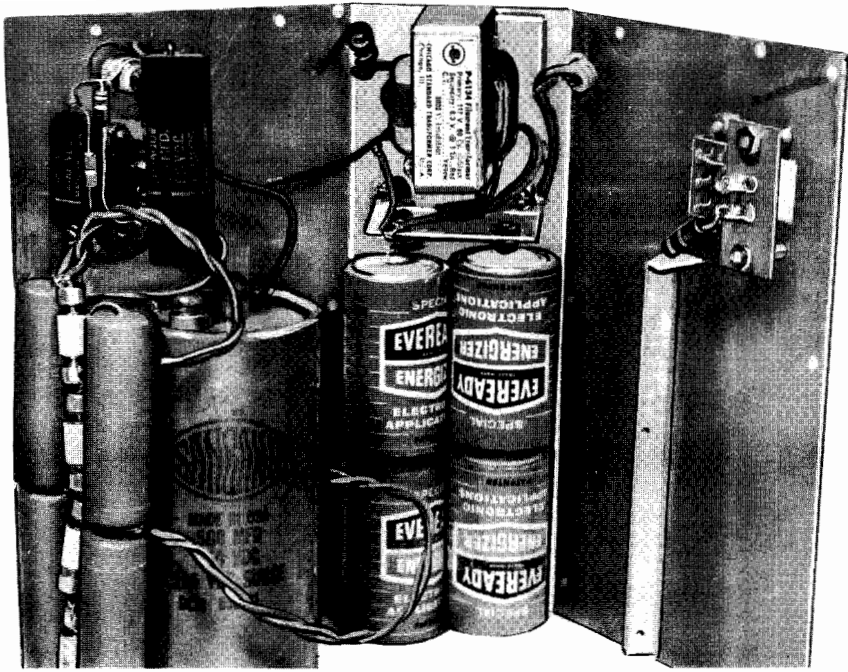

Fig. 169—Interior view of flash unit with front panel removed. Note the rods which hold the cells in place.

to a 4-point tie strip. Tape the tiny trigger transformer (T2) to the tie strip. All of the components shown in the schematic between the storage capacitor (C5) and the flash tube (FT1) can be mounted on this panel and wired before it is attached to the case.

The flash tube and its reflector are mounted on the front panel, using the two bolts provided. Note that the red lead goes to the positive terminal of C5, the black lead to negative, and the white lead to T2. This leaves only the four silicon rectifiers and the four capacitors (C1, C2, C3, and C4) of the voltage quadrupler. They also are prewired using a physical layout which corresponds to the placement shown in the schematic. Considerable space is saved by using pigtailed on the rectifiers instead of mounting clips.

The quadrupler is wrapped in plastic and the unit placed against the front panel when the case is assembled. It is held in place with the storage capacitor which is kept in position with two shaped aluminum rods fastened to the side panels.

Assemble the front, rear, and right side panels of the case, put the voltage quadrupler and storage capacitor in position, and complete most of the interconnecting wiring. Fasten the left panel in place and wire the switch and a.c. input from above. The top and bottom of the case are then fastened in place to complete the assembly.

Use a ¼-inch tapped hole in the heavy bottom plate to attach the camera mounting bracket. Hold the battery access panel in place with one screw. Mark the battery polarity on the side of the opening to reduce the possibility of inserting the batteries incorrectly. If desired, the battery trap door can be hinged. The plate that is mounted on the door and which contacts the positive and negative terminals of the batteries must be insulated from the door itself. It may be glued to a piece of plastic which, in turn, is glued to the door panel.

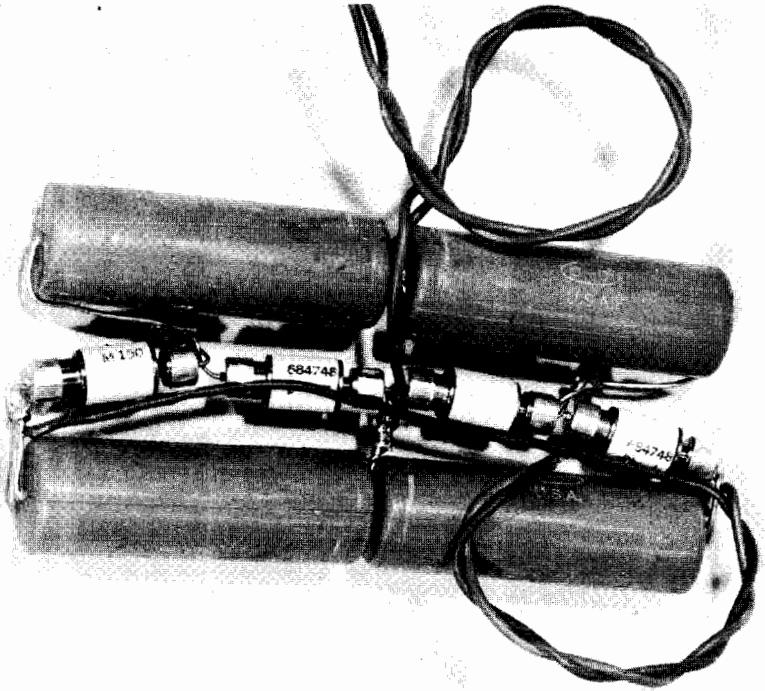

Fig. 170—Voltage quadrupler subassembly as it is wired immediately before being insulated.

The only component which requires modification is the power-supply transformer (T1). Take apart its frame and laminations and remove the entire center-tapped 6.3-volt winding. Using only 20 feet of this wire, rewind the secondary, taking off a tap at its mid-point, and reassemble it. This rather simple operation is necessary to provide sufficient voltage for satisfactory operations as the battery output drops with use.

The layout shown is not offered as the final answer. The unit could probably be made smaller and with a different shape. Some builders may like a two-unit flash outfit with the power and storage components carried in an over-the-shoulder case and the rest of the components mounted with the flash tube and reflector on the camera. Amglo offers a back cover for the reflector for such an installation.

That's all there is to it!

