

REFERENCE DATA

for

RADIO ENGINEERS

second edition

Federal Telephone and Radio Corporation

an associate of

International Telephone and Telegraph Corporation

67 Broad Street • New York 4, N. Y.

**Copyright 1946 by
Federal Telephone and Radio Corporation**

Second Edition

**Printed in the U.S.A. by
J. J. Little & Ives Co., N. Y.**



Foreword

Widespread acceptance of the four printings of the first edition of Reference Data for Radio Engineers prompted this larger and improved second edition. Like its predecessor, it is presented by the Federal Telephone and Radio Corporation as an aid in the fields of research, development, production, operation, and education. In it will be found all the material that proved so useful in the first edition along with much additional data—some the result of helpful suggestions from readers, others stemming from rapid advances in the art, and still others now made possible by declassification of many war developments.

While the general arrangement remains unchanged, the present edition has been greatly enlarged and a subject index included. Chapters on transformers and room acoustics have been added. The material on radio propagation and radio noise has been revised. Because of their importance in television, in radar, and in laboratory technique, the data on cathode-ray tubes have been considerably expanded.

The section on electrical circuit formulas has been greatly enlarged; additions include formulas on T-II and Y- Δ transformations, amplitude modulation, transients, and curves and numerous formulas on selective circuits. The attenuator section contains comprehensive design formulas and tables for various types of attenuators. The number of mathematical formulas also has been considerably increased.

As revised, the wave-guide chapter includes equations for both rectangular and cylindrical guides plus illustrations of field distribution patterns. Several methods of coupling to the $TE_{0,1}$ mode are illustrated. A table of standard rectangular wave guides and connectors, giving useful frequency range and attenuation, has been added. Design curves for the gain and beam width of rectangular electromagnetic horn radiators are included, and a simple formula for the gain of a paraboloid reflector is given.

Many very helpful suggestions were received from the Armed Services.

Acknowledgment is made to Edward J. Content, consulting engineer, for his contribution of the chapter on room acoustics; its inclusion was made possible largely through the courtesy of the Western Electric Company in permitting the use of their engineering data. Acknowledgment also is due to I. E. Lempert, Allen B. Dumont Laboratories, Inc., for the descriptive material on cathode-ray tubes; and to Professor L. Brillouin of Harvard University for advice and suggestions on the wave-guide chapter.

In the compilation of this reference book, the cooperation of the following I.T. & T. associate companies was invaluable:

International Telecommunication Laboratories, Inc., New York, N. Y.

E. M. Deloraine, president, and E. Labin, technical director

American Cable and Radio Corporation, New York, N. Y.

Haraden Pratt, vice president and chief engineer

Standard Telephones and Cables, Ltd., London, England.

C. E. Strong, chief engineer of radio division

International Telephone and Telegraph Corporation, New York, N. Y.

George Lewis, assistant vice president, and H. P. Westman, associate editor of *Electrical Communication*.

Recognition for contribution of specific material:

Federal Telecommunication Laboratories, Inc., New York, N. Y.

H. Busignies, director, G. S. Burroughs, W. A. Cobb, S. Frankel, J. J. Glauber, D. D. Grieg, A. G. Kandoian, N. Marchand,* C. R. Muller, E. M. Ostlund, W. Sichak, L. D. Smullin, N. S. Tierney, A. R. Vallarrino, M. W. Wallace, A. J. Warner, and J. K. Whitteker

Federal Telephone and Radio Corporation, Newark, N. J.

E. G. Ports, technical director of radio division, H. Baker, W. F. Bonner, C. L. Howk, W. W. Macalpine, G. T. Royden, and A. K. Wing

Mackay Radio and Telegraph Company, New York, N. Y.

R. McSweeney, C. E. Scholz, and L. Spangenberg

International Standard Electric Corporation, New York, N. Y.

J. C. Frick, G. H. Gray, and E. S. McLarn

H. H. Buttner, chairman

Radio Reference Book Committee

H. T. Kohlhaas, editor

Editor of *Electrical Communication*

F. J. Mann, assistant editor

Managing Editor of *Electrical Communication*

*Formerly of Federal Telecommunication Laboratories, Inc.

Contents

Chapter 1 — General information

Conversion factors	11
Fractions of an inch with metric equivalents	14
Miscellaneous data	14
Greek alphabet	15
Unit conversion table	16
Electromotive force—series of the elements	18
Position of metals in the galvanic series	18
Atomic weights	19
Centigrade table of relative humidity or percent of saturation	20
Atmospheric pressure chart	22
Weather data	23
Temperature extremes	23
Precipitation extremes	23
World temperatures	23
World precipitation	24
Principal power supplies in foreign countries	25
World time chart	27
Electromagnetic frequency spectrum	28
Radio frequency classifications	28
Wavelength vs frequency chart	29
Wavelength vs frequency formulas	29
Frequency tolerances	30
Frequency band widths occupied by the emissions	32
Tolerances for the intensity of harmonics of fixed, land, and broadcasting stations	32
Classification of emissions	33
Relation between decibels and power, voltage, and current ratios	34

Chapter 2 — Engineering and material data

Copper wire table—standard annealed copper	35
Copper wire table—English and metric units	36
Solid copperweld wire—mechanical and electrical properties	37
Standard stranded copper conductors—American wire gauge	38
Machine screw head styles, method of length measurement	38
Standard machine screw data including hole sizes	39
Insulating materials	40
Plastics: trade names	41
Wind velocities and pressures	42
Temperature chart of heated metals	43
Physical constants of various metals and alloys	44
Thermocouples and their characteristics	46
Melting points of solder	47
Spark gap voltages	48
Head of water in feet and approximate discharge rate	49
Materials and finishes for tropical and marine use	50
Torque and horsepower	51

Chapter 3 — Audio and radio design

Resistors and capacitors—color code	52
Resistors, fixed composition	52
Standard color coding for resistors	53
Capacitors, fixed mica dielectric	55
Capacitors, fixed ceramic	57
Inductance of single-layer solenoids	58
Magnet wire data	60
Reactance charts	61
Impedance formulas	64
Skin effect	71
Network theorems	74
Electrical circuit formulas	74
Attenuators	100
Filter networks	115

Chapter 4 — Rectifiers and filters

Typical rectifier circuit connections and circuit data	118
Rectifier filter design—ripple voltage vs LC for choke-input filters	120
Rectifier filter design—ripple voltage vs RC for capacitor-input filters	121

Chapter 5—Iron-core transformers and reactors

Major transformer types	122
Major reactor types	122
Temperature, humidity, and pressure effects	123
General limitations	123
Design of power-supply transformers	124
Round enameled copper wire data	126

Chapter 6—Vacuum tubes

Nomenclature	127
Coefficients	127
Terminology	128
Formulas	129
Performance limitations	130
Electrode dissipation data	131
Filament characteristics	132
Ultra-high-frequency tubes	134
Cathode-ray tubes	136
Army-Navy preferred list of electron tubes	142

Chapter 7—Vacuum tube amplifiers

Classification	143
General design	143
Graphical design methods	146
Classification of amplifier circuits	155
Cathode follower data	157
Resistance-coupled audio amplifier design	158
Negative feedback	159
Reduction in gain caused by feedback	160
Distortion	164

Chapter 8—Room acoustics

General considerations for good room acoustics	165
Good acoustics—governing factors	165
Room sizes and proportions for good acoustics	165
Optimum reverberation time	166
Computation of reverberation time	169
Electrical power levels required for public address requirements	171
General	177

Chapter 9—Wire transmission

Telephone transmission line data	179
Frequency allocation chart for type J and K carrier systems	185
Frequency allocation chart for carrier systems	186
Frequency allocation and modulation steps in the L carrier system (coaxial cable)	188
Noise and noise measurement—wire telephony	189
Telegraph facilities	192
Telegraph printer systems	192
Frequency of printing telegraph systems in cycles per second	192
Comparison of telegraph codes	193

Chapter 10—Radio frequency transmission lines

Formulas for uniform transmission lines	194
Surge impedance of uniform lines	195
Transmission line data	196
Transmission line attenuation due to load mismatch	198
Impedance matching with shorted stub	199
Impedance matching with open stub	199
Impedance matching with coupled section	200
Army-Navy standard list of radio-frequency cables	201
Attenuation of standard r-f cables vs frequency	204
Length of transmission line	205
Attenuation and resistance of transmission lines at ultra-high frequencies	206

Chapter 11—Wave guides and resonators

Propagation of electromagnetic waves in hollow wave guides	207
Rectangular wave guides	208
Circular wave guides	213
Electromagnetic horns	217
Resonant cavities	219
Some characteristics of various types of resonators	222
Additional cavity formulas	223
Recommended rectangular wave guides	223

Chapter 12—Radio propagation and noise

Propagation of medium and long waves	224
Propagation of short waves	226
Propagation forecasts for short waves	231
Propagation of very short waves	237
U-H-F path length and optical line-of-sight distance range of radio waves	238
Great circle calculations	240
Time interval between transmission and reception of reflected signal	244
Radio noise and noise measurement	244

Chapter 13 — Antennas

Field intensity from an elementary dipole	250
Field of an elementary dipole at great distance	252
Field of an elementary dipole at short distance	252
Field of an elementary dipole at intermediate distance	253
Field intensity from a vertically polarized antenna with base close to ground	253
Vertical radiators	254
Field intensity and radiated power from a half-wave dipole in free space	258
Radiation from end-fed conductor of any length in space	260
Maxima and minima of radiation from a single-wire radiator	261
Rhombic antennas	261
Antenna arrays	263

Chapter 14 — Non-sinusoidal and modulated wave forms

Relaxation oscillators	272
Electronic integration methods	274
Electronic differentiation methods	276
Fourier analysis of recurrent wave forms	277
Analysis of commonly encountered wave forms	281
Modulated wave forms	288

Chapter 15 — Mathematical formulas

Mensuration formulas	291
Formulas for complex quantities	294
Algebraic and trigonometric formulas	294
Approximations for small angles	296
Quadratic equation	296
Arithmetical progression	296
Geometrical progression	297
Combinations and permutations	297
Binomial theorem	297
Maclaurin's theorem	297
Taylor's theorem	297
Trigonometric solution of triangles	298
Complex hyperbolic and other functions	299
Table of integrals	300

Chapter 16 — Mathematical tables

Exponentials	303
Common logarithms of numbers and proportional parts	304
Natural trigonometric functions for decimal fractions of a degree	306
Logarithms of trigonometric functions for decimal fractions of a degree	310
Natural logarithms	314
Hyperbolic sines	316
Hyperbolic cosines	317
Hyperbolic tangents	318
Multiples of 0.4343	318
Multiples of 2.3026	318
Bessel functions	319

General information

Conversion factors

to convert	into	multiply by	conversely multiply by
Acres	Square feet	4.356×10^4	2.296×10^{-6}
Acres	Square meters	4,047	2.471×10^{-4}
Ampere-hours	Coulomb	3,600	2.778×10^{-4}
Amperes per sq cm	Amperes per sq inch	6.452	0.1550
Ampere turns	Gilberts	1.257	0.7958
Ampere turns per cm	Ampere turns per inch	2.540	0.3937
Atmospheres	Mm of mercury @ 0° C	760	1.316×10^{-3}
Atmospheres	Feet of water @ 4° C	33.90	2.950×10^{-2}
Atmospheres	Inches mercury @ 0° C	29.92	3.342×10^{-2}
Atmospheres	Kg per sq meter	1.033×10^4	9.678×10^{-6}
Atmospheres	Pounds per sq inch	14.70	6.804×10^{-2}
Btu	Foot-pounds	778.3	1.285×10^{-3}
Btu	Joules	1,054.8	9.480×10^{-4}
Btu	Kilogram-calories	0.2520	3.969
Btu	Horsepower-hours	3.929×10^{-4}	2,545
Bushels	Cubic feet	1.2445	0.8036
Centigrade	Fahrenheit	$(C^\circ \times 9/5) + 32$	$(F^\circ - 32) \times 5/9$
Circular mils	Square centimeters	5.067×10^{-6}	1.973×10^6
Circular mils	Square mils	0.7854	1.273
Cubic feet	Cords	7.8125×10^{-3}	128
Cubic feet	Gallons (liq US)	7.481	0.1337
Cubic feet	Liters	28.32	3.531×10^{-2}
Cubic inches	Cubic centimeters	16.39	6.102×10^{-2}
Cubic inches	Cubic feet	5.787×10^{-4}	1,728
Cubic inches	Cubic meters	1.639×10^{-6}	6.102×10^4
Cubic inches	Gallons (liq US)	4.329×10^{-3}	231
Cubic meters	Cubic feet	35.31	2.832×10^{-2}
Cubic meters	Cubic yards	1.308	0.7646
Degrees (angle)	Radians	1.745×10^{-2}	57.30
Dynes	Pounds	2.248×10^{-6}	4.448×10^5
Ergs	Foot-pounds	7.367×10^{-8}	1.356×10^7
Fathoms	Feet	6	0.16666
Feet	Centimeters	30.48	3.281×10^{-2}
Feet of water @ 4° C	Inches of mercury @ 0° C	0.8826	1.133
Feet of water @ 4° C	Kg per sq meter	304.8	3.281×10^{-3}

Conversion factors *continued*

to convert	into	multiply by	conversely multiply by
Feet of water @ 4° C	Pounds per sq foot	62.43	1.602×10^{-2}
Foot-pounds	Horsepower-hours	5.050×10^{-7}	1.98×10^6
Foot-pounds	Kilogram-meters	0.1383	7.233
Foot-pounds	Kilowatt-hours	3.766×10^{-7}	2.655×10^6
Gallons	Cubic meters	3.785×10^{-3}	264.2
Gallons (liq US)	Gallons (liq Br Imp)	0.8327	1.201
Gauss	Lines per sq inch	6.452	0.1550
Grams	Dynes	980.7	1.020×10^{-3}
Grams	Grains	15.43	6.481×10^{-2}
Grams	Ounces (avoirdupois)	3.527×10^{-2}	28.35
Grams	Pounds	7.093×10^{-2}	14.10
Grams per cm	Pounds per inch	5.600×10^{-3}	178.6
Grams per cu cm	Pounds per cu inch	3.613×10^{-2}	27.68
Grams per sq cm	Pounds per sq foot	2.0481	0.4883
Hectares	Acres	2.471	0.4047
Horsepower (boiler)	Btu per hour	3.347×10^4	2.986×10^{-5}
Horsepower (metric)	Btu per minute	41.83	2.390×10^{-2}
(542.5 ft-lb per sec)			
Horsepower (metric)	Foot-lb per minute	3.255×10^4	3.072×10^{-5}
(542.5 ft-lb per sec)			
Horsepower (metric)	Kg-calories per minute	10.54	9.485×10^{-2}
(542.5 ft-lb per sec)			
Horsepower	Btu per minute	42.41	2.357×10^{-2}
(550 ft-lb per sec)			
Horsepower	Foot-lb per minute	3.3×10^4	3.030×10^{-5}
(550 ft-lb per sec)			
Horsepower (metric)	Horsepower	0.9863	1.014
(542.5 ft-lb per sec)	(550 ft-lb per sec)		
Horsepower	Kg-calories per minute	10.69	9.355×10^{-2}
(550 ft-lb per sec)			
Inches	Centimeters	2.540	0.3937
Inches	Feet	8.333×10^{-2}	12
Inches	Miles	1.578×10^{-5}	6.336×10^4
Inches	Mils	1,000	0.001
Inches	Yards	2.778×10^{-2}	36
Inches of mercury @ 0° C	Lbs per sq inch	0.4912	2.036
Inches of water @ 4° C	Kg per sq meter	25.40	3.937×10^{-2}
Inches of water	Ounces per sq inch	0.5781	1.729
Inches of water	Pounds per sq foot	5.204	0.1922
Joules	Foot-pounds	0.7376	1.356
Joules	Ergs	10^7	10^{-7}
Kilogram-calories	Kilogram-meters	426.9	2.343×10^{-3}
Kilogram-calories	Kilojoules	4.186	0.2389
Kilograms	Tons, long (avdp 2240 lb)	9.842×10^{-4}	1,016
Kilograms	Tons, short (avdp 2000 lb)	1.102×10^{-3}	907.2
Kilograms	Pounds (avoirdupois)	2.205	0.4536
Kg per sq meter	Pounds per sq foot	0.2048	4.882
Kilometers	Feet	3,281	3.048×10^{-4}
Kilowatt-hours	Btu	3,413	2.930×10^{-4}
Kilowatt-hours	Foot-pounds	2.655×10^6	3.766×10^{-7}
Kilowatt-hours	Joules	3.6×10^6	2.778×10^{-7}
Kilowatt-hours	Kilogram-calories	860	1.163×10^{-3}
Kilowatt-hours	Kilogram-meters	3.671×10^5	2.724×10^{-6}
Kilowatt-hours	Pounds carbon oxydized	0.235	4.26
Kilowatt-hours	Pounds water evaporated from and at 212° F	3.53	0.283

Conversion factors *continued*

to convert	into	multiply by	conversely multiply by
Kilowatt-hours	Pounds water raised from 62° to 212° F	22.75	4.395×10^{-2}
Liters	Bushels (dry US)	2.838×10^{-2}	35.24
Liters	Cubic centimeters	1,000	0.001
Liters	Cubic meters	0.001	1,000
Liters	Cubic inches	61.02	1.639×10^{-2}
Liters	Gallons (liq US)	0.2642	3.785
Liters	Pints (liq US)	2.113	0.4732
Log _e N or 1 _n N	Log ₁₀ N	0.4343	2.303
Lumens per sq foot	Foot-candles	1	1
Lux	Foot-candles	0.0929	10.764
Meters	Yards	1.094	0.9144
Meters per min	Knots (nautical mi per hour)	3.238×10^{-2}	30.88
Meters per min	Feet per minute	3.281	0.3048
Meters per min	Kilometers per hour	0.06	16.67
Microhms per cm cube	Microhms per inch cube	0.3937	2.540
Microhms per cm cube	Ohms per mil foot	6.015	0.1662
Miles (nautical)	Feet	6,080.27	1.645×10^{-4}
Miles (nautical)	Kilometers	1.853	0.5396
Miles (statute)	Kilometers	1.609	0.6214
Miles (statute)	Miles (nautical)	0.8684	1.1516
Miles (statute)	Feet	5,280	1.894×10^{-4}
Miles per hour	Kilometers per minute	2.682×10^{-2}	37.28
Miles per hour	Feet per minute	88	1.136×10^{-2}
Miles per hour	Knots (nautical mi per hour)	0.8684	1.1516
Miles per hour	Kilometers per hour	1.609	0.6214
Pounds of water (dist)	Cubic feet	1.603×10^{-2}	62.36
Pounds of water (dist)	Gallons	0.1198	8.347
Pounds per cu foot	Kg per cu meter	16.02	6.243×10^{-2}
Pounds per cu inch	Pounds per cu foot	1,728	5.787×10^{-4}
Pounds per sq foot	Pounds per sq inch	6.944×10^{-3}	144
Pounds per sq inch	Kg per sq meter	703.1	1.422×10^{-3}
Poundals	Dynes	1.383×10^4	7.233×10^{-6}
Poundals	Pounds (avoirdupois)	3.108×10^{-2}	32.17
Sq inches	Circular mils	1.273×10^6	7.854×10^{-7}
Sq inches	Sq centimeters	6.452	0.1550
Sq feet	Sq meters	9.290×10^{-2}	10.76
Sq miles	Sq yards	3.098×10^6	3.228×10^{-7}
Sq miles	Acres	640	1.562×10^{-3}
Sq miles	Sq kilometers	2.590	0.3861
Sq millimeters	Circular mils	1,973	5.067×10^{-4}
Tons, short (avoir 2000 lb)	Tonnes (1000 kg)	0.9072	1.102
Tons, long (avoir 2240 lb)	Tonnes (1000 kg)	1.016	0.9842
Tons, long (avoir 2240 lb)	Tons, short (avoir 2000 lb)	1.120	0.8929
Tons (US shipping)	Cubic feet	40	0.025
Watts	Btu per minute	5.689×10^{-2}	17.58
Watts	Ergs per second	10 ⁷	10 ⁻⁷
Watts	Foot-lb per minute	44.26	2.260×10^{-2}
Watts	Horsepower (550 ft-lb per sec)	1.341×10^{-3}	745.7
Watts	Horsepower (metric) (542.5 ft-lb per sec)	1.360×10^{-3}	735.5
Watts	Kg-calories per minute	1.433×10^{-2}	69.77

Fractions of an inch with metric equivalents

fractions of an inch	decimals of an inch	millimeters	fractions of an inch	decimals of an inch	millimeters	
$\frac{1}{32}$	$\frac{1}{64}$.0156	0.397	$\frac{33}{64}$.5156	13.097
		.0313	0.794	$\frac{17}{32}$.5313	13.494
	$\frac{3}{64}$.0469	1.191	$\frac{35}{64}$.5469	13.891
$\frac{1}{16}$.0625	1.588	$\frac{9}{16}$.5625	14.288
	$\frac{5}{64}$.0781	1.984	$\frac{37}{64}$.5781	14.684
$\frac{3}{32}$.0938	2.381	$\frac{19}{32}$.5938	15.081
	$\frac{7}{64}$.1094	2.778	$\frac{39}{64}$.6094	15.478
$\frac{1}{8}$.1250	3.175	$\frac{5}{8}$.6250	15.875
	$\frac{9}{64}$.1406	3.572	$\frac{41}{64}$.6406	16.272
$\frac{5}{32}$.1563	3.969	$\frac{21}{32}$.6563	16.669
	$\frac{11}{64}$.1719	4.366	$\frac{43}{64}$.6719	17.066
$\frac{3}{16}$.1875	4.763	$\frac{11}{16}$.6875	17.463
	$\frac{13}{64}$.2031	5.159	$\frac{45}{64}$.7031	17.859
$\frac{7}{32}$.2188	5.556	$\frac{23}{32}$.7188	18.256
	$\frac{15}{64}$.2344	5.953	$\frac{47}{64}$.7344	18.653
$\frac{1}{4}$.2500	6.350	$\frac{3}{4}$.7500	19.050
	$\frac{17}{64}$.2656	6.747	$\frac{49}{64}$.7656	19.447
$\frac{9}{32}$.2813	7.144	$\frac{25}{32}$.7813	19.844
	$\frac{19}{64}$.2969	7.541	$\frac{51}{64}$.7969	20.241
$\frac{5}{16}$.3125	7.938	$\frac{13}{16}$.8125	20.638
	$\frac{21}{64}$.3281	8.334	$\frac{53}{64}$.8281	21.034
$\frac{11}{32}$.3438	8.731	$\frac{27}{32}$.8438	21.431
	$\frac{23}{64}$.3594	9.128	$\frac{55}{64}$.8594	21.828
$\frac{3}{8}$.3750	9.525	$\frac{7}{8}$.8750	22.225
	$\frac{25}{64}$.3906	9.922	$\frac{57}{64}$.8906	22.622
$\frac{13}{32}$.4063	10.319	$\frac{29}{32}$.9063	23.019
	$\frac{27}{64}$.4219	10.716	$\frac{59}{64}$.9219	23.416
$\frac{7}{16}$.4375	11.113	$\frac{15}{16}$.9375	23.813
	$\frac{29}{64}$.4531	11.509	$\frac{61}{64}$.9531	24.209
$\frac{15}{32}$.4688	11.906	$\frac{31}{32}$.9688	24.606
	$\frac{31}{64}$.4844	12.303	$\frac{63}{64}$.9844	25.003
$\frac{1}{2}$.5000	12.700	—	1.0000	25.400

Miscellaneous data

1 cubic foot of water at 4° C (weight)	62.43 lb
1 foot of water at 4° C (pressure)	0.43352 lb per sq in
Velocity of light in vacuum	186,284 mi per sec
Velocity of sound in dry air at 20° C	1129 ft per sec
Degree of longitude at equator	69.17 miles
Acceleration due to gravity, g , at sea-level, 40° N	
Latitude (NY)	32.1578 ft per sq sec
$\sqrt{2g}$	8.02
1 inch of mercury	1.133 ft water
1 inch of mercury	0.4912 lb per sq in
1 radian	$180^\circ \div \pi = 57.3^\circ$
360 degrees	2π radians
π	3.1416
Sine 1'	0.0002929
Side of square	0.707 diagonal of square

Greek alphabet

name	capital	small	commonly used to designate
ALPHA	A	<i>a</i>	Angles, coefficients, attenuation constant, absorption factor, area
BETA	B	<i>β</i>	Angles, coefficients, phase constant
GAMMA	Γ	<i>γ</i>	Complex propagation constant (cap), specific gravity, angles, electrical conductivity, propagation constant
DELTA	Δ	<i>δ</i>	Increment or decrement (cap or small), determinant (cap), permittivity (cap), density, angles
EPSILON	E	<i>ε</i>	Dielectric constant, permittivity, base of natural logarithms, electric intensity
ZETA	Z	<i>ζ</i>	Coordinates, coefficients
ETA	H	<i>η</i>	Intrinsic impedance, efficiency, surface charge density, hysteresis, coordinates
THETA	Θ	<i>θ</i> <i>θ</i>	Angular phase displacement, time constant, reluctance, angles
IOTA	I	<i>i</i>	Unit vector
KAPPA	K	<i>κ</i>	Susceptibility, coupling coefficient
LAMBDA	Λ	<i>λ</i>	Permeance (cap), wavelength, attenuation constant
MU	M	<i>μ</i>	Permeability, amplification factor, prefix micro
NU	N	<i>ν</i>	Reluctivity, frequency
XI	Ξ	<i>ξ</i>	Coordinates
OMICRON	O	<i>o</i>	
PI	Π	<i>π</i>	3.1416
RHO	P	<i>ρ</i>	Resistivity, volume charge density, coordinates
SIGMA	Σ	<i>σ</i> <i>s</i>	Summation (cap), surface charge density, complex propagation constant, electrical conductivity, leakage coefficient
TAU	T	<i>τ</i>	Time constant, volume resistivity, time-phase displacement, transmission factor, density
UPSILON	T	<i>υ</i>	
PHI	Φ	<i>φ</i> <i>φ</i>	Scalar potential (cap), magnetic flux, angles
CHI	X	<i>χ</i>	Electric susceptibility, angles
PSI	Ψ	<i>ψ</i>	Dielectric flux, phase difference, coordinates, angles
OMEGA	Ω	<i>ω</i>	Resistance in ohms (cap), solid angle (cap), angular velocity

Small letter is used except where capital is indicated.

Unit Conversion Table

quantity	symbol	equation	cgs electrostatic unit	1 esu = N ↓	cgs electromagnetic unit	symmetric or Gaussian unit	1 emu = N ↓	1 esu = N ↓
length	l		centimeter	1	centimeter	centimeter	1	1
mass	m		gram	1	gram	gram		
time	t		second	1	second	second		
velocity	v	$v = l/t$	cm/sec	1	cm/sec	cm/sec	1	1
acceleration	a	$a = v/t$	cm/sec ²	1	cm/sec ²	cm/sec ²	1	1
force	F	$F = ma$	dyne	1	dyne	dyne		
work, energy	W	$W = Fl$	erg	1	erg	erg	10 ⁻⁷	10 ⁻⁷
power	P	$P = W/t$	erg/sec	1	erg/sec	erg/sec	10 ⁻⁷	10 ⁻⁷
permittivity of space	ϵ_0		1 statfarad/cm	1	1/c ² abfarad/cm	1 statfarad/cm		
charge	q	$F = q_1q_2/Er^2$	statcoulomb	1/c	abcoulomb	statcoulomb	10/c	10
surface charge density	σ	$\sigma = q/A$	statcoulomb/cm ²	1/c ²	abcoulomb/cm ²	abcoulomb/cm ²	10 ⁹ /c	10 ⁹
volume charge density	ρ	$\rho = q/v$	statcoulomb/cm ³	1/c ³	abcoulomb/cm ³	statcoulomb/cm ³	10/c	10
electric field strength	E	$E = -\text{grad } V$	statvolt/cm	c	abvolt/cm	statvolt/cm	c/10 ⁸	10 ⁻⁸
electric flux density displacement density	D	$D = \epsilon E$	$\frac{1}{4}\pi$ statcoulomb cm ²	1/c	$\frac{1}{4}\pi$ abcoulomb cm ²	$\frac{1}{4}\pi$ statcoulomb cm ²	10/c	
electric flux displacement	Ψ	$\Psi = DA$	line = $\frac{1}{4}\pi$ statcoulomb	1/c	$\frac{1}{4}\pi$ abcoulomb	line = $\frac{1}{4}\pi$ statcoulomb	10/c	
capacitance	C	$C = q/V$	statfarad = cm	1/c ²	abfarad	statfarad or cm	10 ⁹ /c ²	10 ⁹
elastance	S	$S = 1/C$	statdaraf	c ²	abdaraf	statdaraf	c ² /10 ⁹	10 ⁻⁹
polarization	P		statcoulomb/cm ²	1/c	abcoulomb/cm ²	statcoulomb/cm ²	10/c	
potential potential difference	V	$V = F_s = \frac{W}{q}$	statvolt	c	abvolt	statvolt	c/10 ⁸	10 ⁻⁸
emf	e	$e = -d\Phi/dt$	statvolt	c	abvolt	statvolt	c/10 ⁸	10 ⁻⁸
current	I	$I = dq/dt$	statampere	1/c	abampere	statampere	10/c	10
current density	i	$i = I/A$	statampere/cm ²	1/c ²	abampere/cm ²	statampere/cm ²	10/c	10
resistance	R	$R = e/I = V/I$	statohm	c ²	abohm	statohm	c ² /10 ⁹	10 ⁻⁹
resistivity	ρ		statohm × cm	c ²	abohm × cm	statohm × cm	c ² /10 ⁹	10 ⁻⁹
conductance	G	$G = 1/R$	statmho	1/c ²	abmho	statmho	10 ⁹ /c ²	10 ⁻⁹
conductivity	γ	$\gamma = 1/\rho$	statmho/cm	1/c ²	abmho/cm	statmho/cm	10 ⁹ /c ²	10 ⁻⁹
permeability of space	μ_0		$\frac{1}{c^2} = \frac{\text{stathenry}}{\text{cm}}$		abhenry/cm	abhenry/cm		
reluctivity	ν	$\nu = 1/\mu$						
pole strength	m	$F = m_1m_2/\mu r^2$ $= mI$	statunit statpole × cm	c c	unit pole pole × cm pole/cm ²	unit pole pole × cm pole/cm ²		
intensity of magnetization magnetic potential	J \bar{U}			1/c				
magnetic potential diff magnetomotive force	M			1/c	gilbert	gilbert	10/c	10
magnetizing force	H	$H = M/I$		1/c	oersted	oersted	10/c	10
magnetic flux density magnetic induction	B	$B = \mu H$	statweber/cm ²	c	gauss	gauss	c/10 ⁸	10 ⁻⁸
magnetic flux	Φ	$\Phi = BA$	statweber	c	maxwell or line or abvolt-sec	maxwell or line or abvolt-sec	c/10 ⁸	10 ⁻⁸
reluctance	\mathcal{R}	$\mathcal{R} = M/\Phi$		1/c ²	gilbert/maxwell	gilbert/maxwell	10 ⁹ /c ²	10 ⁹
permeance	\mathcal{P}	$\mathcal{P} = 1/\mathcal{R}$		c ²	maxwell/gilbert	maxwell/gilbert		
inductance	L	$L = e/(dI/dt)$	stathenry	c ²	abhenry or cm	abhenry or cm	c ² /10 ⁹	10 ⁻⁹

From "Radio," May, 1944 (compiled by John M. Borst)

The table gives the name and defining equation for each unit in six systems and shows factors for the conversion of all units from one system into any other.

Column 3, "equation," of the table lists the relationships of the physical quantities involved. Consider, as an example, column 1 esu = N emu. The conversion factor in this column can be applied in any of the following ways:

practical unit	1 esu = N MKS N ↓ unrationalized MKS	1 emu = N MKS N ↓ practical unit N = N MKS	1 practical unit N ↓ N = N MKS	unrationalized MKS or Giorgi unit	1 esu = N MKS (R) N ↓ MKS subrationalized	1 emu = N MKS (R) N ↓ subrationalized MKS or Giorgi unit	1 MKS unit unrationalized N MKS (R) N ↓ MKS subrationalized	1 practical unit N ↓ N MKS (R)
centimeter	10 ⁻²	10 ⁻²	10 ⁻²	meter	10 ⁻²	10 ⁻²	1	10 ⁻²
second	10 ⁻³	10 ⁻³		kilogram	10 ⁻³	10 ⁻³	1	1
cond	1	1	1	second	1	1	1	1
v/sec	10 ⁻²	10 ⁻²	10 ⁻²	meter/second	10 ⁻²	10 ⁻²	1	10 ⁻²
v/sec ²	10 ⁻²	10 ⁻²	10 ⁻²	meter/sec ²	10 ⁻²	10 ⁻²	1	10 ⁻²
	10 ⁻⁵	10 ⁻⁵		joule = newton meter	10 ⁻⁵	10 ⁻⁵	1	
joule	10 ⁻⁷	10 ⁻⁷	1	joule	10 ⁻⁷	10 ⁻⁷	1	1
watt	10 ⁻⁷	10 ⁻⁷	1	watt	10 ⁻⁷	10 ⁻⁷	1	1
1 × 10 ¹¹ farad/cm				1/(9 × 10 ⁹) farad meter			1 (36π × 10 ⁹) farad/m	
coulomb	10/e	10	1	coulomb	10/c	10	1	1
coulomb/cm ²	10 ⁵ /c	10 ⁵	10 ⁴	coulomb/m ²	10 ⁵ /c	10 ⁵	1	10 ⁴
coulomb/cm ³	10 ⁷ /c	10 ⁷	10 ⁶	coulomb/m ³	10 ⁷ /c	10 ⁷	1	10 ⁶
ohm/cm	c/10 ⁹	10 ⁻⁹	10 ²	volt/m	c/10 ⁹	10 ⁻⁹	1	10 ²
	10 ⁵ /c	10 ⁵		1/4π coulomb meter ²	10 ⁵ /4πc	10 ⁵ /4π	1/4π	
	10/c	10		1/4π coulomb	10/4πc	10/4π	1/4π	
farad	10 ⁹ /c ²	10 ⁹	1	farad	10 ⁹ /c ²	10 ⁹	1	1
daraf	c ² /10 ⁹	10 ⁻⁹	1	daraf	c ² /10 ⁹	10 ⁻⁹	1	1
	10 ⁵ /c	10 ⁵		coulomb/m ²	10 ⁵ /c	10 ⁵	1	
volt	c/10 ⁹	10 ⁻⁹	1	volt	c/10 ⁹	10 ⁻⁹	1	1
volt	c/10 ⁹	10 ⁻⁹	1	volt	c/10 ⁹	10 ⁻⁹	1	1
ampere	10/c	10	1	ampere	10/c	10	1	1
ampere/cm ²	10 ⁵ /c	10 ⁵	10 ⁴	ampere/m ²	10 ⁵ /c	10 ⁵	1	10 ⁴
ohm	c ² /10 ⁹	10 ⁻⁹	1	ohm	c ² /10 ⁹	10 ⁻⁹	1	1
ohm × cm	c ² /10 ¹¹	10 ⁻¹¹	10 ²	ohm × meter	c ² /10 ¹¹	10 ⁻¹¹	1	10 ²
mho	10 ⁹ /c ²	10 ⁹	1	mho	10 ⁹ /c ²	10 ⁹	1	1
mho/cm	10 ¹¹ /c ²	10 ¹¹	10 ⁻²	mho/meter	10 ¹¹ /c ²	10 ¹¹	1	10 ⁻²
henry/cm				10 ⁻⁷ henry/m			4π × 10 ⁻⁷ henry meter	
	c/10 ⁹	10 ⁻⁹			4πc/10 ⁹	4π/10 ⁹	4π	
	c/10 ¹⁰	10 ⁻¹⁰			4πc/10 ¹⁰	4π/10 ¹⁰	4π	
	c/10 ⁴	10 ⁻⁴			4πc/10 ⁴	4π/10 ⁴	4π	
	10/c	10	1		10/4πc	10/4π	1/4π	
amp turn	10/c	10	1	1/4π amp turn pra-gilbert	10/4πc	10/4π	1/4π	1/4π
amp turn	10 ⁵ /c	10 ⁵	10 ²	1/4π amp turn pra-ostered	10 ⁵ /4πc	10 ⁵ /4π	1/4π	10 ² /4π
weber/cm ²	10 ⁴ /c	10 ⁴	10 ⁴	weber/m ²	c/10 ⁴	10 ⁻⁴	1	10 ⁴
weber or volt-sec	10 ⁹ /c	10 ⁹	1	weber = volt-sec	c/10 ⁹	10 ⁻⁹	1	1
amp turn weber	10 ⁹ /c ²	10 ⁹	1	1/4π amp turn weber	10 ⁹ /4πc ²	10 ⁹ /4π	1/4π	1/4π
weber	c ² /10 ⁹	10 ⁻⁹	1	weber	4πc ² /10 ⁹	4π/10 ⁹	4π	
amp turn henry	c ² /10 ⁹	10 ⁻⁹	1	1/4π amp turn henry	c ² /10 ⁹	10 ⁻⁹	1	1

1. Multiply number of esu by N to obtain emu
2. Number of emu/number of esu = N
3. Magnitude of 1 esu/magnitude of 1 emu = N

To convert from emu to esu multiply by 1/N;

$$c = 2.998 \times 10^{10}$$

$$1/c = 3.335 \times 10^{-11}$$

$$4\pi = 12.57$$

$$c^2 = 8.988 \times 10^{20}$$

$$1/c^2 = 1.112 \times 10^{-21}$$

$$1/4\pi = 0.7958$$

note: MKS (R) = subrationalized MKS unit

Electromotive force *series of the elements*

element	volts	ion	element	volts	ion
Lithium	2.9595		Tin	0.136	
Rubidium	2.9259		Lead	0.122	Pb ⁺⁺
Potassium	2.9241		Iron	0.045	Fe ⁺⁺⁺
Strontium	2.92		Hydrogen	0.000	
Barium	2.90		Antimony	-0.10	
Calcium	2.87		Bismuth	-0.226	
Sodium	2.7146		Arsenic	-0.30	
Magnesium	2.40		Copper	-0.344	Cu ⁺⁺
Aluminum	1.70		Oxygen	-0.397	
Beryllium	1.69		Polonium	-0.40	
Uranium	1.40		Copper	-0.470	Cu ⁺
Manganese	1.10		Iodine	-0.5345	
Tellurium	0.827		Tellurium	-0.558	Te ⁺⁺⁺⁺
Zinc	0.7618		Silver	-0.7978	
Chromium	0.557		Mercury	-0.7986	
Sulphur	0.51		Lead	-0.80	Pb ⁺⁺⁺⁺
Gallium	0.50		Palladium	-0.820	
Iron	0.441	Fe ⁺⁺	Platinum	-0.863	
Cadmium	0.401		Bromine	-1.0648	
Indium	0.336		Chlorine	-1.3583	
Thallium	0.330		Gold	-1.360	Au ⁺⁺⁺⁺
Cobalt	0.278		Gold	-1.50	Au ⁺
Nickel	0.231		Fluorine	-1.90	

Position of metals in the galvanic series**Corroded end (anodic,
or least noble)**MagnesiumMagnesium alloysZincAluminum 2SCadmiumAluminum 17STSteel or IronCast IronChromium-iron (active)Ni-Resist18-8 Stainless (active)18-8-3 Stainless (active)Lead-tin soldersLeadTinNickel (active)Inconel (active)BrassesCopperBronzesCopper-nickel alloysMonelSilver solderNickel (passive)Inconel (passive)Chromium-iron (passive)18-8 Stainless (passive)18-8-3 Stainless (passive)SilverGraphiteGoldPlatinum**Protected end (cathodic,
or most noble)**

Note: Groups of metals indicate they are closely similar in properties.

Atomic weights

element	symbol	atomic number	atomic weight	element	symbol	atomic number	atomic weight
Aluminum	Al	13	26.97	Molybdenum	Mo	42	95.95
Antimony	Sb	51	121.76	Neodymium	Nd	60	144.27
Argon	A	18	39.944	Neon	Ne	10	20.183
Arsenic	As	33	74.91	Nickel	Ni	28	58.69
Barium	Ba	56	137.36	Nitrogen	N	7	14.008
Beryllium	Be	4	9.02	Osmium	Os	76	190.2
Bismuth	Bi	83	209.00	Oxygen	O	8	16.0000
Boron	B	5	10.82	Palladium	Pd	46	106.7
Bromine	Br	35	79.916	Phosphorus	P	15	30.98
Cadmium	Cd	48	112.41	Platinum	Pt	78	195.23
Calcium	Ca	20	40.08	Potassium	K	19	39.096
Carbon	C	6	12.010	Praseodymium	Pr	59	140.92
Cerium	Ce	58	140.13	Protactinium	Pa	91	231
Cesium	Cs	55	132.91	Radium	Ra	88	226.05
Chlorine	Cl	17	35.457	Radon	Rn	86	222
Chromium	Cr	24	52.01	Rhenium	Re	75	186.31
Cobalt	Co	27	58.94	Rhodium	Rh	45	102.91
Columbium	Cb	41	92.91	Rubidium	Rb	37	85.48
Copper	Cu	29	63.57	Ruthenium	Ru	44	101.7
Dysprosium	Dy	66	162.46	Samarium	Sm	62	150.43
Erbium	Er	68	167.2	Scandium	Sc	21	45.10
Europium	Eu	63	152.0	Selenium	Se	34	78.96
Fluorine	F	9	19.00	Silicon	Si	14	28.06
Gadolinium	Gd	64	156.9	Silver	Ag	47	107.880
Gallium	Ga	31	69.72	Sodium	Na	11	22.997
Germanium	Ge	32	72.60	Strontium	Sr	38	87.63
Gold	Au	79	197.2	Sulfur	S	16	32.06
Hafnium	Hf	72	178.6	Tantalum	Ta	73	180.88
Helium	He	2	4.003	Tellurium	Te	52	127.61
Holmium	Ho	67	164.94	Terbium	Tb	65	159.2
Hydrogen	H	1	1.0080	Thallium	Tl	81	204.39
Indium	In	49	114.76	Thorium	Th	90	232.12
Iodine	I	53	126.92	Thulium	Tm	69	169.4
Iridium	Ir	77	193.1	Tin	Sn	50	118.70
Iron	Fe	26	55.85	Titanium	Ti	22	47.90
Krypton	Kr	36	83.7	Tungsten	W	74	183.92
Lanthanum	La	57	138.92	Uranium	U	92	238.07
Lead	Pb	82	207.21	Vanadium	V	23	50.95
Lithium	Li	3	6.940	Xenon	Xe	54	131.3
Lutecium	Lu	71	174.99	Ytterbium	Yb	70	173.04
Magnesium	Mg	12	24.32	Yttrium	Y	39	88.92
Manganese	Mn	25	54.93	Zinc	Zn	30	65.38
Mercury	Hg	80	200.61	Zirconium	Zr	40	91.22

From the *Journal of the American Chemical Society*, 1943.

Centigrade table of relative humidity or percent of saturation

dry bulb degrees centigrade	difference between readings of wet and dry bulbs in degrees centigrade																																				dry bulb degrees centigrade
	0.5	1.0	1.5	2.0	2.5	3.0	3.5	4.0	4.5	5	6	7	8	9	10	11	12	13	14	15	16	18	20	22	24	26	28	30	32	34	36	38	40				
2	92	83	75	67	59	52	43	36	27	20																										2	
4	93	85	77	70	63	56	48	41	34	28	15																									4	
6	94	87	80	73	66	60	54	47	41	35	23	11																								6	
8	94	87	81	74	68	62	56	50	45	39	28	17																								8	
10	94	88	82	76	71	65	60	54	49	44	34	23	14																							10	
12	94	89	84	78	73	68	63	58	53	48	38	30	21	12	4																					12	
14	95	90	84	79	74	69	65	60	55	51	41	33	24	16	10																					14	
16	95	90	85	81	76	71	67	62	58	54	45	37	29	21	14																					16	
18	95	90	86	82	78	73	69	65	61	57	49	42	35	27	20																					18	
20	96	91	87	82	78	74	70	66	62	58	51	44	36	30	23																					20	
22	96	92	87	83	79	75	72	68	64	60	53	46	40	34	27	21	16	11																		22	
24	96	92	88	85	81	77	74	70	66	63	56	49	43	37	31	26	21	14	10																	24	
26	96	92	89	85	81	77	74	71	67	64	57	51	45	39	34	28	23	18	13																	26	
28	96	92	89	85	82	78	75	72	68	65	59	53	47	42	37	31	26	21	17	13																28	
30	96	93	89	86	82	79	76	73	70	67	61	55	50	44	39	35	30	24	20	16	12															30	
32	96	93	90	86	83	80	77	74	71	68	62	56	51	46	41	36	32	27	23	19	15															32	
34	97	93	90	87	84	81	77	74	71	69	63	58	53	48	43	38	34	30	26	22	18	10														34	
36	97	93	90	87	84	81	78	75	72	70	64	59	54	50	45	41	36	32	28	24	21	13														36	
38	97	94	90	87	84	81	79	76	73	70	65	60	56	51	46	42	38	34	30	26	23	16	10													38	
40	97	94	91	88	85	82	79	76	74	71	66	61	57	52	48	44	40	36	32	29	25	19	13													40	
42	97	94	91	88	85	82	80	77	74	72	67	62	58	53	49	45	41	38	34	31	27	21	15												42		
44	97	94	91	88	86	83	80	77	75	73	68	63	59	54	50	47	43	39	36	32	29	23	17	12												44	
46	97	94	91	89	86	83	81	78	76	73	68	64	60	55	52	48	44	41	37	34	31	25	19	14												46	
48	97	94	92	89	86	84	81	78	76	74	69	65	61	56	53	49	45	42	39	35	33	27	21	16	12											48	
50	97	94	92	89	87	84	82	79	77	75	70	65	62	57	54	50	47	43	40	37	34	28	23	18	14											50	

Reprinted by permission of the Foxboro Company, Foxboro, Mass.

Example: Assume dry bulb reading (thermometer exposed directly to atmosphere) is 20° C and wet bulb reading is 17° C, or a difference of 3° C. The relative humidity at 20° C is then 74%.

continued

Centigrade table of relative humidity or percent of saturation

dry bulb degrees centigrade	difference between readings of wet and dry bulbs in degrees centigrade																																								dry bulb degrees centigrade
	0.5	1.0	1.5	2.0	2.5	3.0	3.5	4.0	4.5	5	6	7	8	9	10	11	12	13	14	15	16	18	20	22	24	26	28	30	32	34	36	38	40								
52	97	94	92	89	87	84	82	79	77	75	70	66	62	58	55	51	48	44	41	38	35	30	25	20	16	11													52		
54	97	95	92	90	87	85	82	80	78	76	71	67	63	59	56	52	49	45	42	39	36	31	26	21	17	13													54		
56	97	95	92	90	87	85	83	80	78	76	72	68	64	60	57	53	50	46	43	40	38	32	27	23	19	15													56		
58	97	95	93	90	88	85	83	80	79	77	72	68	64	61	57	54	51	47	44	42	39	33	29	24	20	16	11	12											58		
60	98	95	93	90	88	86	83	81	79	77	73	69	65	62	58	55	52	48	45	43	40	35	30	26	21	18	14	11											60		
62	98	95	93	91	88	86	84	81	79	78	73	69	66	62	59	56	53	49	46	43	41	36	31	27	23	19	15	12											62		
64	98	95	93	91	88	86	84	82	80	78	74	70	66	63	59	56	53	50	47	44	42	37	32	28	24	20	17	13											64		
66	98	95	93	91	89	86	84	82	80	78	74	70	67	64	60	57	54	51	48	45	43	38	33	29	25	21	18	15	12										66		
68	98	95	93	91	89	87	85	82	81	79	75	71	67	64	61	58	55	52	49	46	44	39	34	30	26	22	19	16	13										68		
70	98	96	93	91	89	87	85	83	81	79	75	71	68	65	61	58	55	52	50	47	44	40	35	31	27	23	20	17	14	11									70		
72	98	96	94	92	89	87	85	83	81	80	76	72	69	65	62	59	56	53	50	48	45	40	36	32	28	24	21	18	15	12									72		
74	98	96	94	92	90	87	85	83	82	80	76	72	69	66	63	60	57	54	51	48	46	41	37	33	29	25	22	19	16	13							11		74		
76	98	96	94	92	90	88	86	84	82	80	76	73	70	66	63	60	57	54	52	49	47	42	38	34	30	26	23	20	17	14	12							12		76	
78	98	96	94	92	90	88	86	84	82	81	77	73	70	67	64	61	58	55	52	50	47	43	38	34	30	27	24	21	18	15	13						10		78		
80	98	96	94	92	90	88	86	84	83	81	77	73	70	67	64	61	58	56	53	50	48	43	39	35	31	28	24	22	19	16	14						11		80		
82	98	96	94	92	90	88	86	84	83	81	77	74	71	68	65	62	59	56	54	51	49	44	40	36	32	29	25	22	20	17	15	12					10		82		
84	98	96	94	92	90	88	86	85	83	81	78	74	71	68	65	62	59	57	54	52	49	45	40	37	33	29	26	23	20	18	16	13							84		
86	98	96	94	92	91	89	87	85	83	82	78	75	72	69	66	63	60	57	55	52	50	45	41	37	34	30	27	24	21	19	16	14	12							86	
88	98	96	95	93	91	89	87	85	83	82	78	75	72	69	66	63	60	58	55	53	51	46	42	38	34	31	28	25	22	19	17	15	13							88	
90	98	97	95	93	91	89	87	85	84	82	79	76	73	69	67	64	61	58	56	53	51	47	42	39	35	32	28	26	23	20	18	16	14							90	
92	98	97	95	93	91	89	87	86	84	82	79	76	73	70	67	64	61	59	56	54	52	47	43	39	36	32	29	26	24	21	19	16	14							92	
94	99	97	95	93	91	89	88	86	84	83	79	76	73	70	67	65	62	59	57	54	52	48	44	40	36	33	30	27	24	22	19	17	15							94	
96	99	97	95	93	91	90	88	86	84	83	80	76	74	70	68	65	62	60	57	55	53	48	44	41	37	34	31	28	25	22	20	18	16							96	
98	99	97	95	93	92	90	88	86	85	83	80	77	74	71	68	65	63	60	58	55	53	49	45	41	38	34	31	28	26	23	21	19	16							98	
100	99	97	95	93	92	90	88	86	85	83	80	77	74	71	68	66	63	60	58	56	54	49	45	42	38	35	32	29	26	24	22	20	19	17						100	

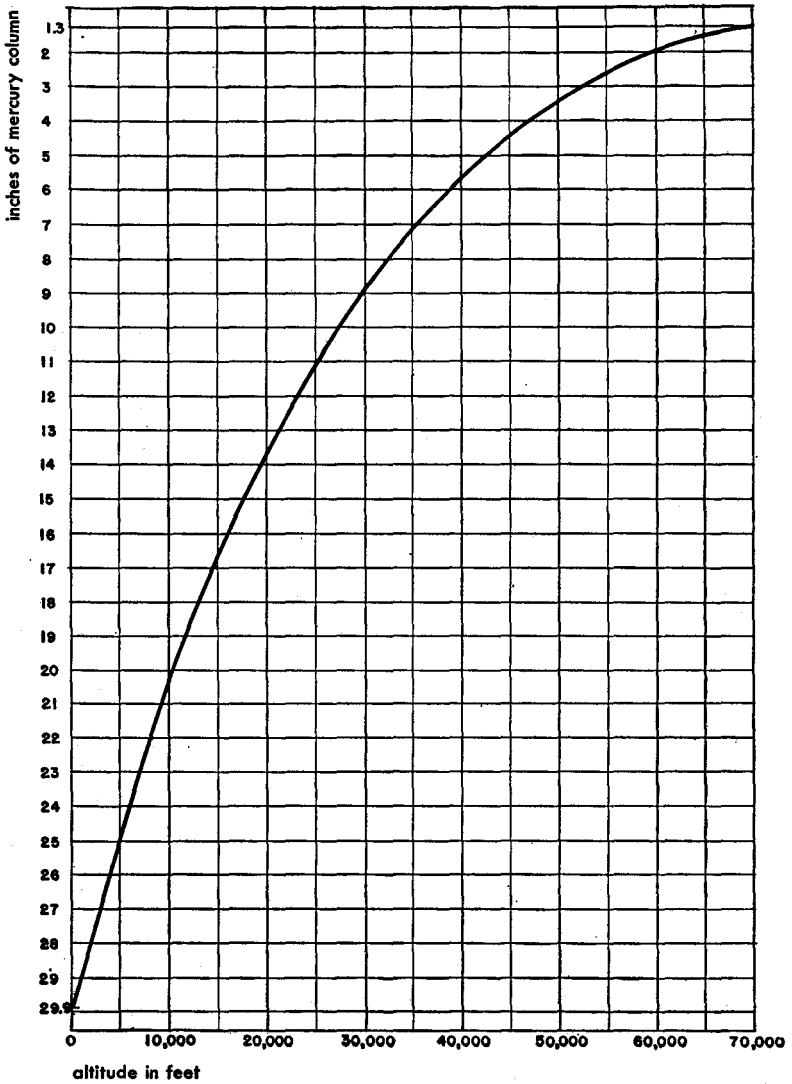
Atmospheric pressure chart

1 inch of mercury = 0.4912 pounds per square inch

Weather data

Compiled from *Climate and Man*, Yearbook of Agriculture, U. S. Dept. of Agriculture, U. S. Govt. Printing Office, Washington, D. C., 1941.

Temperature extremes

United States

Lowest temperature -66° F Riverside Range Station, Wyoming (Feb. 9, 1933)
 Highest temperature 134° F Greenland Ranch, Death Valley, California (July 10, 1933)

Alaska

Lowest temperature -78° F Fort Yukon (Jan. 14, 1934)
 Highest temperature 100° F Fort Yukon

World

Lowest temperature -90° F Verkhoyansk, Siberia (Feb. 5 and 7, 1892)
 Highest temperature 136° F Azizia, Libya, North Africa (Sept. 13, 1922)
 Lowest mean temperature (annual) -14° F Framheim, Antarctica
 Highest mean temperature (annual) 86° F Massawa, Eritrea, Africa

Precipitation extremes

United States

Wettest state Louisiana—average annual rainfall 55.11 inches
 Dryest state Nevada—average annual rainfall 8.81 inches
 Maximum recorded New Smyrna, Fla., Oct. 10, 1924—23.22 inches in 24 hours
 Minimum recorded Bagdad, Calif., 1909-1913—3.93 inches in 5 years
 Greenland Ranch, Calif.—1.35 inches annual average

World

Maximum recorded Cherrapunji, India, Aug. 1841—241 inches in 1 month
 (Average annual rainfall of Cherrapunji is 426 inches)
 Bagui, Luzon, Philippines, July 14-15, 1911—46 inches in 24 hours
 Minimum recorded Wadi Halfa, Anglo-Egyptian Sudan and Awan, Egypt are in the "rainless" area; average annual rainfall is too small to be measured

World temperatures

territory	maximum ° F	minimum ° F	territory	maximum ° F	minimum ° F
NORTH AMERICA			ASIA continued		
Alaska	100	-78	India	120	-19
Canada	103	-70	Iraq	123	19
Canal Zone	97	63	Japan	101	-7
Greenland	86	-46	Malay States	97	66
Mexico	118	11	Philippine Islands	101	58
U. S. A.	134	-66	Siom	106	52
West Indies	102	45	Tibet	85	-20
			Turkey	111	-22
SOUTH AMERICA			U. S. S. R.	109	-90
Argentina	115	-27	AFRICA		
Bolivia	82	25	Algeria	133	1
Brazil	108	21	Anglo-Egyptian Sudan	126	28
Chile	99	19	Angola	91	33
Venezuela	102	45	Belgian Congo	97	34
EUROPE			Egypt	124	31
British Isles	100	4	Ethiopia	111	32
France	107	-14	French Equatorial Africa	118	46
Germany	100	-16	French West Africa	122	41
Iceland	71	-6	Italian Somaliland	93	61
Italy	114	4	Libya	136	35
Norway	95	-26	Morocco	119	5
Spain	124	10	Rhodesia	103	25
Sweden	92	-49	Tunisia	122	28
Turkey	100	17	Union of South Africa	111	21
U. S. S. R.	110	-61	AUSTRALASIA		
ASIA			Australia	127	19
Arabia	114	53	Hawaii	91	51
China	111	-10	New Zealand	94	23
East Indies	101	60	Samoan Islands	96	61
French Indo-China	113	33	Solomon Islands	97	70

World precipitation

territory	highest average				lowest average				yearly average inches
	Jan inches	April inches	July inches	Oct inches	Jan inches	April inches	July inches	Oct inches	
NORTH AMERICA									
Alaska	13.71	10.79	8.51	22.94	.15	.13	.93	.37	43.40
Canada	8.40	4.97	4.07	6.18	.48	.31	1.04	.73	26.85
Canal Zone	3.74	4.30	16.00	15.13	.91	2.72	7.28	10.31	97.54
Greenland	3.46	2.44	3.27	6.28	.35	.47	.91	.94	24.70
Mexico	1.53	1.53	13.44	5.80	.04	.00	.43	.35	29.82
U. S. A.									29.00
West Indies	4.45	6.65	5.80	6.89	.92	1.18	1.53	5.44	49.77
SOUTH AMERICA									
Argentina	6.50	4.72	2.16	3.35	.16	.28	.04	.20	16.05
Bolivia	6.34	1.77	.16	1.42	3.86	1.46	.16	1.30	24.18
Brazil	13.26	12.13	10.47	6.54	2.05	2.63	.91	.05	55.42
Chile	11.78	11.16	16.63	8.88	.00	.00	.03	.00	46.13
Venezuela	2.75	6.90	6.33	10.44	.02	.61	1.87	3.46	40.01
EUROPE									
British Isles	5.49	3.67	3.78	5.57	1.86	1.54	2.38	2.63	36.16
France	3.27	2.64	2.95	4.02	1.46	1.65	.55	2.32	27.48
Germany	1.88	2.79	5.02	2.97	1.16	1.34	2.92	1.82	26.64
Iceland	5.47	3.70	3.07	5.95	5.47	3.70	3.07	5.59	52.91
Italy	4.02	4.41	2.40	5.32	1.44	1.63	.08	2.10	29.74
Norway	8.54	4.13	5.79	8.94	1.06	1.34	1.73	2.48	40.51
Spain	2.83	3.70	2.05	3.58	1.34	1.54	.04	1.77	22.74
Sweden	1.52	1.07	2.67	2.20	.98	.78	1.80	1.60	18.12
Turkey	3.43	1.65	1.06	2.52	3.43	1.65	1.06	2.52	28.86
U. S. S. R.	1.46	1.61	3.50	2.07	.49	.63	.20	.47	18.25
ASIA									
Arabia	1.16	.40	.03	.09	.32	.18	.02	.09	3.05
China	1.97	5.80	13.83	6.92	.15	.61	5.78	.67	50.63
East Indies	18.46	10.67	6.54	10.00	7.48	2.60	.20	.79	78.02
French Indo-China	.79	4.06	12.08	10.61	.52	2.07	9.24	3.67	65.64
India	3.29	33.07	99.52	13.83	.09	.06	.47	.00	75.18
Iraq	1.37	.93	.00	.08	1.17	.48	.00	.05	6.75
Japan	10.79	8.87	9.94	7.48	2.06	2.83	5.02	4.59	70.18
Malay States	9.88	7.64	6.77	8.07	9.88	7.64	6.77	8.07	95.06
Philippine Islands	2.23	1.44	17.28	10.72	.82	1.28	14.98	6.71	83.31
Siam	.33	1.65	6.24	8.32	.33	1.65	6.24	8.32	52.36
Turkey	4.13	2.75	1.73	3.34	2.05	1.73	.21	.93	25.08
U. S. S. R.	1.79	2.05	3.61	4.91	.08	.16	.10	.06	11.85
AFRICA									
Algeria	4.02	2.06	.35	3.41	.52	.11	.00	.05	9.73
Anglo-Egyptian Sudan	.08	4.17	7.87	4.29	.00	.00	.00	.00	18.27
Angola	8.71	5.85	.00	3.80	.09	.63	.00	.09	23.46
Belgian Congo	9.01	6.51	.13	2.77	3.69	1.81	.00	1.88	39.38
Egypt	2.09	.16	.00	.28	.00	.00	.00	.00	3.10
Ethiopia	.59	3.42	10.98	3.39	.28	3.11	8.23	.79	49.17
French Equatorial Africa	9.84	13.42	6.33	13.58	.00	.34	.04	.86	57.55
French West Africa	.10	1.61	8.02	1.87	.00	.00	.18	.00	19.51
Italian Somaliland	.00	3.66	1.67	2.42	.00	3.60	1.67	2.42	17.28
Libya	3.24	.48	.02	1.53	2.74	.18	.00	.67	13.17
Morocco	3.48	2.78	.07	2.47	1.31	.36	.00	.23	15.87
Rhodesia	8.40	.95	.04	1.20	5.81	.65	.00	.88	29.65
Tunisia	2.36	1.30	.08	1.54	2.36	1.30	.08	1.54	15.80
Union of South Africa	6.19	3.79	3.83	5.79	.06	.23	.27	.12	26.07
AUSTRALASIA									
Australia	15.64	5.33	6.57	2.84	.34	.85	.07	.00	28.31
Hawaii	11.77	13.06	9.89	10.97	3.54	2.06	1.04	1.97	82.43
New Zealand	3.34	3.80	5.55	4.19	2.67	2.78	2.99	3.13	43.20
Samoa Islands	18.90	11.26	2.60	7.05	18.90	11.26	2.60	7.05	118.47
Solomon Islands	13.44	8.24	6.26	7.91	13.44	8.24	6.26	7.91	115.37

Principal power supplies in foreign countries

territory	dc volts	ac volts	frequency
NORTH AMERICA			
Alaska		110, 220	60
British Honduras	110, 220		
Canada	110	*110, 150, 115, 230	60, 25
Costa Rica	110	*110	60
Cuba	110, 220	*110, 220	60
Dominican Republic	110	*110, 220	60
Guatemala	220, 125	*110, 220	60, 50
Haiti		110, 220	60, 50
Honduras	110, 220	*110, 220	60
Mexico	110, 220	*110, 125, 115, 220, 230	60, 50
Newfoundland		110, 115	50, 60
Nicaragua	110	*110	60
Panama (Republic)		110, 220	60, 50
Panama (Canal Zone)		110	25
Puerto Rico	110, 220	*110	60
Salvador	110, 220	*110	60
Virgin Islands	110, 220		
WEST INDIES			
Bahamas Is.		115	60
Barbados		110	50
Bermuda		110	60
Curacao		127	50
Jamaica		110	40, 60
Martinique	110	*110	50
Trinidad		110, 220	60
SOUTH AMERICA			
Argentina	*220	*220, 225	50, 60, 43
Bolivia	110	*110, 220	50, 60
Brazil	110, 120, 220	110, 115, 120, 125, 220, 230	50, 60
Chile	220, 110	*220	50, 60
Colombia		*110, 220, 150	60, 50
Ecuador		110, 220	60, 50
Paraguay	*220	220	50
Peru	220, 110	*220, 110	60, 50
Uruguay	220	*220	50
Venezuela	110, 220	*110	50, 60
EUROPE			
Albania	220	*220, 125, 150	50
Austria	220, 110, 150	*220, 120, 127, 110	50
Azores	220	220	50
Belgium	220, 110, 120	*220, 127, 110, 115, 135	50, 40
Bulgaria	220, 120	*220, 120, 150	50
Cyprus (Br.)	*220	110	50
Czechoslovakia	220, 120, 150, 110	*220, 110, 115, 127	50, 42
Denmark	220, 110	*220, 120, 127	50
Estonia	*220, 110	220, 127	50
Finland	*120, 220, 110	220, 120, 115, 110	50
France	110, 220, 120, 125	*110, 115, 120, 125, 220, 230	50, 25
Germany	220, 110, 120, 250	*220, 127, 120, 110	50, 25
Gibraltar	440, 220	*110	76
Greece	*220, 110, 150	*127, 110, 220	50
Hungary	220, 110, 120	*100, 105, 110, 220, 120	42, 50
Iceland		220	50
Irish Free State	*220	*220, 200	50
Italy	110, 125, 150, 220, 250, 160	*150, 125, 120, 110, 115, 260, 220, 135	42, 50, 45
Latvia	220, 110	*220, 120	50
Lithuania	220, 110	*220	50
Malta		105	100
Monaco		110	42
Netherlands	220	220, 120, 127	50
Norway	220	*220, 230, 130, 127, 110, 120, 150	50
Poland	220, 110	*220, 120, 110	50
Portugal	220, 150, 125	*220, 110, 125	50, 42
Rumania	*220, 110, 105, 120	120, 220, 110, 115, 105	50, 42
Russia	220, 110, 120, 115, 250	*120, 110, 220	50
Spain	*110, 120, 115, 105	*120, 125, 150, 110, 115, 220, 130	50
Sweden	220, 110, 120, 115, 250	*220, 127, 110, 125	50, 20, 25
Switzerland	220, 120, 110, 150	*120, 220, 145, 150, 110, 120	50, 40
Turkey	110, 220	*220, 110	50

Principal power supplies in foreign countries *continued*

territory	dc volts	ac volts	frequency
EUROPE <i>continued</i>			
United Kingdom	230, 220, 240	*230, 240, others	50, 25, 40
Jugoslavia	110, 120	*120, 220, 150	50, 42
ASIA			
Arabia		230	50
British Malaya			
Fed. Malay States		230	50, 60, 40
Non-Fed. Malay States	230		
Straits Settlements	*230	230	50
North Borneo		110	60
Ceylon	220	230	50, 60
China	220, 110	*110, 200, 220	50, 60, 25
Hawaii		110, 220	60, 25
India	220, 110, 225, 230, 250	230, 220, 110, others	50, 25
French Indo-China	110, 120, 220, 240	*120, 220, 110, 115, 240	50
Iran (Persia)	220, 110	220	50
Iraq	*220, 200	220, 230	50
Japan	100	*100, 110	50, 60
Manchuria		110	60, 50, 25
Palestine		220	50
Philippine Islands		220	60
Syria		110, 115, 220	50
Siam		100	50
Turkey	220, 110	*220, 110	50
AFRICA			
Angola (Port.)		110	50
Algeria	220	*115, 110, 127	50
Belgian Congo		220	60
British West Africa	*220	230	50
British East Africa	*220	*240, 230, 110, 100	50, 60, 100
Canary Islands	110	*127, 110	50
Egypt	220	200, 110, 220	50, 40
Ethiopia (Abyssinia)		220, 250	50
Italian Africa			
Cyrenaica	150	*110, 150	50
Eritrea		127	50
Libya (Tripoli)		125, 110, 270	50, 42, 45
Somaliland	120	*230	50
Morocco (Fr.)	110	115, 110	50
Morocco (Spanish)	200	*127, 110, 115	50
Madagascar (Fr.)		120	50
Senegal (Fr.)	230	120	50
Tunisia	110	*110, 115, 220	50
Union of South Africa	220, 230, 240, 110	*220, 230, 240	50
OCEANIA			
Australia			
New South Wales	*240	*240	50
Victoria	230	*230	50
Queensland	220, 240	*240	50
South Australia	200, 230, 220	*200, 230, 240	50
West Australia	*220, 110, 230	250	40
Tasmania	230	*240	50
New Zealand	230	*230	50
Fiji Islands	240, 110, 250		50
Society Islands		120	60
Somoa		110	50

Note: Where both ac and dc are available, an asterisk (*) indicates the type of supply and voltage predominating. Where approximately equal quantities of ac and dc are available, an asterisk precedes each of the principal voltages. Voltages and frequencies are listed in order of preference.

The electrical authorities of Great Britain have adopted a plan of unifying electrical distribution systems. The standard potential for both ac and dc supplies will be 230 volts. Systems using other voltages will be changed over. The standard ac frequency will be 50 cycles.

Caution: The listings in these tables represent types of electrical supplies most generally used in particular countries. For power supply characteristics of particular cities of foreign countries, refer to the country section of *World Electrical Markets*, a publication of the U. S. Department of Commerce, Bureau of Foreign and Domestic Commerce, Washington, D. C. In cases where definite information relative to specific locations is necessary, the Electrical Division of the above-named Bureau should be consulted.

World time chart

Aleutian Islands Tulitue, Samoa	Hawaii Islands	Alaska Tahiti	San Francisco & Pacific Coast	Chicago, Central America (except Panama) Mexico, Winnipeg	Bogota, Havana Lima, Montreal New York, Panama	Buenos Aires, Bermuda Santiago, Puerto Rico Lapaz, Atuncion	Rio, Santos Sao Paulo	Iceland Dakar	Algiers, Lisbon London, Paris Madrid	G. C. T.	Bangal, Berlin, Oslo Rome, Tunis, Tripoli Warsaw, Stockholm	Cairo, Capetown Istanbul	Leningrad Moscow	Bombay, Ceylon New Delhi	Chungking Chenglu, Kunming	Cebu, Hong Kong Manila, Shanghai	Chosen, Japan Manchukuo	Brisbane, Guam Melbourne, New Guinea Sydney, Khabarovsk	Solomon Islands New Caledonia	Wellington Auckland
1:00pm	1:30pm	2:00pm	4:00pm	6:00pm	7:00pm	8:00pm	9:00pm	11:00pm	Midnite	0000	1:00am	2:00am	3:00am	5:30am	7:00am	8:00am	9:00am	10:00am	11:00am	11:30am
2:00pm	2:30pm	3:00pm	5:00pm	7:00pm	8:00pm	9:00pm	10:00pm	11:00pm	1:00am	0100	2:00am	3:00am	4:00am	6:30am	8:00am	9:00am	10:00am	11:00am	Noon	12:30pm
3:00pm	3:30pm	4:00pm	6:00pm	8:00pm	9:00pm	10:00pm	11:00pm	1:00am	2:00am	0200	3:00am	4:00am	5:00am	7:30am	9:00am	10:00am	11:00am	Noon	1:00pm	1:30pm
4:00pm	4:30pm	5:00pm	7:00pm	9:00pm	10:00pm	11:00pm	1:00am	2:00am	3:00am	0300	4:00am	5:00am	6:00am	8:30am	10:00am	11:00am	Noon	1:00pm	2:00pm	2:30pm
5:00pm	5:30pm	6:00pm	8:00pm	10:00pm	11:00pm	Midnite	1:00am	3:00am	4:00am	0400	5:00am	6:00am	7:00am	9:30am	11:00am	Noon	1:00pm	2:00pm	3:00pm	3:30pm
6:00pm	6:30pm	7:00pm	9:00pm	11:00pm	Midnite	1:00am	2:00am	4:00am	5:00am	0500	6:00am	7:00am	8:00am	10:30am	Noon	1:00pm	2:00pm	3:00pm	4:00pm	4:30pm
7:00pm	7:30pm	8:00pm	10:00pm	Midnite	1:00am	2:00am	3:00am	5:00am	6:00am	0600	7:00am	8:00am	9:00am	11:30am	1:00pm	2:00pm	3:00pm	4:00pm	5:00pm	5:30pm
8:00pm	8:30pm	9:00pm	11:00pm	1:00am	2:00am	3:00am	4:00am	6:00am	7:00am	0700	8:00am	9:00am	10:00am	12:30pm	2:00pm	3:00pm	4:00pm	5:00pm	6:00pm	6:30pm
9:00pm	9:30pm	10:00pm	Midnite	2:00am	3:00am	4:00am	5:00am	7:00am	8:00am	0800	9:00am	10:00am	11:00am	1:30pm	3:00pm	4:00pm	5:00pm	6:00pm	7:00pm	7:30pm
10:00pm	10:30pm	11:00pm	1:00am	3:00am	4:00am	5:00am	6:00am	8:00am	9:00am	0900	10:00am	11:00am	Noon	2:30pm	4:00pm	5:00pm	6:00pm	7:00pm	8:00pm	8:30pm
11:00pm	11:30pm	Midnite	2:00am	4:00am	5:00am	6:00am	7:00am	9:00am	10:00am	1000	11:00am	Noon	1:00pm	3:30pm	5:00pm	6:00pm	7:00pm	8:00pm	9:00pm	9:30pm
Midnite	12:30am	1:00am	3:00am	5:00am	6:00am	7:00am	8:00am	10:00am	11:00am	1100	Noon	1:00pm	2:00pm	4:30pm	6:00pm	7:00pm	8:00pm	9:00pm	10:00pm	10:30pm
1:00am	1:30am	2:00am	4:00am	6:00am	7:00am	8:00am	9:00am	11:00am	Noon	1200	1:00pm	2:00pm	3:00pm	5:30pm	7:00pm	8:00pm	9:00pm	10:00pm	11:00pm	11:30pm
2:00am	2:30am	3:00am	5:00am	7:00am	8:00am	9:00am	10:00am	Noon	1:00pm	1300	2:00pm	3:00pm	4:00pm	6:30pm	8:00pm	9:00pm	10:00pm	11:00pm	Midnite	12:30am
3:00am	3:30am	4:00am	6:00am	8:00am	9:00am	10:00am	11:00am	1:00pm	2:00pm	1400	3:00pm	4:00pm	5:00pm	7:30pm	9:00pm	10:00pm	11:00pm	Midnite	1:00am	1:30am
4:00am	4:30am	5:00am	7:00am	9:00am	10:00am	11:00am	Noon	2:00pm	3:00pm	1500	4:00pm	5:00pm	6:00pm	8:30pm	10:00pm	11:00pm	Midnite	1:00am	2:00am	2:30am
5:00am	5:30am	6:00am	8:00am	10:00am	11:00am	Noon	1:00pm	3:00pm	4:00pm	1600	5:00pm	6:00pm	7:00pm	9:30pm	11:00pm	Midnite	1:00am	2:00am	3:00am	3:30am
6:00am	6:30am	7:00am	9:00am	11:00am	Noon	1:00pm	2:00pm	4:00pm	5:00pm	1700	6:00pm	7:00pm	8:00pm	10:30pm	Midnite	1:00am	2:00am	3:00am	4:00am	4:30am
7:00am	7:30am	8:00am	10:00am	Noon	1:00pm	2:00pm	3:00pm	5:00pm	6:00pm	1800	7:00pm	8:00pm	9:00pm	11:30pm	1:00am	2:00am	3:00am	4:00am	5:00am	5:30am
8:00am	8:30am	9:00am	11:00am	1:00pm	2:00pm	3:00pm	4:00pm	6:00pm	7:00pm	1900	8:00pm	9:00pm	10:00pm	12:30am	2:00am	3:00am	4:00am	5:00am	6:00am	6:30am
9:00am	9:30am	10:00am	Noon	2:00pm	3:00pm	4:00pm	5:00pm	7:00pm	8:00pm	2000	9:00pm	10:00pm	11:00pm	1:30am	3:00am	4:00am	5:00am	6:00am	7:00am	7:30am
10:00am	10:30am	11:00am	1:00pm	3:00pm	4:00pm	5:00pm	6:00pm	8:00pm	9:00pm	2100	10:00pm	11:00pm	Midnite	2:30am	4:00am	5:00am	6:00am	7:00am	8:00am	8:30am
11:00am	11:30am	Noon	2:00pm	4:00pm	5:00pm	6:00pm	7:00pm	9:00pm	10:00pm	2200	11:00pm	Midnite	1:00am	3:30am	5:00am	6:00am	7:00am	8:00am	9:00am	9:30am
Noon	12:30pm	1:00pm	3:00pm	5:00pm	6:00pm	7:00pm	8:00pm	10:00pm	11:00pm	2300	Midnite	1:00am	2:00am	4:30am	6:00am	7:00am	8:00am	9:00am	10:00am	10:30am
1:00pm	1:30pm	2:00pm	4:00pm	6:00pm	7:00pm	8:00pm	9:00pm	11:00pm	Midnite	2400	1:00am	2:00am	3:00am	5:30am	7:00am	8:00am	9:00am	10:00am	11:00am	11:30am

This chart is based on STANDARD TIME.
Passing heavy line denotes change of date.

When passing the line going to the right ADD one day.
When passing the line going to left SUBTRACT one day.

Courtesy, American Cable & Radio Corporation

Electromagnetic Frequency Spectrum

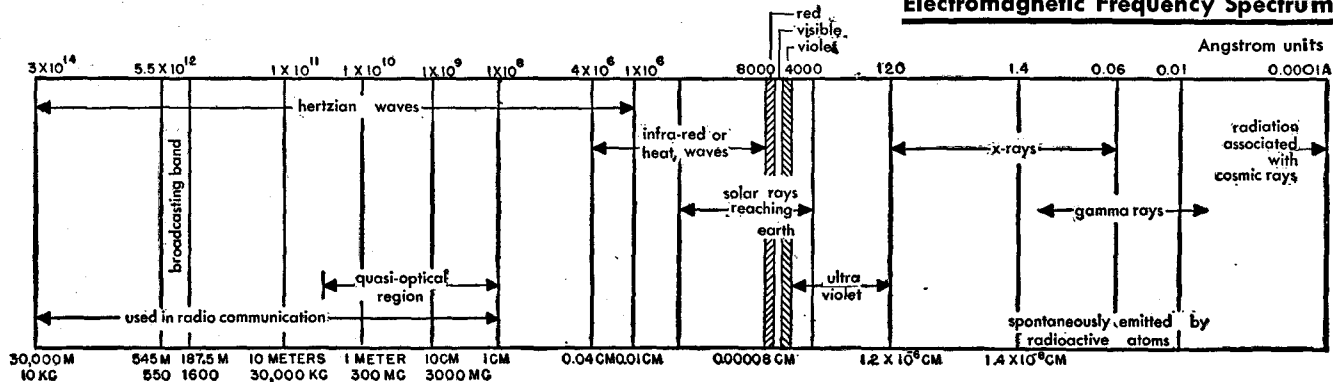

Radio frequency classifications

frequency in kilocycles	designations* †	abbreviations	wavelength in meters†	wavelength in feet†
10- 30	Very Low	VLF	30,000 - 10,000	98,424 - 32,808
30- 300	Low	LF	10,000 - 1,000	32,808 - 3,281
300- 3,000	Medium	MF	1,000 - 100	3,281 - 328
3,000- 30,000	High	HF	100 - 10	328 - 32.8
30,000- 300,000	Very High	VHF	10 - 1	32.8 - 3.28
300,000- 3,000,000	Ultra High	UHF	1 - 0.1	3.28- 0.33
3,000,000- 30,000,000	Super High	SHE	0.1- 0.01	0.33- 0.03

* Official FCC designation, March 2, 1943.

† Based on the established practice of considering the velocity of propagation in air as 300,000 kilometers per second instead of the true velocity of propagation of 299,796 kilometers per second.

Wavelength vs frequency chart

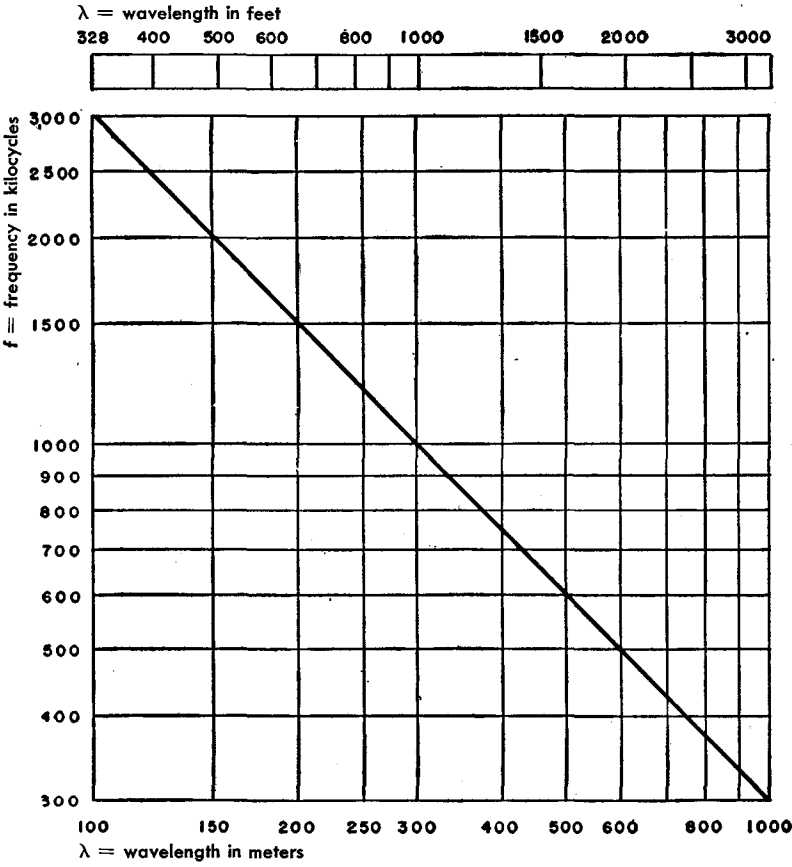

Conversion factors for wavelength vs frequency chart

for frequencies from	multiply f by	multiply λ by
30- 300 kilocycles	0.1	10.0
300- 3,000 kilocycles	1.0	1.0
3,000- 30,000 kilocycles	10.0	0.1
30,000- 300,000 kilocycles	100.0	0.01
300,000- 3,000,000 kilocycles	1,000.0	0.001
3,000,000-30,000,000 kilocycles	10,000.0	0.0001

Wavelength vs frequency formulas

Wavelength in meters, $\lambda_m = \frac{300,000}{\text{frequency in kilocycles}}$

Wavelength in feet, $\lambda_{ft} = \frac{300,000 \times 3.28}{\text{frequency in kilocycles}}$

30
50
520K c 6025 m
25 up
.02
.01
.01

Frequency tolerances

Cairo revision 1938

frequency bands (wavelengths)	column 1	column 2
A. From 10 to 550 kc (30,000 to 545 meters):		
a. Fixed stations	0.1%	0.1%
b. Land stations	0.1%	0.1%
c. Mobile stations using frequencies other than those of bands indicated under (d)	0.5%	0.1%
d. Mobile stations using frequencies of the bands 110-160 kc (2,727 to 1,875 meters), 365-515 kc (822 to 583 meters) †	0.5%*	0.3%*
e. Aircraft stations	0.5%	0.3%
f. Broadcasting stations	50 cycles	20 cycles
B. From 550 to 1,500 kc (545 to 200 meters):		
a. Broadcasting stations	50 cycles	20 cycles
b. Land stations	0.1%	0.05%
c. Mobile stations using the frequency of 1,364 kc (220 meters)	0.5%	0.1%
C. From 1,500 to 6,000 kc (200 to 50 meters):		
a. Fixed stations	0.03%	0.01%
b. Land stations	0.04%	0.02%
c. Mobile stations using frequencies other than those of bands indicated in (d):		
1,560 to 4,000 kc (192.3 to 75 meters)	0.1%*	0.05%*
4,000 to 6,000 kc (75 to 50 meters)	0.04%	0.02%
d. Mobile stations using frequencies within the bands:		
4,115 to 4,165 kc (72.90 to 72.03 meters) }	0.1%*	0.05%*
5,500 to 5,550 kc (54.55 to 54.05 meters) }	0.05%	0.025%
e. Aircraft stations	0.05%	0.025%
f. Broadcasting:		
between 1,500 and 1,600 kc (200 and 187.5 meters)	50 cycles	20 cycles
between 1,600 and 6,000 kc (187.5 and 50 meters)	0.01%	0.005%
D. From 6,000 to 30,000 kc (50 to 10 meters):		
a. Fixed stations	0.02%	0.01%
b. Land stations	0.04%	0.02%
c. Mobile stations using frequencies other than those of bands indicated under (d)	0.04%	0.02%
d. Mobile stations using frequencies within the bands:		
6,200 to 6,250 kc (48.39 to 48 meters) }	0.1%*	0.05%*
8,230 to 8,330 kc (36.45 to 36.01 meters) }		
11,000 to 11,100 kc (27.27 to 27.03 meters) }		
12,340 to 12,500 kc (24.31 to 24 meters) }		
16,460 to 16,660 kc (18.23 to 18.01 meters) }		
22,000 to 22,200 kc (13.64 to 13.51 meters) }		
e. Aircraft stations	0.05%	0.025%
f. Broadcasting stations	0.01%	0.005%

Column 1: Transmitters in service now and until January 1, 1944, after which date they will conform to the tolerances indicated in column 2.

Column 2: New transmitters installed beginning January 1, 1940.

* See preamble, under 3.

† It is recognized that a great number of spark transmitters and simple self-oscillator transmitters exist in this service which are not able to meet these requirements.

Frequency tolerances *continued*

The frequency tolerance is the maximum permissible separation between the actual frequency of an emission and the frequency which this emission should have (frequency notified or frequency chosen by the operator).

This separation results from the following errors:

- a. Error made when the station was calibrated; this error presents a semi-permanent character.
- b. Error made during use of the station (error variable from one transmission to another and resulting from actual operating conditions: ambient temperature, voltage of supply, antenna, skill of the operator, et cetera). This error, which is usually small in other services, is particularly important in the case of mobile stations.
- c. Error due to slow variations of the frequency of the transmitter during a transmission.

Note: In the case of transmissions without a carrier wave, the preceding definition applies to the frequency of the carrier wave before its suppression.

In the case of ship stations, the reference frequency is the frequency on which the transmission begins, and the figures appearing in the present table, marked by an asterisk, refer only to frequency separations observed during a ten-minute period of transmission.

In the frequency tolerance, modulation is not considered.

Note 1: The administrations shall endeavor to profit by the progress of the art in order to reduce frequency tolerances progressively.

Note 2: It shall be understood that ship stations working in shared bands must observe the tolerances applicable to land stations and must conform to article 7, paragraph 21 (2) (a). [No. 186.]

Note 3: Radiotelephone stations with less than 25 watts power, employed by maritime beacons for communications with beacons isolated at sea, shall be comparable, with reference to frequency stability, to mobile stations indicated in C above.

Note 4: Ships equipped with a transmitter, the power of which is under 100 watts, working in the band of 1560-4000 kc (192.3-75 meters), shall not be subject to the stipulations of column 1.

Reproduced from "Treaty Series No. 948, Telecommunication—General Radio Regulations (Cairo Revision, 1938) and Final Radio Protocol (Cairo Revision, 1938) annexed to the Telecommunication Convention (Madrid, 1932) Between the United States of America and Other Powers," Appendix 1, pp. 234, 235 and 236, United States Government Printing Office, Washington, D. C. References refer to this publication.

Frequency-band widths occupied by the emissions Cairo revision, 1938*

The frequency bands necessary for the various types of transmission, at the present state of technical development, are indicated below. This table is based solely upon *amplitude* modulation. For frequency or phase modulation, the band widths necessary for the various transmissions are many times greater.

type of transmission	total width of the band in cycles for transmission with two sidebands
A0 Continuous waves, no signaling	
A1 Telegraphy, pure, continuous wave Morse code Baudot code Stop-start printer Scanning-type printer	Numerically equal to the telegraph speed in bauds for the fundamental frequency, 3 times this width for the 3d harmonic, etc. [For a code of 8 time elements (dots or blanks) per letter and 48 time elements per word, the speed in bauds shall be equal to 0.8 times the speed in words per minute.] 300-1,000, for speeds of 50 words per minute, according to the conditions of operation and the number of lines scanned (for example, 7 or 12). (Harmonics are not considered in the above values.)
A2 Telegraphy modulated to musical frequency	Figures appearing under A1, plus twice the highest modulation frequency.
A3 Commercial radiotelephony Broadcasting	Twice the number indicated by the C.C.I.F. Opinions (about 6,000 to 8,000). ¹ 15,000 to 20,000.
A4 Facsimile	Approximately the ratio between the number of picture components ² to be transmitted and the number of seconds necessary for the transmission.
A5 Television	Approximately the product of the number of picture components ² multiplied by the number of pictures transmitted per second.

¹ It is recognized that the band width may be wider for multiple-channel radiotelephony and secret radiotelephony.

² Two picture components, one black and one white, constitute a cycle; thus, the modulation frequency equals one half the number of components transmitted per second.

* See Footnote under Frequency Tolerances, Treaty Series No. 948, Telecommunication.

Tolerances for the intensity of harmonics

of fixed, land, and broadcasting stations¹ Cairo revision, 1938*

frequency bands	tolerances
Frequency under 3,000 kc (wavelength above 100 meters)	The field intensity produced by any harmonic must be under 300 $\mu\text{v}/\text{m}$ at 5 kilometers from the transmitting antenna.
Frequency above 3,000 kc (wavelength under 100 meters)	The power of a harmonic in the antenna must be 40 db under the power of the fundamental, but in no case may it be above 200 milliwatts. ²

¹ With regard to tolerances for mobile stations, an attempt shall be made to achieve, so far as possible, the figures specified for fixed stations.

² A transmitter, the harmonic intensity of which is not above the figures specified but which nevertheless causes interference, must be subjected to special measures intended to eliminate such interference.

* See Footnote under Frequency Tolerances, Treaty Series No. 948, Telecommunication

Classification of emissions Cairo revision, 1938 *

1. Emissions shall be classified below according to the purpose for which they are used, assuming their modulation or their possible keying to be only in amplitude.

a. Continuous waves:

Type A0. Waves the successive oscillations of which are identical under fixed conditions.¹

Type A1. Telegraphy on pure continuous waves. A continuous wave which is keyed according to a telegraph code.

Type A2. Modulated telegraphy. A carrier wave modulated at one or more audible frequencies, the audible frequency or frequencies or their combination with the carrier wave being keyed according to a telegraph code.

Type A3. Telephony. Waves resulting from the modulation of a carrier wave by frequencies corresponding to the voice, to music, or to other sounds.

Type A4. Facsimile. Waves resulting from the modulation of a carrier wave by frequencies produced at the time of the scanning of a fixed image with a view to its reproduction in a permanent form.

Type A5. Television. Waves resulting from the modulation of a carrier wave by frequencies produced at the time of the scanning of fixed or moving objects.²

Note: The band widths to which these emissions correspond are indicated under Frequency-Band Widths Occupied by the Emissions.

b. Damped waves:

Type B. Waves composed of successive series of oscillations the amplitude of which, after attaining a maximum, decreases gradually, the wave trains being keyed according to a telegraph code.

2. In the above classification, the presence of a carrier wave is assumed in all cases. However, such carrier wave may or may not be transmitted. This classification does not contemplate exclusion of the use, by the administrations concerned, under specified conditions, of types of waves not included in the foregoing definitions.

3. Waves shall be indicated first by their frequency in kilocycles per second (kc) or in megacycles per second (Mc). Following this indication, there shall be given, in parentheses, the approximate length in meters. In the present Regulations, the approximate value of the wavelength in meters is the quotient of the number 300,000 divided by the frequency expressed in kilocycles per second.

¹ These waves are used only in special cases, such as standard frequency emissions.

² Objects is used here in the optical sense of the word.

*See Footnote under Frequency Tolerances, Treaty Series No. 948, Telecommunication.

Relation between decibels and power, voltage, and current ratios

The decibel, abbreviated db, is a unit used to express the ratio between two amounts of power, P_1 and P_2 , existing at two points.

By definition the number of db = $10 \log_{10} \frac{P_1}{P_2}$

It is also used to express voltage and current ratios.

The number of db = $20 \log_{10} \frac{V_1}{V_2} = 20 \log_{10} \frac{I_1}{I_2}$

Strictly, it can be used to express voltage and current ratios only when the two points at which the voltages or currents in question have identical impedances.

power ratio	voltage and current ratio	decibels	power ratio	voltage and current ratio	decibels
1.0233	1.0116	0.1	19.953	4.4668	13.0
1.0471	1.0233	0.2	25.119	5.0119	14.0
1.0715	1.0351	0.3	31.623	5.6234	15.0
1.0965	1.0471	0.4	39.811	6.3096	16.0
1.1220	1.0593	0.5	50.119	7.0795	17.0
1.1482	1.0715	0.6	63.096	7.9433	18.0
1.1749	1.0839	0.7	79.433	8.9125	19.0
1.2023	1.0965	0.8	100.00	10.0000	20.0
1.2303	1.1092	0.9	158.49	12.589	22.0
1.2589	1.1220	1.0	251.19	15.849	24.0
1.3183	1.1482	1.2	398.11	19.953	26.0
1.3804	1.1749	1.4	630.96	25.119	28.0
1.4454	1.2023	1.6	1000.0	31.623	30.0
1.5136	1.2303	1.8	1584.9	39.811	32.0
1.5849	1.2589	2.0	2511.9	50.119	34.0
1.6595	1.2882	2.2	3981.1	63.096	36.0
1.7378	1.3183	2.4	6309.6	79.433	38.0
1.8197	1.3490	2.6	10^4	100.000	40.0
1.9055	1.3804	2.8	$10^4 \times 1.5849$	125.89	42.0
1.9953	1.4125	3.0	$10^4 \times 2.5119$	158.49	44.0
2.2387	1.4962	3.5	$10^4 \times 3.9811$	199.53	46.0
2.5119	1.5849	4.0	$10^4 \times 6.3096$	251.19	48.0
2.8184	1.6788	4.5	10^5	316.23	50.0
3.1623	1.7783	5.0	$10^5 \times 1.5849$	398.11	52.0
3.5481	1.8836	5.5	$10^5 \times 2.5119$	501.19	54.0
3.9811	1.9953	6.0	$10^5 \times 3.9811$	630.96	56.0
5.0119	2.2387	7.0	$10^5 \times 6.3096$	794.33	58.0
6.3096	2.5119	8.0	10^6	1,000.00	60.0
7.9433	2.8184	9.0	10^7	3,162.3	70.0
10.0000	3.1623	10.0	10^8	10,000.0	80.0
12.589	3.5481	11.0	10^9	31,623	90.0
15.849	3.9811	12.0	10^{10}	100,000	100.0

To convert

Decibels to nepers multiply by 0.1151

Nepers to decibels multiply by 8.686

Where the power ratio is less than unity, it is usual to invert the fraction and express the answer as a decibel loss.

■ Engineering and material data

Copper-wire table—standard annealed copper

American wire gauge (B & S)*

gauge no	diam-eter, mils	cross section		ohms per 1,000 ft at 20° C (68° F)	lb per 1,000 ft	ft per lb	ft per ohm at 20° C (68° F)	ohms per lb at 20° C (68° F)
		circular mils	square inches					
0000	460.0	211,600	0.1662	0.04901	640.5	1.561	20,400	0.00007652
000	409.6	167,800	0.1318	0.06180	507.9	1.968	16,180	0.0001217
00	364.8	133,100	0.1045	0.07793	402.8	2.482	12,830	0.0001935
0	324.9	105,500	0.08289	0.09827	319.5	3.130	10,180	0.0003076
1	289.3	83,690	0.06573	0.1239	253.3	3.947	8,070	0.0004891
2	257.6	66,370	0.05213	0.1563	200.9	4.977	6,400	0.0007778
3	229.4	52,640	0.04134	0.1970	159.3	6.276	5,075	0.001237
4	204.3	41,740	0.03278	0.2485	126.4	7.914	4,025	0.001966
5	181.9	33,100	0.02600	0.3133	100.2	9.980	3,192	0.003127
6	162.0	26,250	0.02062	0.3951	79.46	12.58	2,531	0.004972
7	144.3	20,820	0.01635	0.4982	63.02	15.87	2,007	0.007905
8	128.5	16,510	0.01297	0.6282	49.98	20.01	1,592	0.01257
9	114.4	13,090	0.01028	0.7921	39.63	25.23	1,262	0.01999
10	101.9	10,380	0.008155	0.9989	31.43	31.82	1,001	0.03178
11	90.74	8,234	0.006467	1.260	24.92	40.12	794	0.05053
12	80.81	6,530	0.005129	1.588	19.77	50.59	629.6	0.08035
13	71.96	5,178	0.004067	2.003	15.68	63.80	499.3	0.1278
14	64.08	4,107	0.003225	2.525	12.43	80.44	396.0	0.2032
15	57.07	3,257	0.002558	3.184	9.858	101.4	314.0	0.3230
16	50.82	2,583	0.002028	4.016	7.818	127.9	249.0	0.5136
17	45.26	2,048	0.001609	5.064	6.200	161.3	197.5	0.8167
18	40.30	1,624	0.001276	6.385	4.917	203.4	156.6	1.299
19	35.89	1,288	0.001012	8.051	3.899	256.5	124.2	2.065
20	31.96	1,022	0.0008023	10.15	3.092	323.4	98.50	3.283
21	28.46	810.1	0.0006363	12.80	2.452	407.8	78.11	5.221
22	25.35	642.4	0.0005046	16.14	1.945	514.2	61.95	8.301
23	22.57	509.5	0.0004002	20.36	1.542	648.4	49.13	13.20
24	20.10	404.0	0.0003173	25.67	1.223	817.7	38.96	20.99
25	17.90	320.4	0.0002517	32.37	0.9699	1,031.0	30.90	33.37
26	15.94	254.1	0.0001996	40.81	0.7692	1,300	24.50	53.06
27	14.20	201.5	0.0001583	51.47	0.6100	1,639	19.43	84.37
28	12.64	159.8	0.0001255	64.90	0.4837	2,067	15.41	134.2
29	11.26	126.7	0.00009953	81.83	0.3836	2,607	12.22	213.3
30	10.03	100.5	0.00007894	103.2	0.3042	3,287	9.691	339.2
31	8.928	79.70	0.00006260	130.1	0.2413	4,145	7.685	539.3
32	7.950	63.21	0.00004964	164.1	0.1913	5,227	6.095	857.6
33	7.080	50.13	0.00003937	206.9	0.1517	6,591	4.833	1,364
34	6.305	39.75	0.00003122	260.9	0.1203	8,310	3.833	2,168
35	5.615	31.52	0.00002476	329.0	0.09542	10,480	3.040	3,448
36	5.000	25.00	0.00001964	414.8	0.07568	13,210	2.411	5,482
37	4.453	19.83	0.00001557	523.1	0.06001	16,660	1.912	8,717
38	3.965	15.72	0.00001235	659.6	0.04759	21,010	1.516	13,860
39	3.531	12.47	0.000009793	831.8	0.03774	26,500	1.202	22,040
40	3.145	9.888	0.000007766	1,049.0	0.02993	33,410	0.9534	35,040

Temperature coefficient of resistance:

The resistance of a conductor at temperature $t^{\circ}\text{C}$ is given by

$$R_t = R_{20} [1 + \alpha_{20}(t - 20)]$$

where R_{20} is the resistance at 20°C and α_{20} is the temperature coefficient of resistance at 20°C .

For copper, $\alpha_{20} = 0.00393$. That is, the resistance of a copper conductor increases approximately 4/10 of 1 percent per degree centigrade rise in temperature.

* For additional data on wire, see pages 36, 37, 38, 60, and 126.

Copper-wire table—English and metric units†

Amer wire gauge AWG (B&S)	Birm wire gauge BWG	imperial or British std SWG (NBS)	English units			metric units		
			diam in inches	weight lbs per wire mile	resistance ohms per wire mile 20° C (68° F)	diam in mm	weight kg per wire km	resistance ohms per wire km 20° C (68° F)
—	—	—	.1968	618	1.415	5.0	174.0	.879
—	—	—	.1940	600	1.458	4.928	169.1	.905
—	—	6	.1920	589.2	1.485	4.875	166.2	.922
—	—	—	.1855	550	1.590	4.713	155.2	.987
5	—	—	.1819	528.9	1.654	4.620	149.1	1.028
—	7	—	.1800	517.8	1.690	4.575	146.1	1.049
—	—	—	.1771	500	1.749	4.5	141.2	1.086
—	—	7	.1762	495.1	1.769	4.447	140.0	1.098
—	—	—	.1679	450	1.945	4.260	127.1	1.208
—	8	—	.1650	435.1	2.011	4.190	123.0	1.249
6	—	—	.1620	419.5	2.086	4.115	118.3	1.296
—	—	8	.1600	409.2	2.139	4.062	115.3	1.328
—	—	—	.1582	400	2.187	4.018	113.0	1.358
—	—	—	.1575	395.3	2.213	4.0	111.7	1.373
—	9	—	.1480	350.1	2.500	3.760	98.85	1.552
7	—	—	.1443	332.7	2.630	3.665	93.78	1.634
—	—	9	.1440	331.4	2.641	3.658	93.40	1.641
—	—	—	.1378	302.5	2.892	3.5	85.30	1.795
—	—	—	.1370	300	2.916	3.480	84.55	1.812
—	10	—	.1341	287.0	3.050	3.405	80.95	1.893
8	—	—	.1285	263.8	3.317	3.264	74.37	2.061
—	—	10	.1280	261.9	3.342	3.252	73.75	2.077
—	—	—	.1251	250	3.500	3.180	70.50	2.173
—	—	—	.1181	222.8	3.930	3.0	62.85	2.440
9	—	—	.1144	209.2	4.182	2.906	58.98	2.599
—	—	—	.1120	200	4.374	2.845	56.45	2.718
—	12	—	.1090	189.9	4.609	2.768	53.50	2.862
—	—	12	.1040	172.9	5.063	2.640	48.70	3.144
*10	—	—	.1019	165.9	5.274	2.588	46.77	3.277
—	—	—	.0984	154.5	5.670	2.5	43.55	3.520
—	—	—	.0970	150	5.832	2.460	42.30	3.620
—	*14	—	.0830	110.1	7.949	2.108	31.03	4.930
*12	—	—	.0808	104.4	8.386	2.053	29.42	5.211
—	—	14	.0801	102.3	8.556	2.037	28.82	5.315
—	—	—	.0788	99.10	8.830	2.0	27.93	5.480
*13	—	—	.0720	82.74	10.58	1.828	23.33	6.571
*14	—	—	.0641	65.63	13.33	1.628	18.50	8.285
*16	—	—	.0508	41.28	21.20	1.291	11.63	13.17
*17	—	—	.0453	32.74	26.74	1.150	9.23	16.61
*18	—	—	.0403	25.98	33.71	1.024	7.32	20.95
*19	—	—	.0359	20.58	42.51	.912	5.802	26.42
*22	—	—	.0253	10.27	85.24	.644	2.894	52.96
*24	—	—	.0201	6.46	135.5	.511	1.820	84.21
*26	—	—	.0159	4.06	215.5	.405	1.145	133.9
*27	—	—	.0142	3.22	271.7	.361	.908	168.9
*28	—	—	.0126	2.56	342.7	.321	.720	212.9

* When used in cable, weight and resistance of wire should be increased about 3% to allow for increase due to twist.

† For additional data on wire, see pages 35, 37, 38, 60, and 126.

Solid copperweld wire—mechanical and electrical properties

size AWG	diam inch	cross section area		weight			resistance ohms/1000 ft at 68° F		breaking load, pounds		attenuation—db per mile*				characteristic impedance ²	
		circular mils	square inch	pounds per 1000 feet	pounds per mile	feet per pound	40%	30%	40% conduct	30% conduct	40% cond		30% cond		40%	30%
											dry	wet	dry	wet		
4	.2043	41,740	.03278	115.8	611.6	8.63	0.6337	0.8447	3,541	3,934	—	—	—	—	—	—
5	.1819	33,100	.02600	91.86	485.0	10.89	0.7990	1.065	2,938	3,250	—	—	—	—	—	—
6	.1620	26,250	.02062	72.85	384.6	13.73	1.008	1.343	2,433	2,680	.078	.086	.103	.109	650	686
7	.1443	20,820	.01635	57.77	305.0	17.31	1.270	1.694	2,011	2,207	.093	.100	.122	.127	685	732
8	.1285	16,510	.01297	45.81	241.9	21.83	1.602	2.136	1,660	1,815	.111	.118	.144	.149	727	787
9	.1144	13,090	.01028	36.33	191.8	27.52	2.020	2.693	1,368	1,491	.132	.138	.169	.174	776	852
10	.1019	10,380	.008155	28.81	152.1	34.70	2.547	3.396	1,130	1,231	.156	.161	.196	.200	834	920
11	.0907	8,234	.006467	22.85	120.6	43.76	3.212	4.28	896	975	.183	.188	.228	.233	910	1,013
12	.0808	6,530	.005129	18.12	95.68	55.19	4.05	5.40	711	770	.216	.220	.262	.266	1,000	1,120
13	.0720	5,178	.004067	14.37	75.88	69.59	5.11	6.81	490	530	—	—	—	—	—	—
14	.0641	4,107	.003225	11.40	60.17	87.75	6.44	8.59	400	440	—	—	—	—	—	—
15	.0571	3,257	.002558	9.038	47.72	110.6	8.12	10.83	300	330	—	—	—	—	—	—
16	.0508	2,583	.002028	7.167	37.84	139.5	10.24	13.65	250	270	—	—	—	—	—	—
17	.0453	2,048	.001609	5.684	30.01	175.9	12.91	17.22	185	205	—	—	—	—	—	—
18	.0403	1,624	.001276	4.507	23.80	221.9	16.28	21.71	153	170	—	—	—	—	—	—
19	.0359	1,288	.001012	3.575	18.87	279.8	20.53	27.37	122	135	—	—	—	—	—	—
20	.0320	1,022	.0008023	2.835	14.97	352.8	25.89	34.52	100	110	—	—	—	—	—	—
21	.0285	810.1	.0006363	2.248	11.87	444.8	32.65	43.52	73.2	81.1	—	—	—	—	—	—
22	.0253	642.5	.0005046	1.783	9.413	560.9	41.17	54.88	58.0	64.3	—	—	—	—	—	—
23	.0226	509.5	.0004002	1.414	7.465	707.3	51.92	69.21	46.0	51.0	—	—	—	—	—	—
24	.0201	404.0	.0003173	1.121	5.920	891.9	65.46	87.27	36.5	40.4	—	—	—	—	—	—
25	.0179	320.4	.0002517	0.889	4.695	1,125	82.55	110.0	28.9	32.1	—	—	—	—	—	—
26	.0159	254.1	.0001996	0.705	3.723	1,418	104.1	138.8	23.0	25.4	—	—	—	—	—	—
27	.0142	201.5	.0001583	0.559	2.953	1,788	131.3	175.0	18.2	20.1	—	—	—	—	—	—
28	.0126	159.8	.0001255	0.443	2.342	2,255	165.5	220.6	14.4	15.9	—	—	—	—	—	—
29	.0113	126.7	.0000995	0.352	1.857	2,843	208.7	278.2	11.4	12.6	—	—	—	—	—	—
30	.0100	100.5	.0000789	0.279	1.473	3,586	263.2	350.8	9.08	10.0	—	—	—	—	—	—
31	.0089	79.70	.0000626	0.221	1.168	4,521	331.9	442.4	7.20	7.95	—	—	—	—	—	—
32	.0080	63.21	.0000496	0.175	0.926	5,701	418.5	557.8	5.71	6.30	—	—	—	—	—	—
33	.0071	50.13	.0000394	0.139	0.734	7,189	527.7	703.4	4.53	5.00	—	—	—	—	—	—
34	.0063	39.75	.0000312	0.110	0.582	9,065	665.4	887.0	3.59	3.97	—	—	—	—	—	—
35	.0056	31.52	.0000248	0.087	0.462	11,430	839.0	1,119	2.85	3.14	—	—	—	—	—	—
36	.0050	25.00	.0000196	0.069	0.366	14,410	1,058	1,410	2.26	2.49	—	—	—	—	—	—
37	.0045	19.83	.0000156	0.055	0.290	18,180	1,334	1,778	1.79	1.98	—	—	—	—	—	—
38	.0040	15.72	.0000123	0.044	0.230	22,920	1,682	2,243	1.42	1.57	—	—	—	—	—	—
39	.0035	12.47	.00000979	0.035	0.183	28,900	2,121	2,828	1.13	1.24	—	—	—	—	—	—
40	.0031	9.89	.00000777	0.027	0.145	36,440	2,675	3,566	0.893	0.986	—	—	—	—	—	—

Note: Copperweld wire in sizes from No. 25 to No. 40 may be difficult to obtain at present due to a shortage of facilities for making these smaller sizes.

* DP Insulators, 12-inch Wire Spacing, 1000 cycles

For additional information on wire, see pages 35, 36, 38, 40, and 126.

Standard stranded copper conductors

American wire gauge

circular mils	size AWG	number of wires	individual wire diam inches	cable diam inches	area square inches	weight lbs per 1000 ft	weight lbs per mile	*maximum resistance ohms/1000 ft at 20° C
211,600	4/0	19	.1055	.528	0.1662	653.3	3,450	0.05093
167,800	3/0	19	.0940	.470	0.1318	518.1	2,736	0.06422
133,100	2/0	19	.0837	.419	0.1045	410.9	2,170	0.08097
105,500	1/0	19	.0745	.373	0.08286	325.7	1,720	0.1022
83,690	1	19	.0664	.332	0.06573	258.4	1,364	0.1288
66,370	2	7	.0974	.292	0.05213	204.9	1,082	0.1624
52,640	3	7	.0867	.260	0.04134	162.5	858.0	0.2048
41,740	4	7	.0772	.232	0.03278	128.9	680.5	0.2582
33,100	5	7	.0688	.206	0.02600	102.2	539.6	0.3256
26,250	6	7	.0612	.184	0.02062	81.05	427.9	0.4105
20,820	7	7	.0545	.164	0.01635	64.28	339.4	0.5176
16,510	8	7	.0486	.146	0.01297	50.98	269.1	0.6528
13,090	9	7	.0432	.130	0.01028	40.42	213.4	0.8233
10,380	10	7	.0385	.116	0.008152	32.05	169.2	1.038
6,530	12	7	.0305	.0915	0.005129	20.16	106.5	1.650
4,107	14	7	.0242	.0726	0.003226	12.68	66.95	2.624
2,583	16	7	.0192	.0576	0.002029	7.975	42.11	4.172
1,624	18	7	.0152	.0456	0.001275	5.014	26.47	6.636
1,022	20	7	.0121	.0363	0.000827	3.155	16.66	10.54

* The resistance values in this table are trade maxima for soft or annealed copper wire and are higher than the average values for commercial cable. The following values for the conductivity and resistivity of copper at 20° centigrade were used:
 Conductivity in terms of International Annealed Copper Standard 98.16%
 Resistivity in pounds per mile-ohm 891.58
 The resistance of hard drawn copper is slightly greater than the values given, being about 2% to 3% greater for sizes from 4/0 to 20 AWG.

Machine screw head styles

Method of length measurement

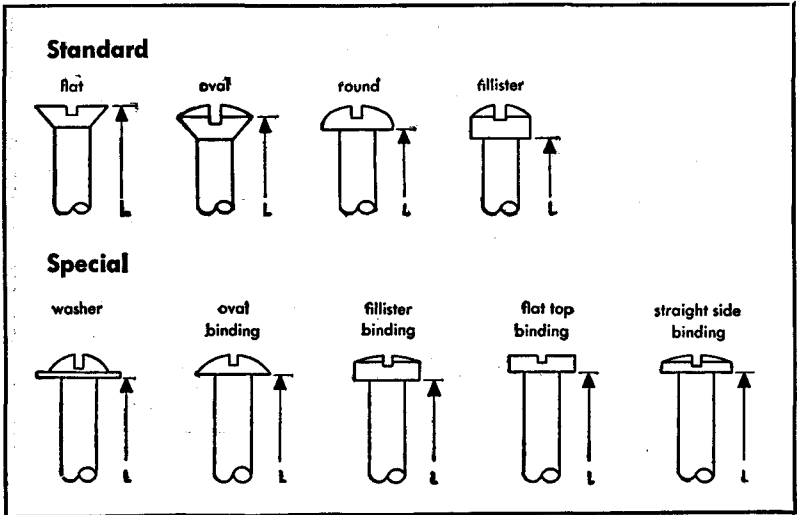

Standard machine screw data including hole sizes

size and no threads	screw			head					hex nut			washer			clearance drill*		tap drill†	
	od	depth of thread	minor diam	round		flat	flister		across flat	across corner	thick-ness	od	id	thick-ness	no	diam	no	diam
				min od	max height	max od	min od	max height										
2-56	.086	.0116	.0628	.146	.070	.172	.124	.055	.187	.217	.062	¼	.105	.020	42	.093	48	.076
3-48	.099	.0135	.0719	.169	.078	.199	.145	.063	.187	.217	.062	¼	.105	.020	37	.104	44	.086
4-40	.112	.0162	.0795	.193	.086	.225	.166	.072	.250	.289	.078	⅜	.120	.025	31	.120	40	.098
5-40	.125	.0162	.0925	.217	.095	.252	.187	.081	.250	.289	.078	⅜	.140	.032	29	.136	36	.106
6-32	.138	.0203	.0974	.240	.103	.279	.208	.089	.250 .312	.289 .361	.078 .109	⅝ ¾	.150	.026 .032	27	.144	33	.113
8-32	.164	.0203	.1234	.287	.119	.332	.250	.106	.250 .375	.289 .433	.078 .125	¾ 7/16	.170 .170	.032 .036	18	.169	28	.140
10-32	.190	.0203	.1494	.334	.136	.385	.292	.123	.312 .375	.361 .433	.109 .125	7/16 ½	.195 .195	.036 .040	9	.196	20	.161
12-24	.216	.0271	.1619	.382	.152	.438	.334	.141	.375 .437	.433 .505	.125 .125	½ 9/16	.228 .228	.060 .060	1	.228	15	.180
¼-20	.250	.0325	.185	.443	.174	.507	.389	.163	.437 .500	.505 .577	.125 .156 .125 .156	9/16 1 1/16	.260 .260	.040 .051		1 1/4	6	.204

All dimensions in inches.

* Clearance drill sizes are practical values for use of the engineer or technician doing his own shop work.

† Tap drill sizes are for use in hand tapping material such as brass or soft steel. For copper, aluminum, or Norway iron, the drill should be a size or two larger diameter than shown. For cast iron and bakelite, or for very thin material, the tap drill should be a size or two smaller diameter than shown.

material	dielectric constant			electrical properties*			dielectric strength kv/mm †	resistivity ohms-cm 25° C	physical properties	
	60~	10 ⁶ ~	10 ⁸ ~	60~	10 ⁶ ~	10 ⁸ ~			thermal expansion per ° C	softening point
Aniline Formaldehyde Resin	3.6	3.5	3.4	.003	.007	.004	16-25	> 10 ¹²	5.4 × 10 ⁻⁵	260° F
Casein					.052		16-28	Poor	5 × 10 ⁻⁵	200° F
Cellulose Acetate (plastic)	4.6	3.9	3.4	.007	.039	.039	10-14	10 ¹⁰	6-15 × 10 ⁻⁵	100-190° F
Cellulose Acetobutyrate	3.6	3.2	3.0	.004	.017	.019	10-16	10 ¹⁰	11-17 × 10 ⁻⁵	110-180° F
Ebonite	3.0	2.8	2.8	.008	.006	.004	18	2 × 10 ¹⁵	7 × 10 ⁻⁵	140° F
Ethyl Cellulose	4.0	3.4	3.2	.005	.028	.024	16-28	10 ¹⁵	3.4 × 10 ⁻⁴	120° F
Glass, Corning 707	4.0	4.0	4.0	.0006	.0008	.0012		1.5 × 10 ¹¹ at 250° C	31 × 10 ⁻⁷	1400° F
Glass, Corning 774	5.6	5.2	5.0	.0136	.0048	.008		1.4 × 10 ⁸ at 250° C	33 × 10 ⁻⁷	1500° F
Glass, Corning 790	3.9	3.9	3.9	.0006	.0006	.0006		5.2 × 10 ⁹ at 250° C	8 × 10 ⁻⁷	2600° F
Glass, Corning 7052	5.2	5.1	5.1	.008	.0024	.0036		1 × 10 ⁹ at 250° C	47 × 10 ⁻⁷	1300° F
Halowax	3.8	3.7	3.4	.002	.0014	.105		10 ¹⁴ -10 ¹⁴		190° F
Isolantite					.0018					
Melamine Formaldehyde Resin	7.5	4.5	4.5	.08	.08	.03	18		3.5 × 10 ⁻⁵	260° F
Methyl Methacrylate— a Lucite HM119	3.3	2.6	2.6	.066	.015	.007	16	10 ¹⁵	11-14 × 10 ⁻⁵	160° F
b Plexiglas	3.5	2.6	2.6	.064	.015	.007	16	10 ¹⁵	8 × 10 ⁻⁵	160° F
Mica	5.45	5.4	5.4	.005	.0003	.0003		5 × 10 ¹⁸		
Mycalax 364	7.1	7.0	7.0	.0064	.0021	.0022	14		8-9 × 10 ⁻⁶	660° F
Nylon FM-1	3.6	3.6	3.6	.018	.020	.018	12	10 ¹⁸	5.7 × 10 ⁻⁶	160° F
Paraffin Oil	2.2	2.2	2.2	.0001	.0001	.0004	15		7.1 × 10 ⁻⁴	liquid
Petroleum Wax (Paraffin Wax)	2.25	2.25	2.25	.0002	.0002	.0002	8-12	10 ¹⁸		M.P. 132° F
Phenol Formaldehyde Resins										
a general purpose	5.5	4.5	4.0	.018	.014	.014	14	10 ¹¹	3-4 × 10 ⁻⁵	275° F
b. mineral filled	4.6	4.4	4.3	.024	.006	.012	20			212° F
c. cast	8.0	8.0	8.0	.05	.05	.08	10		7.5-15 × 10 ⁻⁵	140° F
Phenol Furfural Resins	7.0	5.0	4.0	.20	.04	.05				
Polyethylene	2.25	2.25	2.25	.0003	.0003	.0003	40	> 10 ¹⁵	Varies	220° F
Polyisobutylene MW 100,000	2.20	2.22	2.22	.0003	.0003	.0004		10 ¹⁸		> 0° F
Polystyrene MW 80,000	2.55	2.53	2.52	.0002	.0002	.0003	20-30	10 ¹⁷	7 × 10 ⁻⁶	175° F
Polyvinyl Carbazole	2.95	2.95	2.95	.0017	.0005	.0006	31-40		4.5-5.5 × 10 ⁻⁶	300° F
Polyvinyl Chlor-Acetate	3.2	2.9	2.8	.009	.014	.009				180° F
Polyvinyl Chloride	3.2	2.9	2.9	.012	.016	.008				180° F
Polyvinylidene Chloride-Saran	4.5	3.0	2.8	.03	.046	.014	15	10 ¹⁵	1.58 × 10 ⁻⁴	175° F
Quartz (fused)	3.9	3.8	3.8	.0009	.0002	.0002	60		5.7 × 10 ⁻⁷	3000° F
Shellac	3.9	3.5	3.1	.006	.031	.030		10 ¹⁶		
Styraloy 22	2.4	2.4	2.4	.0010	.0012	.0043	30	10 ¹⁶	1.8 × 10 ⁻⁴	150° F
Styramic	2.9	2.75	2.73	.003	.0002	.0002			7 × 10 ⁻⁶	175° F
Styramic HT	2.64	2.64	2.62	.0002	.0002	.0002				250° F
Urea Formaldehyde Resins	6.6	5.6	5.0	.032	.028	.05	15	10 ¹⁸	2.6 × 10 ⁻⁵	260° F
Wood—African Mahogany (dry)	2.4	2.1	2.1	.01	.03	.04				
Balsa (dry)	1.4	1.4	1.3	.048	.012	.013				

* Values given are average for the materials listed.

† To convert Kilovolts per millimeter to volts per mil, multiply by 25.4

Plastics: trade names

trade name	composition	trade name	composition
Acryloid	Methacrylate Resin	Indur	Phenol Formaldehyde
Alvar	Polyvinyl Acetal	Kodapak	Cellulose Acetate
Amerith	Cellulose Nitrate	Kodapak II	Cellulose Acetobutyrate
Ameripol	Butadiene Copolymer	Koroseal	Modified Polyvinyl Chloride
Ameroid	Casein	Lectrofilm	Polyvinyl Carbazole (condenser material; mica substitute)
Bakelite	Phenol Formaldehyde	Loalim	Polystyrene
Bakelite	Urea Formaldehyde	Lucite	Methyl Methacrylate Resin
Bakelite	Cellulose Acetate	Lumarith	Cellulose Acetate
Bakelite	Polystyrene	Lumarith X	Cellulose Acetate
Beckamine	Urea Formaldehyde Resins	Lustron	Polystyrene
Beetle	Urea Formaldehyde	Luvican	Polyvinyl Carbazole
Butacite	Polyvinyl Butyral	Makalot	Phenol Formaldehyde
Butvar	Polyvinyl Butyral	Marbette	Phenol Formaldehyde (cast)
Cardolite	Phenol-aldehyde (cashew nut derivative)	Marbon B	Cyclized Rubber
Cerex	Styrene Copolymer	Marbon C	Rubber Hydrochloride
Catalin	Phenol Formaldehyde (cast)	Melmac	Melamine Formaldehyde
Cellophane	Regenerated Cellulose Film	Methocel	Methyl Cellulose
Celluloid	Cellulose Nitrate	Micabond	Glycerol Phthalic Anhydride, Mica
Cibanite	Aniline Formaldehyde	Micarta	Phenol Formaldehyde (lamination)
Crystalite	Acrylate and Methacrylate Resin	Monsanto	Cellulose Nitrate
Cumar	Cumarone-indene Resin	Monsanto	Polyvinyl Acetals
Dilectene 100	Aniline Formaldehyde Synthetic Resin	Monsanto	Cellulose Acetate
Dilecto	Urea Formaldehyde (phenol formaldehyde)	Monsanto	Phenol Formaldehyde
Dilecto UF	Urea Formaldehyde	Mycalex	Mica Bonded Glass
Distrene	Polystyrene	Neoprene	Chloroprene Synthetic Rubber
Durez	Phenol Formaldehyde	Nevidene	Cumarone-indene
Durite	Phenol Formaldehyde	Nitron	Cellulose Nitrate
Durite	Phenol Furfural	Nixonite	Cellulose Acetate
Erinofort	Cellulose Acetate	Nixonoid	Cellulose Nitrate
Erinoid	Casein	Nylon	Synthetic Polyamides and Super Polyamides
Ethocel	Ethyl Cellulose	Nypene	Polyterpene Resins
Ethocel PG	Ethyl Cellulose	Opalon	Phenol Formaldehyde
Ethofoil	Ethyl Cellulose	Panelyte	Phenol Formaldehyde (lamination)
Ethomelt	Ethyl Cellulose (hot pouring compound)	Panelyte	Phenol Formaldehyde
Ethomulsion	Ethyl Cellulose (lacquer emulsion)	Parlon	Chlorinated Rubber
Fibestos	Cellulose Acetate	Perspex	Methyl Methacrylic Ester
Flamenol	Vinyl Chloride (plasticized)	Plaskon	Urea Formaldehyde
Formica	Phenol Formaldehyde (lamination)	Plastacel	Cellulose Acetate
Formvar	Polyvinyl Formal	Plexiglas	Methyl Methacrylate
Galalith	Casein	Plexiglas	Acrylate and Methacrylate Resin
Gelva	Polyvinyl Acetate	Plaskon	Urea Formaldehyde
Gemstone	Phenol Formaldehyde	Plastacel	Cellulose Acetate
Geon	Polyvinyl Chloride	Pliofilm	Rubber Hydrochloride
Glyptal	Glycerol-phthalic Anhydride	Plioform	Rubber Derivative
Haveg	Phenol Formaldehyde Asbestos	Pliolite	Rubber Derivative
Hercose AP	Cellulose Acetate Propionate	Polyfibre	Polystyrene
Heresite	Phenol Formaldehyde	Polythene	Polyethylene

Plastics: trade names *continued*

trade name	composition	trade name	composition
Protectoid	Cellulose Acetate	Styron	Polystyrene
Prystal	Phenol Formaldehyde	Super Styrex	Polystyrene
Pyralin	Cellulose Nitrate	Synthane	Phenol Formaldehyde
PVA	Polyvinyl Alcohol	Tenite	Cellulose Acetate
Pyralin	Cellulose Nitrate	Tenite II	Cellulose Acetobutyrate
Resinox	Phenol Formaldehyde	Textolite	Various
Resoglaz	Polystyrene	Textolite 1421	Cross-linked Polystyrene
Rhodolene M	Polystyrene	Tornesif	Rubber Derivative
Rhodoid	Cellulose Acetate	Trolitul	Polystyrene
Ronilla L	Polystyrene	Vec	Polyvinylidene Chloride
Ronilla M	Polystyrene	Victron	Polystyrene
Saflex	Polyvinyl Butyral	Vinylite A	Polyvinyl Acetate
Saran	Polyvinylidene Chloride	Vinylite Q	Polyvinyl Chloride
Styraflex	Polystyrene	Vinylite V	Vinyl Chloride-Acetate Co-polymer
Styramic	Polystyrene-Chlorinated Diphenyl	Vinylite X	Polyvinyl Butyral
Styramic HT	Polydichlorstyrene		

Wind velocities and pressures

indicated velocities miles per hour* V_i	actual velocities miles per hour V_a	cylindrical surfaces pressure lbs per sq ft projected areas $P = 0.0025V_a^2$	flat surfaces pressure lbs per square foot $P = 0.0042V_a^2$
10	9.6	0.23	0.4
20	17.8	0.8	1.3
30	25.7	1.7	2.8
40	33.3	2.8	4.7
50	40.8	4.2	7.0
60	48.0	5.8	9.7
70	55.2	7.6	12.8
80	62.2	9.7	16.2
90	69.2	12.0	20.1
100	76.2	14.5	24.3
110	83.2	17.3	29.1
120	90.2	20.3	34.2
125	93.7	21.9	36.9
130	97.2	23.6	39.7
140	104.2	27.2	45.6
150	111.2	30.9	51.9
160	118.2	34.9	58.6
170	125.2	39.2	65.7
175	128.7	41.4	69.5
180	132.2	43.7	73.5
190	139.2	48.5	81.5
200	146.2	53.5	89.8

* As measured with a cup anemometer, these being the average maximum for a period of five minutes.

Temperature chart of heated metals

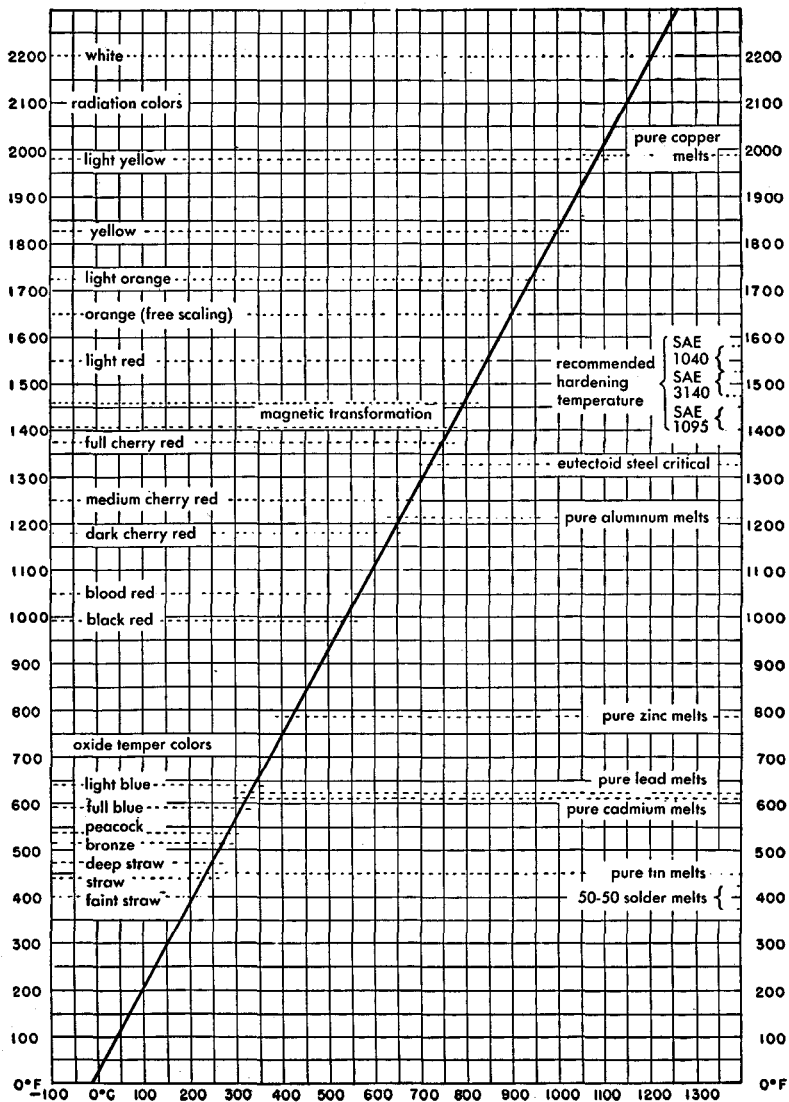

Physical constants of various metals and alloys*

material	relative resistance	temp coefficient of resistivity at 20°C	specific gravity	coefficient of thermal cond K watts/cm°C	melting point °C
Advance (55 Cu 45 Ni)	see	Constantan			
Aluminum	1.64	.004	2.7	2.03	660
Antimony	24.21	.0036	6.6	0.187	630
Arsenic	19.33	.0042	5.73	—	sublimes
Bismuth	69.8	.004	9.8	0.0755	270
Brass (66 Cu 34 Zn)	3.9	.002	8.47	1.2	920
Cadmium	4.4	.0038	8.64	0.92	321
Chromax (15 Cr 35 Ni balance Fe)	58.0	.00031	7.95	0.130	1380
Cobalt	5.6	.0033	8.71	—	1480
Constantan (55Cu45Ni)	28.45	±.0002	8.9	0.218	1210
Copper—annealed	1.00	.00393	8.89	3.88	1083
hard drawn	1.03	.00382	8.89	—	1083
Eureka (55 Cu 45 Ni)	see	Constantan			
Gas carbon	2900	—, .0005	—	—	3500
Gold	1.416	.0034	19.32	0.296	1063
Ideal (55 Cu 45 Ni)	see	Constantan			
Iron, pure	5.6	.0052–.0062	7.8	0.67	1535
Kovar A (29 Ni 17 Co 0.3 Mn balance Fe)	28.4	—	8.2	0.193	1450
Lead	12.78	.0042	11.37	0.344	327
Magnesium	2.67	.004	1.74	1.58	651
Manganin (84 Cu 12 Mn 4 Ni)	26	±.00002	8.5	0.63	910
Mercury	55.6	.00089	13.55	0.063	—38.87
Molybdenum, drawn	3.3	.0045	10.2	1.46	2630
Monel metal (67 Ni 30 Cu 1.4 Fe 1 Mn)	27.8	.002	8.8	0.25	1300–1350
Nichrome I (65 Ni 12 Cr 23 Fe)	65.0	.00017	8.25	0.132	1350
Nickel	5.05	.0047	8.85	0.6	1452
Nickel silver (64 Cu 18 Zn 18 Ni)	16.0	.00026	8.72	0.33	1110
Palladium	6.2	.0038	12.16	0.7	1557
Phosphor-bronze (4 Sn 0.5 P balance Cu)	5.45	—	8.9	0.82	1050
Platinum	6.16	.0038	21.4	0.695	1771
Silver	9.5	.004	10.5	4.19	960.5
Steel, manganese (13 Mn 1 C 86 Fe)	41.1	—	7.81	0.113	1510
Steel, SAE 1045 (0.4–0.5 C balance Fe)	7.6–12.7	—	7.8	0.59	1480
Steel, 18–8 stainless (0.1 C 18 Cr 8 Ni balance Fe)	52.8	—	7.9	0.163	1410
Tantalum	9.0	.0033	16.6	0.545	2850
Tin	6.7	.0042	7.3	0.64	231.9
Tophet A (80 Ni 20 Cr)	62.5	.02–.07	8.4	0.136	1400
Tungsten	3.25	.0045	19.2	1.6	3370
Zinc	3.4	.0037	7.14	1.12	419
Zirconium	2.38	.0044	6.4	—	1860

* See following page.

Physical constants of various metals and alloys *continued***Definitions of physical constants in preceding table**

The preceding table of relative resistances gives the ratio of the resistance of any material to the resistance of a piece of annealed copper of identical physical dimensions and temperature.

1. The resistance of any substance of uniform cross-section is proportional to the length and inversely proportional to the cross-sectioned area.

$$R = \frac{\rho L}{A}, \text{ where } \rho = \text{resistivity, the proportionality constant,}$$

L = length, A = cross-sectional area, R = resistance in ohms.

If L and A are measured in centimeters, ρ is in ohm-centimeters.

If L is measured in feet, and A in circular mils, ρ is in ohm-circular mils per foot.

Relative resistance = ρ divided by the resistivity of copper (1.7241×10^{-6} ohm-cm).

2. The temperature coefficient of resistivity gives the ratio of the change in resistivity due to a change in temperature of 1°C relative to the resistivity at 20°C . The dimensions of this quantity are ohms per $^\circ\text{C}$ per ohm or $1/^\circ\text{C}$.

The resistance at any temperature is:

$$R = R_0 (1 + \alpha T), \text{ } R_0 = \text{resistance at } 0^\circ \text{ in ohms, } T = \text{temperature in degrees centigrade, } \alpha = \text{temperature coefficient of resistivity } 1/^\circ\text{C.}$$

3. The specific gravity of a substance is defined as the ratio of the weight of a given volume of the substance to the weight of an equal volume of water.

In the cgs system, the specific gravity of a substance is exactly equal to the weight in grams of one cubic centimeter of the substance.

4. Coefficient of thermal conductivity is defined as the time rate of heat transfer through unit thickness, across unit area, for a unit difference in temperature. Expressing rate of heat transfer in watts, the coefficient of thermal conductivity

$$K = \frac{WL}{A\Delta T}$$

W = watts, L = thickness in cm, A = area in sq cm, ΔT = temperature in $^\circ\text{C}$.

5. Specific heat is defined as the number of calories required to heat one gram of a substance one degree Centigrade.

$$H = ms \Delta T \text{ or change in heat} \quad m = \text{mass in grams}$$

$$\Delta T = \text{temperature change } ^\circ\text{C} \quad s = \text{specific heat in cal/gm}/^\circ\text{C}$$

Thermocouples and their characteristics

type	copper/constantan		iron/constantan		chromel/constantan		chromel/alumel		platinum/platinum rhodium (10)		platinum/platinum rhodium (13)		carbon/silicon carbide		
Composition, percent	100Cu 99.9Cu	54Cu 46Ni 55Cu 45Ni 60Cu 40Ni	100Fe 55Cu 44Ni .5Mn + Fe, Si		90Ni 10Cr 55Cu 45Ni		90Ni 10Cr 89.6Ni 8.9Cr 89Ni 10Cr 39Ni 9.8Cr	95Ni 2Al 2Mn 1Si 97Ni 3Al + Si 94Ni 2Al 1Si 2.5Mn 0.5Fe 1Fe 0.2Mn	Pt	90Pt 10Rh	Pt	87Pt 13Rh	C	SiC	
Range of application, °C	-250 to +600		-200 to +1050		0 to 1100		0 to 1100		0 to 1550					to 2000	
Resistivity, micro-ohm-C.M.	1.75	49	10	49	70	49	70	29.4	10	21					
Temperature coefficient of resistivity, °C	.0039	.00001	.005	.00001	.00035	.0002	.00035	.000125	.0030	.0018					
Melting temperature, °C	1085	1190	1535	1190	1400	1190	1400	1430	1755	1700			3000	2700	
EMF in mv reference junction at 0° C	100° C 200 300	4.24mv 9.06 14.42	100° C 200 400 600 800 1000	5.28mv 10.78 21.82 33.16 45.48 58.16	100° C 200 400 600	6.3mv 13.3 28.5 44.3	100° C 200 400 600 800 1000 1200 1400	4.1 mv 8.13 16.39 24.90 33.31 41.31 48.85 55.81	100° C 200 400 600 800 1000 1200 1400 1600	0.643mv 1.436 3.251 5.222 7.330 9.569 11.924 14.312 16.674	100° C 200 400 600 800 1000 1200 1400 1600	0.646mv 1.464 3.398 5.561 7.927 10.470 13.181 15.940 18.680	1210° C 1300 1360 1450	353.6mv 385.2 403.2 424.9	
Influence of temperature and gas atmosphere	Subject to oxidation and alteration above 400° C due Cu, above 600° due constantan wire. Ni-plating of Cu tube gives protection, in acid-containing gas. Contamination of Cu affects calibration greatly. Resistance to oxid. atm. good. Resistance to reducing atm. good. Requires protection from acid fumes.		Oxidizing and reducing atmosphere have little effect on accuracy. Best used in dry atmosphere. Resistance to oxidation good to 400° C. Resistance to reducing atmosphere good. Protect from oxygen, moisture, sulphur.		Chromel attacked by sulphurous atmosphere. Resistance to oxidation good. Resistance to reducing atmosphere poor.		Resistance to oxidizing atmosphere very good. Resistance to reducing atmosphere poor. Affected by sulphur, reducing or sulphurous gas, SO ₂ and H ₂ S.		Resistance to oxidizing atmosphere very good. Resistance to reducing atmosphere poor. Susceptible to chemical alteration by As, Si, P vapor in reducing gas (CO ₂ , H ₂ , H ₂ S, SO ₂). Pt corrodes easily above 1000°. Used in gas-tight protecting tube.		Resistance to oxidizing atmosphere very good. Resistance to reducing atmosphere poor. Susceptible to chemical alteration by As, Si, P vapor in reducing gas (CO ₂ , H ₂ , H ₂ S, SO ₂). Pt corrodes easily above 1000°. Used in gas-tight protecting tube.		Used as tube element. Carbon sheath chemically inert.		
Particular applications	Low temperature, industrial. Internal combustion engine. Used as a tube element for measurements in steam line.		Low temperature, industrial. Internal combustion engine, boiler flues, tube stills. Used in reducing or neutral atmosphere.				Used in oxidizing atmosphere. Industrial. Ceramic kilns, tube stills, electric furnaces.		International Standard 630 to 1065° C.		Similar to Pt/PtRh(10) but has higher emf.		Steel furnace and ladle temperatures. Laboratory measurements.		

Thermocouples and their characteristics *continued*

Characteristics of typical thermocouples

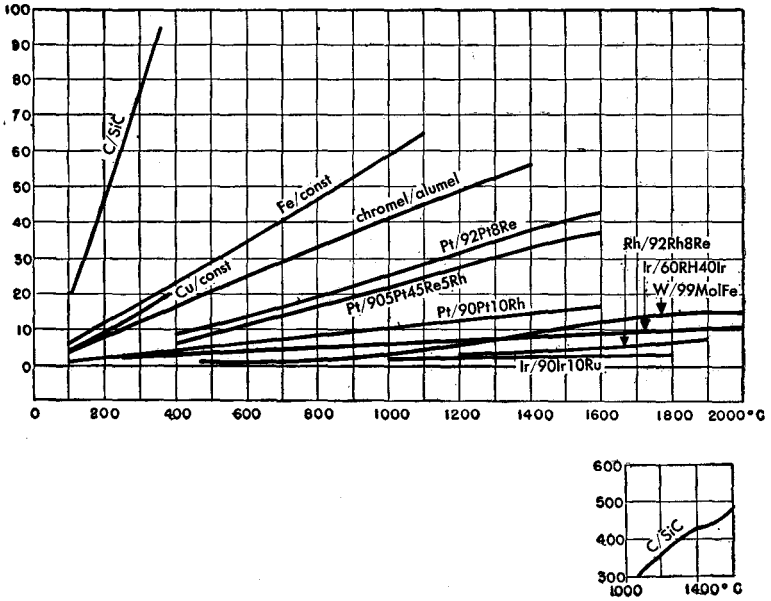

Compiled from "Temperature Measurement and Control" by R. L. Weber, pages 68-71.

Melting points of solder

pure alloys		melting points	
percent tin	percent lead	degrees centigrade	degrees fahrenheit
100		232	450
90	10	213	415
80	20	196	385
70	30	186	367
65	35	181	358
60	40	188	370
50	50	212	414
40	60	238	460
30	70	257	496
20	80	290	554
10	90	302	576
	100	327	620

Spark-gap break down voltages

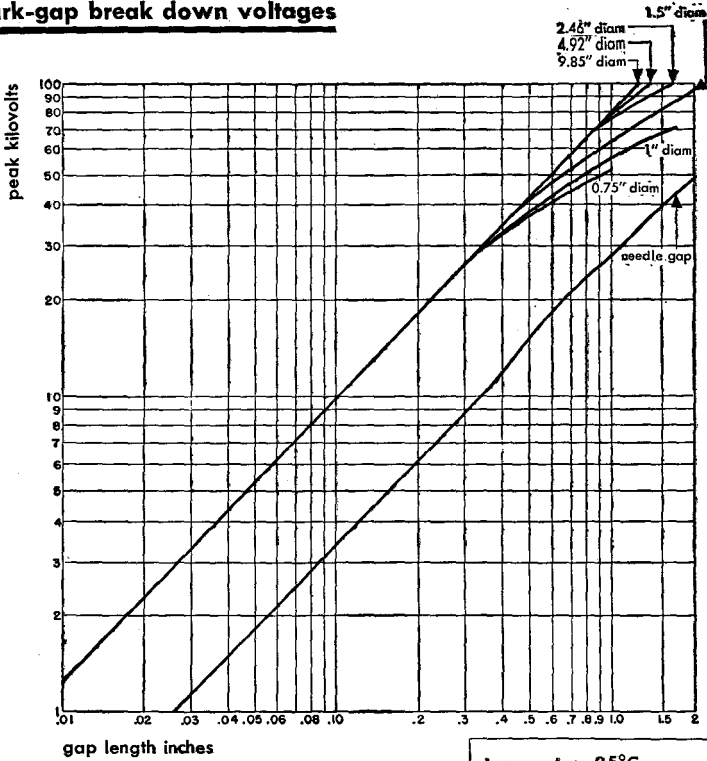

Data for a voltage which is continuous or at a frequency low enough to permit complete deionization between cycles, between needle points or clean, smooth spherical surfaces in dust-free dry air. The following multiplying factors apply for atmospheric conditions other than those stated above:

pressure		temperature ° C					
" Hg	mm Hg	-40	-20	0	20	40	60
5	127	0.26	0.24	0.23	0.21	0.20	0.19
10	254	0.47	0.44	0.42	0.39	0.37	0.34
15	381	0.68	0.64	0.60	0.56	0.53	0.50
20	508	0.87	0.82	0.77	0.72	0.68	0.64
25	635	1.07	0.99	0.93	0.87	0.82	0.77
30	762	1.25	1.17	1.10	1.03	0.97	0.91
35	889	1.43	1.34	1.26	1.19	1.12	1.05
40	1016	1.61	1.51	1.42	1.33	1.25	1.17
45	1143	1.79	1.68	1.58	1.49	1.40	1.31
50	1270	1.96	1.84	1.73	1.63	1.53	1.44
55	1397	2.13	2.01	1.89	1.78	1.67	1.57
60	1524	2.30	2.17	2.04	1.92	1.80	1.69

Head of water in feet and approximate discharge rate

Table I

head of fall in feet	discharge in US gallons per minute											
	½"	¾"	1"	1¼"	1½"	2"	2½"	3"	3½"	4"	5"	6"
1	.19	.54	1.11	1.96	3.09	6.34	11.07	17.41	25.58	35.79	62.57	98.72
2	.28	.77	1.59	2.76	4.36	8.96	15.61	24.62	36.15	50.56	88.39	139.31
4	.40	1.09	2.25	3.92	6.17	12.73	22.10	34.95	61.28	71.58	124.90	196.54
6	.48	1.33	2.75	4.78	7.55	15.49	27.02	42.63	62.69	87.67	182.52	241.39
9	.59	1.63	3.36	5.86	9.26	19.09	33.27	52.36	76.98	107.48	187.35	295.43
12	.68	1.89	3.90	6.77	10.69	21.98	38.43	60.53	88.87	123.70	216.17	342.27
16	.79	2.17	4.48	7.82	12.37	25.34	44.31	69.77	102.56	142.91	249.80	395.11
20	.89	2.44	5.02	8.74	13.61	28.34	49.48	77.94	114.57	159.73	279.82	440.74
25	.98	2.73	5.61	9.78	15.00	31.70	55.36	87.19	127.30	178.94	312.24	493.59
30	1.08	2.98	6.14	10.71	16.93	34.59	60.65	95.47	139.31	195.75	342.27	540.42
40	1.25	3.46	7.10	12.37	19.58	40.23	70.01	110.49	162.13	225.78	395.11	624.49
50	1.39	3.86	7.94	13.81	21.86	44.92	78.30	122.50	180.14	252.20	441.95	697.75
75	1.71	4.72	9.73	16.93	26.78	54.88	95.96	150.12	220.97	309.84	541.62	855.07
100	1.98	5.46	11.23	19.58	30.81	63.41	110.72	174.14	255.80	357.88	625.69	987.17
150	2.44	6.71	13.81	23.90	37.83	77.94	139.19	213.77	314.65	439.54	746.00	1,214.15
200	2.80	7.71	15.85	27.62	43.59	89.59	156.12	246.19	361.48	505.60	883.89	1,394.29
250	3.13	8.65	17.77	30.81	48.88	100.52	175.34	276.22	404.72	565.64	989.57	1,564.82
500	4.43	12.25	25.10	43.71	69.05	141.71	247.39	390.31	571.65	801.03	1,397.89	2,209.73

Discharge in gallons per minute through 1000 ft. pipe line of ½" to 6" bore with average number of bends and fittings. For other pipe lengths see Table II.

Table II

Length in feet	50	100	150	200	300	400	500	750	1,000	1,250	1,500
Factor	4.47	3.16	2.58	2.237	1.827	1.580	1.414	1.154	1.0	0.895	0.817
Length in feet	1,750	2,000	2,500	3,000	4,000	5,000	7,500	10,000	5 mi.	10 mi.	50 mi.
Factor	0.756	0.707	0.633	0.577	0.500	0.447	0.365	0.316	0.195	0.138	0.0616

Multiplication factor to be applied to Table I for pipe lengths other than 1000 ft.

Example: Required—approximate discharge of a line of piping 4" bore, 5000 feet long, under 30 foot head.

Approximate discharge for the 1000 foot line from Table I = 195.75 gallons per minute. Factor from Table II = 0.447

∴ Approximate discharge = 195.75 × 0.447 = 87.5

Materials and finishes for tropical and marine use

Ordinary finishing of equipment fails in meeting satisfactorily conditions encountered in tropical and marine use. Under these conditions corrosive influences are greatly aggravated by prevailing higher relative humidities, and temperature cycling causes alternate condensation on, and evaporation of moisture from, finished surfaces. Useful equipment life under adverse atmospheric influences depends largely on proper choice of base materials and finishes applied. Especially important in tropical and marine applications is avoidance of electrical contact between dissimilar metals.

Dissimilar metals, widely separated in the galvanic series, should not be bolted, riveted, etc., without separation by insulating material at the faying surfaces. The only exception occurs when both surfaces have been coated with the same protective metal, e.g., electroplating, hot dipping, galvanizing, etc.

In addition to choice of deterioration-resistant materials, consideration must be given to weight, need for a conductive surface, availability of ovens, appearance, etc.

A—order of preference:

Base materials

- | | |
|--------------------|------------------------------|
| 1. Brass | 6. Aluminum, anodized |
| 2. Nickel silver | 7. Steel, zinc phosphated |
| 3. Phosphor—bronze | 8. Steel, cadmium phosphated |
| 4. Monel | 9. Steel, phosphated |
| 5. Stainless steel | |

Finishes

1. Baked paint
2. Force dried paint
3. Air dried paint (pigmentless paint, e.g., varnish)

B—order of preference: (if A is impracticable)

Base materials

1. Copper
2. Steel

Finishes

- | | |
|---------------------------|------------------------|
| 1. Copper—nickel—chromium | 5. Cadmium, lacquered |
| 2. Copper—nickel—oxide | 6. Zinc, phosphated |
| 3. Copper—nickel | 7. Cadmium, phosphated |
| 4. Zinc, lacquered | |

Materials and finishes for tropical and marine use *continued*

Aluminum should always be anodized. Aluminum, steel, zinc, and cadmium should never be used bare.

Electrical contact surfaces should be given above finish B-1 or 3, and, in addition, they should be silver plated.

Variable capacitor plates should be silver plated.

All electrical circuit elements and uncoated metallic surfaces (except electrical contact surfaces) inside of cabinets should receive a coat of fungicidal moisture repellent varnish or lacquer.

Wood parts should receive:

1. Dip coat of fungicidal water repellent sealer.
2. One coat of refinishing primer.
3. Suitable topcoat.

Torque and horsepower

Torque varies directly with power and inversely with rotating speed of the shaft, or

$$T = \frac{KP}{N}$$

where T = torque in inch-pounds, P = hp, N = rpm, K (constant) = 63,000.

Example 1: For a two-horsepower motor rotating at 1800 rpm,

$$T = \frac{63,000 \times 2}{1800} = 70 \text{ inch-pounds.}$$

If the shaft is 1 inch in diameter, the force at its periphery

$$F = \frac{T}{\text{Radius}} = \frac{70 \text{ inch-pounds}}{0.5} = 140 \text{ pounds}$$

Example 2: If 150 inch-pounds torque are required at 1200 rpm,

$$150 = \frac{63,000 \text{ hp}}{1200} \quad \text{hp} = \frac{150 \times 1200}{63,000} = 2.86 \text{ pounds}$$

■ Audio and radio design

Resistors and capacitors

Color code color	significant figure	decimal multiplier	tolerance %		voltage rating RMA 1938 std†	characteristic AWS and JAN mica capacitors
			RMA 1938 std	AWS and JAN*		
Black	0	1	—	±20% M	—	A
Brown	1	10	1	±2% G	100	B
Red	2	100	2		200	C
Orange	3	1,000	3		300	D
Yellow	4	10,000	4		400	E
Green	5	100,000	5		500	F
Blue	6	1,000,000	6		600	G
Violet	7	10,000,000	7		700	—
Gray	8	100,000,000	8		800	—
White	9	1,000,000,000	9		900	—
Gold	—	0.1	±5	±5% J	1,000	—
Silver	—	0.01	±10	±10% K	2,000	—
No color	—	—	±20		500	—

* Letter used to indicate tolerance in type designations.

† Applies to capacitors only.

Resistors, fixed composition

RMA Standard, American War Standard, and Joint Army-Navy Specifications for color coding of fixed composition resistors are identical in all respects.

The exterior body color of insulated axial-lead composition resistors is usually tan, but other colors, except black, are permitted. Non-insulated, axial-lead composition resistors have a black body color. Radial-lead composition resistors may have a body color representing the first significant figure of the resistance value.

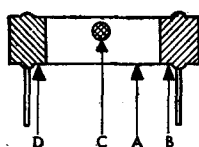
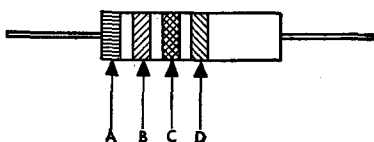

axial leads	color	radial leads
Band A	indicates first significant figure of resistance value in ohms.	Body A
Band B	indicates second significant figure.	End B
Band C	indicates decimal multiplier.	Band C or dot
Band D	if any, indicates tolerance in percent about nominal resistance value. If no color appears in this position, tolerance is 20%.	Band D

Note: Low-power insulated wire-wound resistors have axial leads and are color coded similar to the left-hand figure above except that band A is double width.

Standard color coding for resistors

preferred values of resistance (ohms)			old standard resistance values (ohms)	resistance designation			preferred values of resistance (ohms)			old standard resistance values (ohms)	resistance designation		
±20% D = no col	±10% D = silver	±5% D = gold		A	B	C	±20% D = no col	±10% D = silver	±5% D = gold		A	B	C
		51	50	Green	Black	Black	1,000	1,000	1,000	1,000	Brown	Black	Red
		56		Green	Brown	Black			1,100		Brown	Brown	Red
		62	75	Green	Blue	Black			1,200	1,200	Brown	Red	Red
	68	68		Blue	Red	Black			1,300		Brown	Orange	Red
		75	100	Blue	Gray	Black	1,500	1,500	1,500	1,500	Brown	Green	Red
		82		Violet	Green	Black			1,600		Brown	Blue	Red
		82	150	Gray	Red	Black			1,800	2,000	Brown	Gray	Red
		91		White	Brown	Black			2,000		Red	Black	Red
	100	100	200	Brown	Black	Brown	2,200	2,200	2,200	2,500	Red	Red	Red
		110		Brown	Brown	Brown			2,400		Red	Yellow	Red
		120	300	Brown	Red	Brown			2,700	3,000	Red	Green	Red
		130		Brown	Orange	Brown			2,700		Red	Violet	Red
	150	150	350	Brown	Green	Brown			3,000	3,500	Orange	Black	Red
		160		Brown	Blue	Brown	3,300	3,300	3,300		Orange	Orange	Red
		180	400	Brown	Gray	Brown			3,600	4,000	Orange	Green	Red
		200		Red	Black	Brown			3,900		Orange	Blue	Red
	220	220	450	Red	Red	Brown			3,900	5,000	Orange	White	Red
		240		Red	Yellow	Brown			4,300		Orange	Black	Red
		270	500	Red	Green	Brown			4,300	5,000	Yellow	Orange	Red
		300		Orange	Violet	Brown	4,700	4,700	4,700		Yellow	Violet	Red
	330	330	550	Orange	Black	Brown			5,100	6,000	Green	Black	Red
		330		Orange	Orange	Brown			5,600		Green	Brown	Red
		360	600	Orange	Green	Brown			5,600	7,500	Green	Blue	Red
		390		Orange	Blue	Brown			6,200		Green	Red	Red
		390	700	Orange	White	Brown	6,800	6,800	6,800	8,200	Blue	Gray	Red
		430		Yellow	Black	Brown			7,500		Blue	Green	Red
		470	800	Yellow	Orange	Brown			8,200	10,000	Violet	Red	Red
		470		Yellow	Green	Brown			9,100		Gray	Brown	Red
		510	900	Yellow	Violet	Brown	10,000	10,000	10,000	12,000	White	Black	Orange
		560		Green	Black	Brown			11,000		Brown	Brown	Orange
		560	1,000	Green	Brown	Brown			12,000	15,000	Brown	Red	Orange
		620		Green	Blue	Brown			13,000		Brown	Orange	Orange
		680	1,200	Blue	Black	Brown	15,000	15,000	15,000	20,000	Brown	Green	Orange
		680		Blue	Red	Brown			16,000		Brown	Blue	Orange
		750	1,500	Blue	Gray	Brown			18,000	22,000	Brown	Gray	Orange
		820		Violet	Green	Brown			20,000		Brown	Black	Orange
		820	2,000	Violet	Red	Brown	22,000	22,000	22,000	24,000	Red	Red	Orange
		910		Gray	Red	Brown			24,000		Red	Yellow	Orange

continued Standard color coding for resistors

preferred values of resistance (ohms)			old standard resistance values (ohms)	resistance designation			preferred values of resistance (ohms)			old standard resistance values (ohms)	resistance designation		
±20% D = no col	±10% D = silver	±5% D = gold		A	B	C	±20% D = no col	±10% D = silver	±5% D = gold		A	B	C
			25,000	Red	Green	Orange							
	27,000	27,000		Red	Violet	Orange		510,000		Green	Brown	Yellow	
		30,000	30,000	Black	Black	Orange		560,000		Green	Blue	Yellow	
33,000	33,000	33,000		Orange	Orange	Orange			600,000	Blue	Black	Yellow	
		36,000		Orange	Orange	Orange		620,000		Blue	Red	Yellow	
	39,000	39,000		Orange	Blue	Orange	680,000	680,000	680,000	Blue	Gray	Yellow	
			40,000	Orange	White	Orange			750,000	Violet	Green	Yellow	
		43,000		Yellow	Black	Orange		820,000		Gray	Red	Yellow	
47,000	47,000	47,000		Yellow	Orange	Orange	1.0 Meg	1.0 Meg	1.0 Meg	White	Brown	Yellow	
			50,000	Green	Violet	Orange			1.0 Meg	Brown	Black	Green	
		51,000		Green	Black	Orange		1.1 Meg		Brown	Brown	Green	
	56,000	56,000		Green	Brown	Orange		1.2 Meg	1.2 Meg	Brown	Red	Green	
			60,000	Green	Blue	Orange			1.5 Meg	Brown	Orange	Green	
		62,000		Blue	Black	Orange	1.5 Meg	1.5 Meg		Brown	Green	Green	
	68,000	68,000		Blue	Red	Orange			1.5 Meg	Brown	Blue	Green	
		75,000		Blue	Gray	Orange		1.8 Meg	1.8 Meg	Brown	Gray	Green	
	82,000	82,000		Violet	Green	Orange			2.0 Meg	Red	Black	Green	
		82,000	75,000	Gray	Red	Orange	2.2 Meg	2.2 Meg		Red	Red	Green	
		91,000		White	Brown	Orange				Red	Yellow	Green	
100,000	100,000	100,000	100,000	Brown	Black	Yellow		2.7 Meg	2.7 Meg	Red	Violet	Green	
		110,000		Brown	Brown	Yellow			3.0 Meg	Orange	Black	Green	
	120,000	120,000	120,000	Brown	Red	Yellow	3.3 Meg	3.3 Meg		Orange	Orange	Green	
		130,000		Brown	Orange	Yellow				Orange	Blue	Green	
150,000	150,000	150,000	150,000	Brown	Green	Yellow		3.9 Meg	3.9 Meg	Orange	White	Green	
		160,000		Brown	Blue	Yellow			4.0 Meg	Yellow	Black	Green	
	180,000	180,000		Brown	Gray	Yellow		4.3 Meg		Yellow	Orange	Green	
		200,000	200,000	Red	Black	Yellow	4.7 Meg	4.7 Meg		Yellow	Violet	Green	
220,000	220,000	220,000		Red	Red	Yellow			5.0 Meg	Green	Black	Green	
		240,000		Red	Yellow	Yellow		5.1 Meg		Green	Brown	Green	
			250,000	Red	Green	Yellow		5.6 Meg	5.6 Meg	Green	Blue	Green	
	270,000	270,000		Red	Violet	Yellow			6.0 Meg	Blue	Black	Green	
		300,000	300,000	Orange	Black	Yellow		6.2 Meg		Blue	Red	Green	
330,000	330,000	330,000		Orange	Orange	Yellow	6.8 Meg	6.8 Meg		Blue	Gray	Green	
		360,000		Orange	Blue	Yellow			7.0 Meg	Violet	Black	Green	
	390,000	390,000		Orange	White	Yellow		7.5 Meg		Violet	Green	Green	
			400,000	Yellow	Black	Yellow			8.0 Meg	Gray	Black	Green	
		430,000		Yellow	Orange	Yellow		8.2 Meg	8.2 Meg	Gray	Red	Green	
470,000	470,000	470,000	500,000	Yellow	Violet	Yellow			9.0 Meg	White	Black	Green	
				Green	Black	Yellow	10 Meg	10 Meg		White	Brown	Green	
									10 Meg	Brown	Black	Blue	

Capacitors, fixed mica dielectric

Fixed mica-dielectric capacitors of the American War Standards and Joint Army-Navy Specification are designated differently from the 1938 RMA Standard. AWS and JAN mica capacitors have a characteristic defined in Table I.

Table I

characteristic	Q	temperature coefficient parts/million/°C	maximum capacitance drift	verification of characteristics by production test
A	*	Not specified	Not specified	Not required
B	†	Not specified	Not specified	Not required
C	†	-200 to +200	0.5 percent	Not required
D	†	-100 to +100	0.2 percent	Not required
E	†	0 to +100	0.05 percent	Not required
F	†	0 to +50	0.025 percent	Required
G	†	0 to -50	0.025 percent	Required

* Q must be greater than 1/3 of minimum allowable Q for other characteristics (JAN).
 † Minimum acceptable Q at 1 MC is defined by a curve; value varies with capacitance.

Type designations of AWS or JAN fixed mica-dielectric capacitors are a comprehensive numbering system used to identify the component. The capacitor type designation is given in the following form:



Component designation: Fixed mica-dielectric capacitors are identified by the symbol CM.

Case designation: The case designation is a 2-digit symbol which identifies a particular case size and shape.

Characteristic: The characteristic is indicated by a single letter in accordance with Table I.

Capacitance value: The nominal capacitance value in micromicrofarads is indicated by a 3-digit number. The first two digits are the first two digits of the capacitance value in micromicrofarads. The final digit specifies the number of zeros which follow the first two digits. If more than two significant figures are required, additional digits may be used, the last digit always indicating the number of zeros.

Capacitance tolerance: The symmetrical capacitance tolerance in percent is designated by a letter as shown on page 52.

Capacitors, fixed mica dielectric *continued*

AWS and JAN fixed capacitors

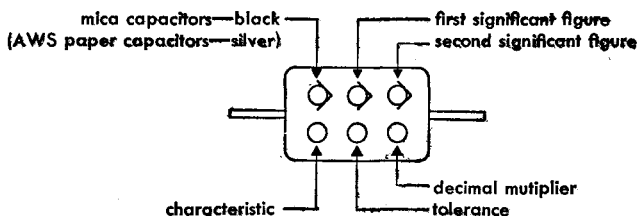

RMA fixed capacitors

The 1938 RMA Standard covers a simple 3-dot color code showing directly only the capacitance, and a more comprehensive 6-dot color code showing 3 significant figures and tolerance of the capacitance value, and a voltage rating. Capacitance values are expressed in micromicrofarads up to 10,000 micromicrofarads.

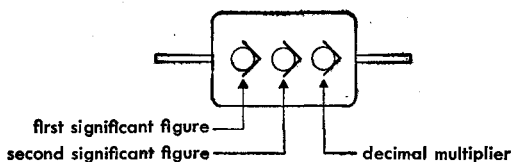

RMA 3-dot 500-volt, $\pm 20\%$ tolerance only

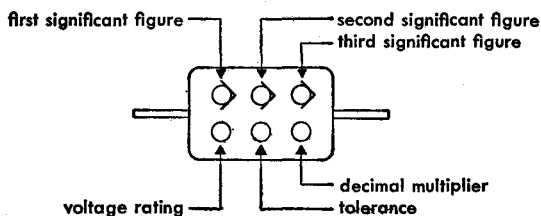

RMA 6-dot

Examples

type	top row			bottom row			description
	left	center	right	left	center	tolerance multiplier	
RMA (3 dot)	red	green	brown	none	none	none	250 $\mu\mu\text{f} \pm 20\%$, 500 volts
RMA	brown	black	black	blue	green	brown	1000 $\mu\mu\text{f} \pm 5\%$, 600 volts
RMA	brown	red	green	gold	red	brown	1250 $\mu\mu\text{f} \pm 2\%$, 1000 volts
CM30B681J	black	blue	gray	brown	gold	brown	680 $\mu\mu\text{f} \pm 5\%$, characteristic B
CM35E332G	black	orange	orange	yellow	red	red	3300 $\mu\mu\text{f} \pm 2\%$, characteristic E

Capacitors, fixed ceramic

Tubular ceramic dielectric capacitors are used for temperature compensation of tuned circuits and have many other applications as well. If the capacitance, tolerance, and temperature coefficient are not printed on the capacitor body, the following color code will be used. The change in capacitance per unit capacitance per degree centigrade is the temperature coefficient, usually stated in parts per million per centigrade (ppm/°C).

color	significant figure	multiplier	capacitance tolerance		temperature coefficient parts/million/° C
			in % $c > 10 \mu\mu\text{f}$	in $\mu\mu\text{f}$ $c < 10 \mu\mu\text{f}$	
black	0	1	± 20	2.0	0
brown	1	10	± 1		-30
red	2	100	± 2		-80
orange	3	1,000			-150
yellow	4	—			-220
green	5	—	± 5	0.5	-330
blue	6	—			-470
violet	7	—			-750
gray	8	0.01		0.25	+30
white	9	0.1	± 10	1.0	-330 ± 500

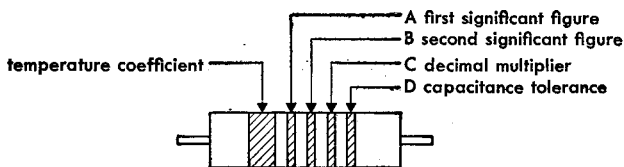

Examples

wide band	narrow bands or dots				description
	A	B	C	D	
black	black	red	black	black	$2.0 \mu\mu\text{f} \pm 2 \mu\mu\text{f}$, zero temp coeff
blue	red	red	black	green	$22 \mu\mu\text{f} \pm 5\%$, $-470 \text{ ppm}/^\circ\text{C}$ temp coeff
violet	gray	red	brown	silver	$820 \mu\mu\text{f} \pm 10\%$, $-750 \text{ ppm}/^\circ\text{C}$ temp coeff

Inductance of single-layer solenoids

The approximate value of the *low-frequency* inductance of a single-layer solenoid is:

$$L = Fn^2d \text{ microhenries*}$$

where F = form factor, a function of the ratio d/l . The value of F may be read from the accompanying chart, Fig. 1:

n = number of turns, d = diameter of coil (inches), between centers of conductors, l = length of coil (inches) = n times the distance between centers of adjacent turns.

The formula is based on the assumption of a uniform current sheet, but the correction due to the use of spaced round wires is usually negligible for practical purposes. For higher frequencies skin effect alters the inductance slightly. This effect is not readily calculated, but is often negligibly small. However, it must be borne in mind that the formula gives approximately the *true* value of inductance. In contrast, the *apparent* value is affected by the shunting effect of the distributed capacitance of the coil.

Example: Required a coil of 100 microhenries inductance, wound on a form 2 inches diameter by 2 inches winding length. Then $d/l = 1.00$, and $F = 0.0173$ on the chart.

$$n = \sqrt{\frac{L}{Fd}} = \sqrt{\frac{100}{0.0173 \times 2}} = 54 \text{ turns}$$

Reference to Magnet Wire Data, page 60, will assist in choosing a desirable size of wire, allowing for a suitable spacing between turns according to the application of the coil. A slight correction may then be made for the increased diameter (diameter of form plus two times radius of wire), if this small correction seems justified.

In the use of various charts, tables, and *calculators* for designing inductors, the following relationships are useful in extending the range of the devices. They apply to coils of any type or design.

1. If all dimensions are held constant, inductance is proportional to n^2 .
2. If the proportions of the coil remain unchanged, then for a given number of turns the inductance is proportional to the dimensions of the coil. A coil with all dimensions m times those of a given coil (having the same number of turns) has m times the inductance of the given coil. That is, inductance has the dimensions of *length*.

* Formulas and chart (Fig. 1) derived from equations and tables in Bureau of Standards Circular No. 74.

Inductance of single-layer solenoids *continued*

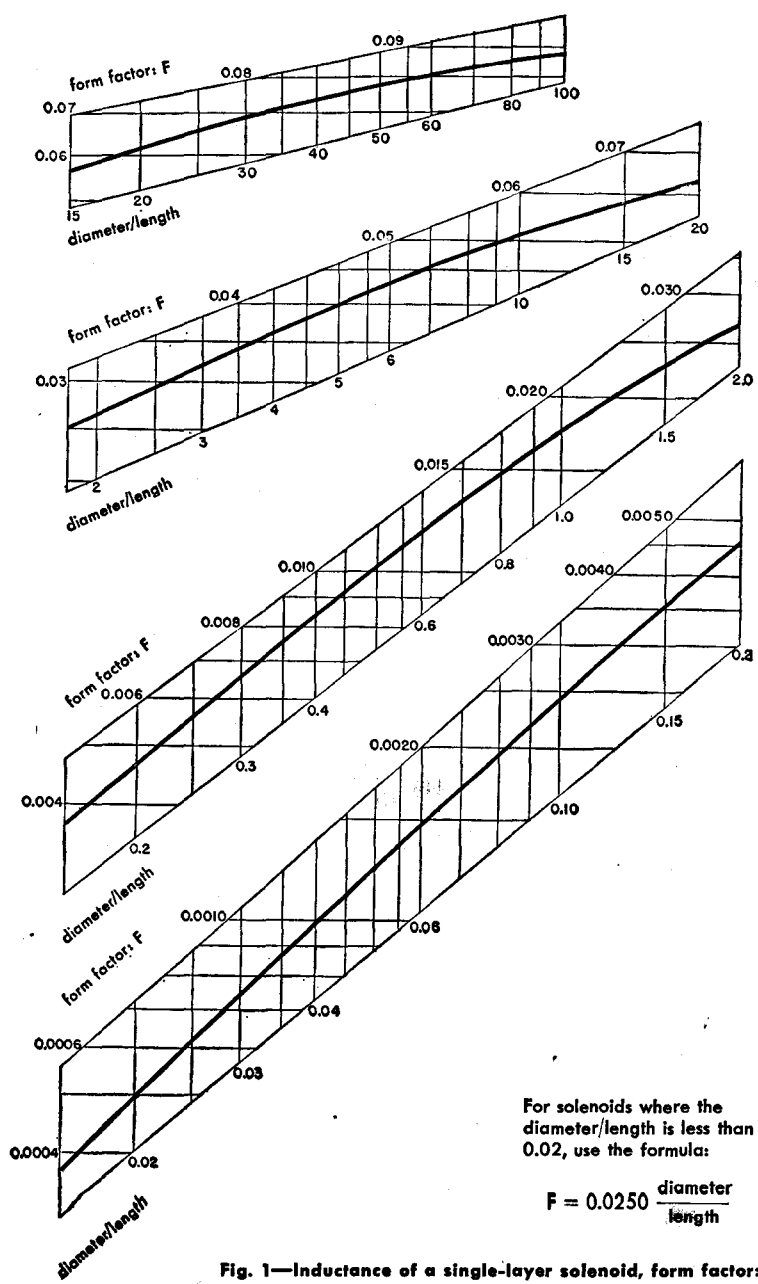

For solenoids where the diameter/length is less than 0.02, use the formula:

$$F = 0.0250 \frac{\text{diameter}}{\text{length}}$$

Fig. 1—Inductance of a single-layer solenoid, form factor: F

Magnet wire data

size wire AWG	bare nom diam in inches	enam nom diam in inches	SCC* diam in inches	DCC* diam in inches	SCE* diam in inches	SSC* diam in inches	DSC* diam in inches	SSE* diam in inches	bare		enameled	
									min diam inches	max diam inches	min diam inches	diam* in inches
10	.1019	.1039	.1079	.1129	.1104				.1009	.1029	.1024	.1044
11	.0907	.0927	.0957	.1002	.0982				.0898	.0917	.0913	.0932
12	.0808	.0827	.0858	.0903	.0882				.0800	.0816	.0814	.0832
13	.0720	.0738	.0770	.0815	.0793				.0712	.0727	.0726	.0743
14	.0641	.0659	.0691	.0736	.0714				.0634	.0647	.0648	.0664
15	.0571	.0588	.0621	.0666	.0643	.0591	.0611	.0613	.0565	.0576	.0578	.0593
16	.0508	.0524	.0558	.0603	.0579	.0528	.0548	.0549	.0503	.0513	.0515	.0529
17	.0453	.0469	.0503	.0548	.0523	.0473	.0493	.0493	.0448	.0457	.0460	.0473
18	.0403	.0418	.0453	.0498	.0472	.0423	.0443	.0442	.0399	.0407	.0410	.0422
19	.0359	.0374	.0409	.0454	.0428	.0379	.0399	.0398	.0355	.0363	.0366	.0378
20	.0320	.0334	.0370	.0415	.0388	.0340	.0360	.0358	.0316	.0323	.0326	.0338
21	.0285	.0299	.0335	.0380	.0353	.0305	.0325	.0323	.0282	.0287	.0292	.0303
22	.0253	.0266	.0303	.0343	.0320	.0273	.0293	.0290	.0251	.0256	.0261	.0270
23	.0226	.0238	.0276	.0316	.0292	.0246	.0266	.0262	.0223	.0228	.0232	.0242
24	.0201	.0213	.0251	.0291	.0266	.0221	.0241	.0236	.0199	.0203	.0208	.0216
25	.0179	.0190	.0224	.0264	.0238	.0199	.0219	.0213	.0177	.0181	.0186	.0193
26	.0159	.0169	.0204	.0244	.0217	.0179	.0199	.0192	.0158	.0161	.0166	.0172
27	.0142	.0152	.0187	.0227	.0200	.0162	.0182	.0175	.0141	.0144	.0149	.0155
28	.0126	.0135	.0171	.0211	.0183	.0146	.0166	.0158	.0125	.0128	.0132	.0138
29	.0113	.0122	.0158	.0198	.0170	.0133	.0153	.0145	.0112	.0114	.0119	.0125
30	.0100	.0108	.0145	.0185	.0156	.0120	.0140	.0131	.0099	.0101	.0105	.0111
31	.0089	.0097	.0134	.0174	.0144	.0109	.0129	.0119	.0088	.0090	.0094	.0099
32	.0080	.0088	.0125	.0165	.0135	.0100	.0120	.0110	.0079	.0081	.0085	.0090
33	.0071	.0078	.0116	.0156	.0125	.0091	.0111	.0100	.0070	.0072	.0075	.0080
34	.0063	.0069	.0108	.0148	.0116	.0083	.0103	.0091	.0062	.0064	.0067	.0071
35	.0056	.0061	.0101	.0141	.0108	.0076	.0096	.0083	.0055	.0057	.0059	.0063
36	.0050	.0055	.0090	.0130	.0097	.0070	.0090	.0077	.0049	.0051	.0053	.0057
37	.0045	.0049	.0085	.0125	.0091	.0065	.0085	.0071	.0044	.0046	.0047	.0051
38	.0040	.0044	.0080	.0120	.0086	.0060	.0080	.0066	.0039	.0041	.0042	.0046
39	.0035	.0038	.0075	.0115	.0080	.0055	.0075	.0060	.0034	.0036	.0036	.0040
40	.0031	.0034	.0071	.0111	.0076	.0051	.0071	.0056	.0030	.0032	.0032	.0036
41	.0028	.0031							.0027	.0029	.0029	.0032
42	.0025	.0028							.0024	.0026	.0026	.0029
43	.0022	.0025							.0021	.0023	.0023	.0026
44	.0020	.0023							.0019	.0021	.0021	.0024

* Nominal bare diameter plus maximum additions.
For additional data on copper wire, see pages 35, 36, and 126.

Reactance charts

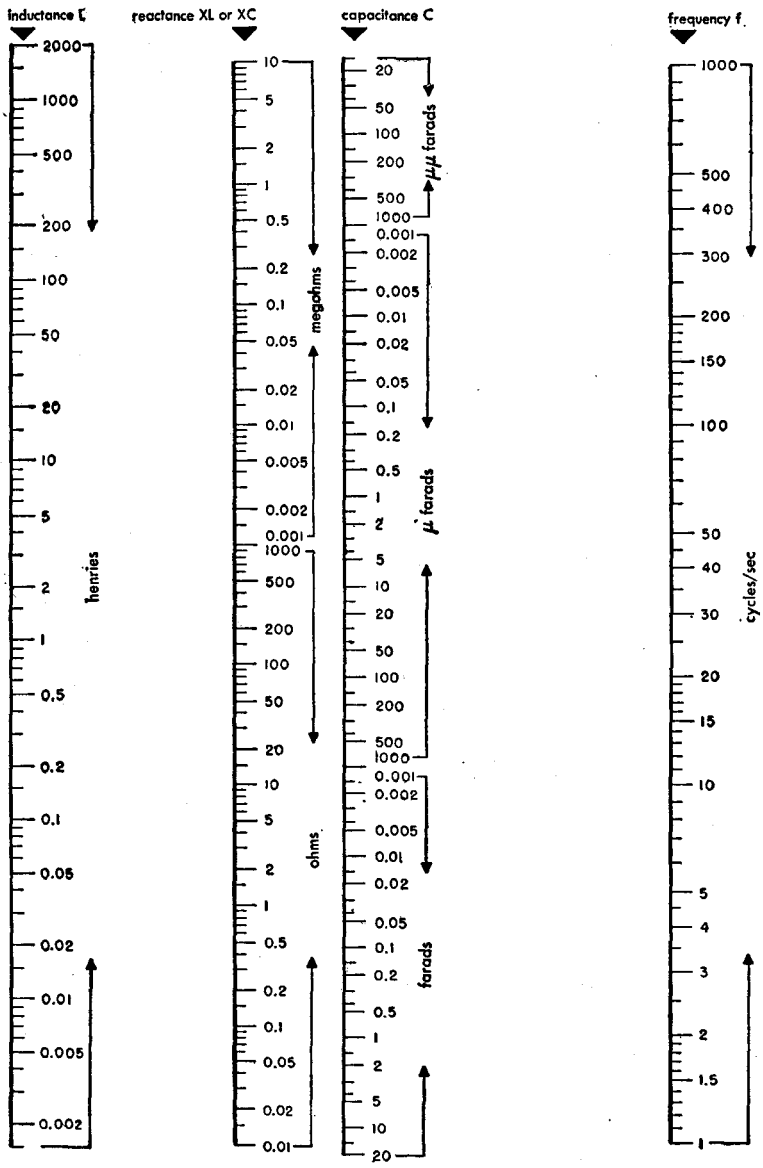

Figs 2, 3, and 4 give the relationships of capacitance, inductance, reactance, and frequency. Any one value may be determined in terms of two others by use of a straight edge laid across the correct chart for the frequency under consideration.

Fig. 2—1 cycle to 1000 cycles.

Reactance charts *continued*

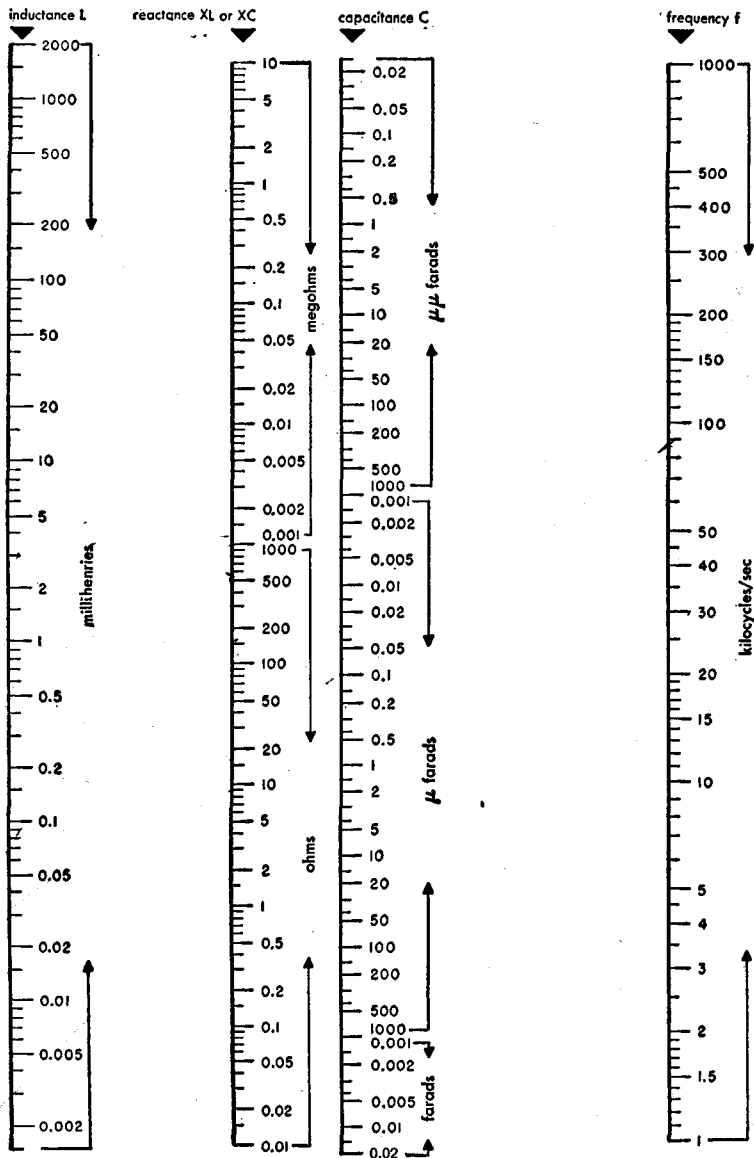

Example: Given a capacitance of $0.001 \mu f$, find the reactance at 50 kilocycles and inductance required to resonate. Place a straight edge through these values and read the intersections on the other scales, giving 3,180 ohms and 10.1 millihenries.

Fig. 3—1 kilocycle to 1000 kilocycles.

Reactance charts *continued*

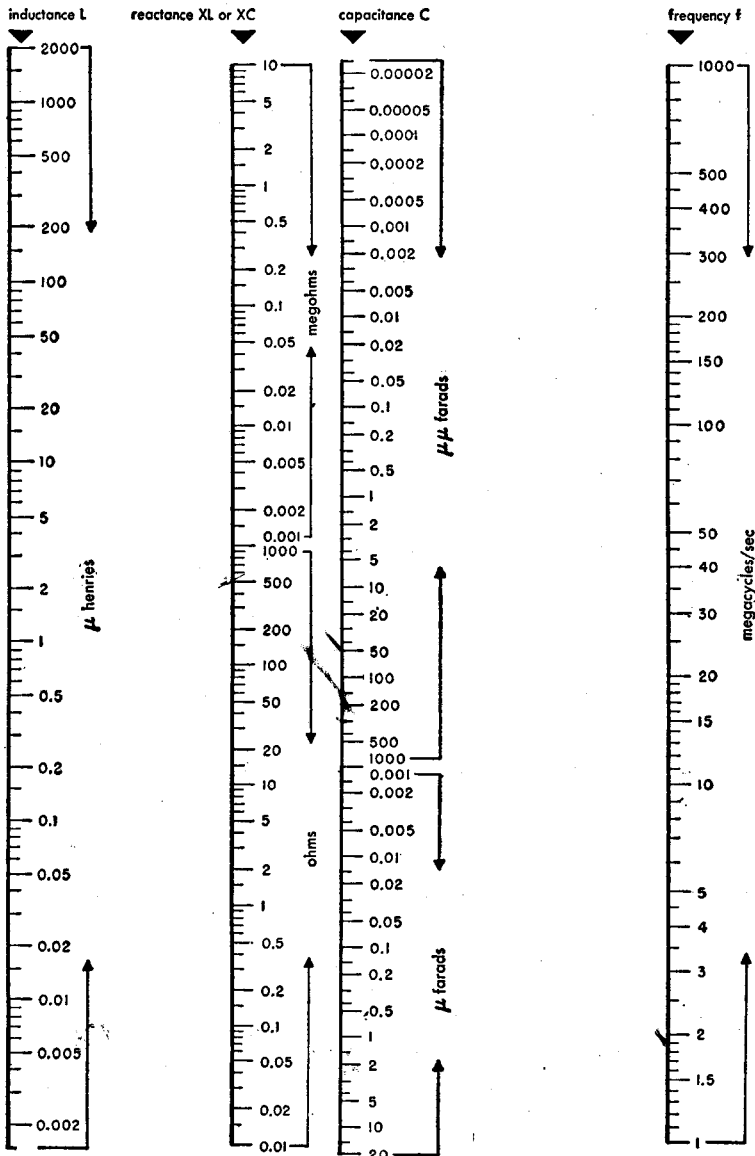

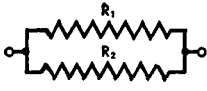
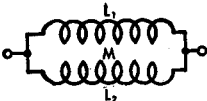
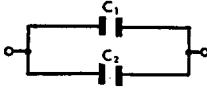
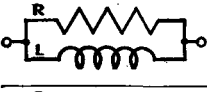
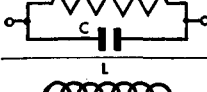
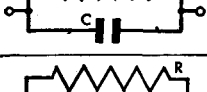
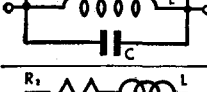

Fig. 4-1 megacycle to 1000 megacycles.

Impedance formulasimpedance $Z = R + jX$ ohmsmagnitude $|Z| = [R^2 + X^2]^{\frac{1}{2}}$ ohmsphase angle $\phi = \tan^{-1} \frac{X}{R}$ admittance $Y = \frac{1}{Z}$ mhos

phase angle of the admittance

is $-\tan^{-1} \frac{X}{R}$

diagram	impedance	magnitude	phase angle	admittance
	R	R	0	$\frac{1}{R}$
	$j\omega L$	ωL	$+\frac{\pi}{2}$	$-j\frac{1}{\omega L}$
	$-j\frac{1}{\omega C}$	$\frac{1}{\omega C}$	$-\frac{\pi}{2}$	$j\omega C$
	$j\omega (L_1 + L_2 \pm 2M)$	$\omega (L_1 + L_2 \pm 2M)$	$+\frac{\pi}{2}$	$-j\frac{1}{\omega (L_1 + L_2 \pm 2M)}$
	$-j\frac{1}{\omega} \left(\frac{1}{C_1} + \frac{1}{C_2} \right)$	$\frac{1}{\omega} \left(\frac{1}{C_1} + \frac{1}{C_2} \right)$	$-\frac{\pi}{2}$	$j\omega \frac{C_1 C_2}{C_1 + C_2}$
	$R + j\omega L$	$[R^2 + \omega^2 L^2]^{\frac{1}{2}}$	$\tan^{-1} \frac{\omega L}{R}$	$\frac{R - j\omega L}{R^2 + \omega^2 L^2}$
	$R - j\frac{1}{\omega C}$	$\frac{1}{\omega C} [1 + \omega^2 C^2 R^2]^{\frac{1}{2}}$	$-\tan^{-1} \frac{1}{\omega C R}$	$\frac{R + j\frac{1}{\omega C}}{R^2 + \frac{1}{\omega^2 C^2}}$
	$j \left(\omega L - \frac{1}{\omega C} \right)$	$\left(\omega L - \frac{1}{\omega C} \right)$	$\pm \frac{\pi}{2}$	$j \frac{\omega C}{1 - \omega^2 L C}$
	$R + j \left(\omega L - \frac{1}{\omega C} \right)$	$[R^2 + \left(\omega L - \frac{1}{\omega C} \right)^2]^{\frac{1}{2}}$	$\tan^{-1} \frac{\left(\omega L - \frac{1}{\omega C} \right)}{R}$	$\frac{R - j \left(\omega L - \frac{1}{\omega C} \right)}{R^2 + \left(\omega L - \frac{1}{\omega C} \right)^2}$

	$\frac{R_1 R_2}{R_1 + R_2}$	$\frac{R_1 R_2}{R_1 + R_2}$	0	$\left(\frac{1}{R_1} + \frac{1}{R_2}\right)$
	$j\omega \left[\frac{L_1 L_2 - M^2}{L_1 + L_2 \mp 2M} \right]$	$\omega \left[\frac{L_1 L_2 - M^2}{L_1 + L_2 \mp 2M} \right]$	$+\frac{\pi}{2}$	$-j \frac{1}{\omega} \left[\frac{L_1 + L_2 \mp 2M}{L_1 L_2 - M^2} \right]$
	$-j \frac{1}{\omega (C_1 + C_2)}$	$\frac{1}{\omega (C_1 + C_2)}$	$-\frac{\pi}{2}$	$j\omega (C_1 + C_2)$
	$\omega L R \left[\frac{\omega L + jR}{R^2 + \omega^2 L^2} \right]$	$\frac{\omega L R}{[R^2 + \omega^2 L^2]^{\frac{1}{2}}}$	$\tan^{-1} \frac{R}{\omega L}$	$\frac{1}{R} - j \frac{1}{\omega L}$
	$\frac{R(1 - j\omega CR)}{1 + \omega^2 C^2 R^2}$	$\frac{R}{[1 + \omega^2 C^2 R^2]^{\frac{1}{2}}}$	$-\tan^{-1} \omega CR$	$\frac{1}{R} + j\omega C$
	$j \frac{\omega L}{1 - \omega^2 LC}$	$\frac{\omega L}{1 - \omega^2 LC}$	$\pm \frac{\pi}{2}$	$j \left(\omega C - \frac{1}{\omega L} \right)$
	$\frac{\frac{1}{R} - j \left(\omega C - \frac{1}{\omega L} \right)}{\left(\frac{1}{R} \right)^2 + \left(\omega C - \frac{1}{\omega L} \right)^2}$	$\frac{1}{\left[\left(\frac{1}{R} \right)^2 + \left(\omega C - \frac{1}{\omega L} \right)^2 \right]^{\frac{1}{2}}}$	$\tan^{-1} R \left(\frac{1}{\omega L} - \omega C \right)$	$\frac{1}{R} + j \left(\omega C - \frac{1}{\omega L} \right)$
	$R_2 \frac{R_1 (R_1 + R_2) + \omega^2 L^2 + j\omega L R_2}{(R_1 + R_2)^2 + \omega^2 L^2}$	$R_2 \left[\frac{R_1^2 + \omega^2 L^2}{(R_1 + R_2)^2 + \omega^2 L^2} \right]^{\frac{1}{2}}$	$\tan^{-1} \frac{\omega L R_2}{R_1 (R_1 + R_2) + \omega^2 L^2}$	$\frac{R_1 (R_1 + R_2) + \omega^2 L^2 - j\omega L R_2}{R_2 (R_1^2 + \omega^2 L^2)}$

continued Impedance formulasimpedance $\bar{Z} = R + jX$ ohmsphase angle $\phi = \tan^{-1} \frac{X}{R}$

phase angle of the admittance

magnitude $|Z| = [R^2 + X^2]^{\frac{1}{2}}$ ohmsadmittance $Y = \frac{1}{Z}$ mhosis $-\tan^{-1} \frac{X}{R}$

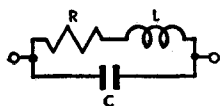
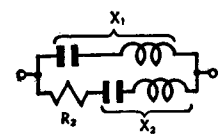
	impedance	$\frac{R + j\omega[L(1 - \omega^2 LC) - CR^2]}{(1 - \omega^2 LC)^2 + \omega^2 C^2 R^2}$
	magnitude	$\left[\frac{R^2 + \omega^2 L^2}{(1 - \omega^2 LC)^2 + \omega^2 C^2 R^2} \right]^{\frac{1}{2}}$
	phase angle	$\tan^{-1} \frac{\omega[L(1 - \omega^2 LC) - CR^2]}{R}$
	admittance	$\frac{R - j\omega[L(1 - \omega^2 LC) - CR^2]}{R^2 + \omega^2 L^2}$
	impedance	$X_1 \frac{X_1 R_2 + j[R_2^2 + X_2(X_1 + X_2)]}{R_2^2 + (X_1 + X_2)^2}$
	magnitude	$X_1 \left[\frac{R_2^2 + X_2^2}{R_2^2 + (X_1 + X_2)^2} \right]^{\frac{1}{2}}$
	phase angle	$\tan^{-1} \frac{R_2^2 + X_2(X_1 + X_2)}{X_1 R_2}$
	admittance	$\frac{R_2 X_1 - j(R_2^2 + X_2^2 + X_1 X_2)}{X_1 (R_2^2 + X_2^2)}$

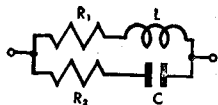
impedance

$$\frac{R_1 R_2 (R_1 + R_2) + \omega^2 L^2 R_2 + \frac{R_1}{\omega^2 C^2}}{(R_1 + R_2)^2 + \left(\omega L - \frac{1}{\omega C}\right)^2} + j \frac{\omega L R_2^2 - \frac{R_1^2}{\omega C} - \frac{L}{C} \left(\omega L - \frac{1}{\omega C}\right)}{(R_1 + R_2)^2 + \left(\omega L - \frac{1}{\omega C}\right)^2}$$

magnitude

$$\left[\frac{(R_1^2 + \omega^2 L^2) \left(R_2^2 + \frac{1}{\omega^2 C^2}\right)}{(R_1 + R_2)^2 + \left(\omega L - \frac{1}{\omega C}\right)^2} \right]^{\frac{1}{2}}$$

phase angle

$$\tan^{-1} \left[\frac{\omega L R_2^2 - \frac{R_1^2}{\omega C} - \frac{L}{C} \left(\omega L - \frac{1}{\omega C}\right)}{R_1 R_2 (R_1 + R_2) + \omega^2 L^2 R_2 + \frac{R_1}{\omega^2 C^2}} \right]$$

admittance

$$\frac{R_1 + \omega^2 C^2 R_1 R_2 (R_1 + R_2) + \omega^4 L^2 C^2 R_2}{(R_1^2 + \omega^2 L^2) (1 + \omega^2 C^2 R_2^2)} + j \omega \left[\frac{C R_1^2 - L + \omega^2 L C (L - C R_2^2)}{(R_1^2 + \omega^2 L^2) (1 + \omega^2 C^2 R_2^2)} \right]$$

impedance

$$\frac{R_1 R_2 (R_1 + R_2) + R_1 X_2^2 + R_2 X_1^2}{(R_1 + R_2)^2 + (X_1 + X_2)^2} + j \frac{R_1^2 X_2 + R_2^2 X_1 + X_1 X_2 (X_1 + X_2)}{(R_1 + R_2)^2 + (X_1 + X_2)^2}$$

magnitude

$$\left[\frac{(R_1^2 + X_1^2) (R_2^2 + X_2^2)}{(R_1 + R_2)^2 + (X_1 + X_2)^2} \right]^{\frac{1}{2}}$$

phase angle

$$\tan^{-1} \frac{R_1^2 X_2 + R_2^2 X_1 + X_1 X_2 (X_1 + X_2)}{R_1 R_2 (R_1 + R_2) + R_1 X_2^2 + R_2 X_1^2}$$

admittance

$$\frac{R_1 (R_2^2 + X_2^2) + R_2 (R_1^2 + X_1^2)}{(R_1^2 + X_1^2) (R_2^2 + X_2^2)} - j \frac{X_1 (R_2^2 + X_2^2) + X_2 (R_1^2 + X_1^2)}{(R_1^2 + X_1^2) (R_2^2 + X_2^2)}$$

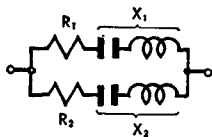

Impedance formulas *continued***Parallel and series circuits and their equivalent relationships**

$$\text{Conductance } G = \frac{1}{R_p} \quad \omega = 2\pi f$$

$$\text{Susceptance } B = \frac{1}{X_p} = \frac{1}{\omega L_p} - \omega C_p$$

$$\text{Reactance } X_p = \frac{\omega L_p}{1 - \omega^2 L_p C_p}$$

$$\text{Admittance } Y = \frac{I}{E} = \frac{1}{Z} = G - jB$$

$$= \sqrt{G^2 + B^2} \angle -\phi = |Y| \angle -\phi$$

$$\text{Impedance } Z = \frac{E}{I} = \frac{1}{Y} = \frac{R_p X_p}{R_p^2 + X_p^2} (X_p + jR_p)$$

$$= \frac{R_p X_p}{\sqrt{R_p^2 + X_p^2}} \angle \phi = |Z| \angle \phi$$

$$\text{Phase angle } -\phi = \tan^{-1} \frac{-B}{G} = \cos^{-1} \frac{G}{|Y|} = -\tan^{-1} \frac{R_p}{X_p}$$

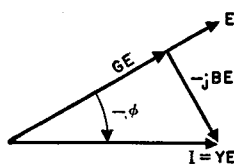
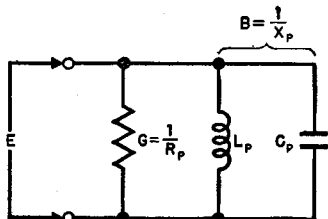

parallel circuit

$$\text{Resistance} = R_s$$

$$\text{Reactance } X_s = \omega L_s - \frac{1}{\omega C_s}$$

$$\text{Impedance } Z = \frac{E}{I} = R_s + jX_s$$

$$= \sqrt{R_s^2 + X_s^2} \angle \phi = |Z| \angle \phi$$

$$\text{Phase angle } \phi = \tan^{-1} \frac{X_s}{R_s} = \cos^{-1} \frac{R_s}{|Z|}$$

Vectors E and I , phase angle ϕ , and Z , Y are identical for the parallel circuit and its equivalent series circuit

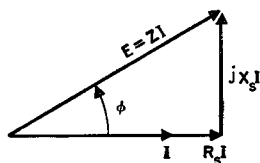
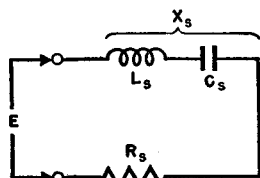

equivalent series circuit

$$Q = |\tan \phi| = \frac{|X_s|}{R_s} = \frac{R_p}{|X_p|} = \frac{|B|}{G}$$

$$\text{PF} = \cos \phi = \frac{R_s}{|Z|} = \frac{|Z|}{R_p} = \frac{G}{|Y|} = \sqrt{\frac{R_s}{R_p}} = \frac{1}{\sqrt{Q^2 + 1}} = \frac{\text{kW}}{\text{kva}}$$

$$Z^2 = R_s^2 + X_s^2 = \frac{R_p^2 X_p^2}{R_p^2 + X_p^2} = R_s R_p = X_s X_p$$

Impedance formulas *continued*

$$Y^2 = G^2 + B^2 = \frac{1}{R_p^2} + \frac{1}{X_p^2} = \frac{G}{R_s}$$

$$R_s = \frac{Z^2}{R_p} = \frac{G}{Y^2} = R_p \frac{X_p^2}{R_p^2 + X_p^2} = R_p \frac{1}{Q^2 + 1}$$

$$X_s = \frac{Z^2}{X_p} = \frac{B}{Y^2} = X_p \frac{R_p^2}{R_p^2 + X_p^2} = X_p \frac{1}{1 + \frac{1}{Q^2}}$$

$$R_p = \frac{1}{G} = \frac{Z^2}{R_s} = \frac{R_s^2 + X_s^2}{R_s} = R_s (Q^2 + 1)$$

$$X_p = \frac{1}{B} = \frac{Z^2}{X_s} = \frac{R_s^2 + X_s^2}{X_s} = X_s \left(1 + \frac{1}{Q^2} \right) = \frac{R_s R_p}{X_s} = \pm R_p \sqrt{\frac{R_s}{R_p - R_s}}$$

Approximate formulas

Reactor $R_s = \frac{X^2}{R_p}$ and $X = X_s = X_p$ (See Note 1)

Resistor $R = R_s = R_p$ and $X_s = \frac{R^2}{X_p}$ (See Note 2)

Simplified parallel and series circuits

$$X_p = \omega L_p \quad B = \frac{1}{\omega L_p} \quad X_s = \omega L_s$$

$$\tan \phi = \frac{\omega L_s}{R_s} = \frac{R_p}{\omega L_p} \quad Q = \frac{\omega L_s}{R_s} = \frac{R_p}{\omega L_p}$$

$$PF = \frac{R_s}{\sqrt{R_s^2 + \omega^2 L_s^2}} = \frac{\omega L_p}{\sqrt{R_p^2 + \omega^2 L_p^2}}$$

$$PF = \frac{1}{Q} \text{ approx} \quad (\text{See Note 3})$$

$$R_s = R_p \frac{1}{Q^2 + 1} \quad R_p = R_s (Q^2 + 1)$$

$$L_s = L_p \frac{1}{1 + \frac{1}{Q^2}} \quad L_p = L_s \left(1 + \frac{1}{Q^2} \right)$$

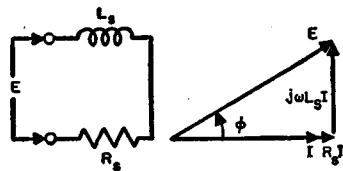
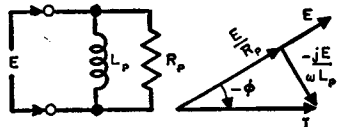

Impedance formulas *continued*

$$X_p = \frac{-1}{\omega C_p} \quad B = -\omega C_p \quad X_s = \frac{-1}{\omega C_s}$$

$$\tan \phi = \frac{-1}{\omega C_s R_s} = -\omega C_p R_p$$

$$Q = \frac{1}{\omega C_s R_s} = \omega C_p R_p$$

$$PF = \frac{\omega C_s R_s}{\sqrt{1 + \omega^2 C_s^2 R_s^2}} = \frac{1}{\sqrt{1 + \omega^2 C_p^2 R_p^2}}$$

$$PF = \frac{1}{Q} \text{ approx (See Note 3)}$$

$$R_s = R_p \frac{1}{Q^2 + 1} \quad R_p = R_s (Q^2 + 1)$$

$$C_s = C_p \left(1 + \frac{1}{Q^2}\right) \quad C_p = C_s \frac{1}{1 + \frac{1}{Q^2}}$$

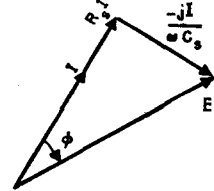
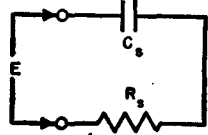
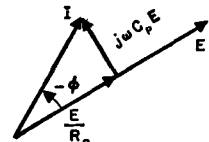
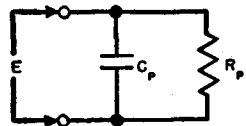
**Approximate formulas**

Inductor $R_s = \frac{\omega^2 L^2}{R_p}$ and $L = L_p = L_s$ (See Note 1)

Resistor $R = R_s = R_p$ and $L_p = \frac{R^2}{\omega^2 L_s}$ (See Note 2)

Capacitor $R_s = \frac{1}{\omega^2 C^2 R_p}$ and $C = C_p = C_s$ (See Note 1)

Resistor $R = R_s = R_p$ and $C_s = \frac{1}{\omega^2 C_p R^2}$ (See Note 2)

Note 1: (Small resistive component) Error in percent = $-\frac{100}{Q^2}$ (for $Q = 10$, error = 1 percent low)

Note 2: (Small reactive component) Error in percent = $-100 Q^2$ (for $Q = 0.1$, error = 1 percent low)

Note 3: Error in percent = $+\frac{50}{Q^2}$ approximately (for $Q = 7$, error = 1 percent high)

Skin effect

- A = correction coefficient
- D = diameter of conductor in inches
- f = frequency in cycles per second
- R_{ac} = resistance at frequency f
- R_{dc} = direct-current resistance
- T = thickness of tubular conductor in inches
- T_1 = depth of penetration of current
- μ = permeability of conductor material ($\mu = 1$ for copper and other nonmagnetic materials)
- ρ = resistivity of conductor material at any temperature
- ρ_c = resistivity of copper at 20°C (1.724 microhm-centimeter)

Fig. 5 shows the relationship of R_{ac}/R_{dc} versus $D\sqrt{f}$ for copper, or versus $D\sqrt{f}\sqrt{\mu\frac{\rho_c}{\rho}}$ for any conductor material, for an isolated straight solid conductor of circular cross section. Negligible error in the formulas for R_{ac} results when the conductor is spaced at least 10D from adjacent conductors. When the spacing between axes of parallel conductors carrying the same current is 4D, the resistance R_{ac} is increased about 3 percent. The formulas are accurate for concentric lines due to their circular symmetry.

For values of $D\sqrt{f}\sqrt{\mu\frac{\rho_c}{\rho}}$ greater than 40,

$$\frac{R_{ac}}{R_{dc}} = 0.0960 D\sqrt{f}\sqrt{\mu\frac{\rho_c}{\rho}} + 0.26 \tag{1}$$

The high-frequency resistance of an isolated straight conductor: either solid; or tubular for $T < \frac{D}{8}$ or $T_1 < \frac{D}{8}$; is given in equation (2). If the current flow is along the inside surface of a tubular conductor, D is the inside diameter.

$$R_{ac} = A \frac{\sqrt{f}}{D} \sqrt{\mu\frac{\rho}{\rho_c}} \times 10^{-6} \text{ ohms per foot} \tag{2}$$

The values of the correction coefficient A for solid conductors are shown in Table II and, for tubular conductors, in Table III.

The value of $T\sqrt{f}\sqrt{\mu\frac{\rho_c}{\rho}}$ that just makes $A = 1$ indicates the penetration of

Skin effect *continued*

Fig. 5—Resistance ratio for isolated straight solid conductors of circular cross section.

Skin effect *continued*

the currents below the surface of the conductor. Thus, approximately,

$$T_1 = \frac{3.5}{\sqrt{f}} \sqrt{\frac{\rho}{\mu \rho_c}} \text{ inches.} \tag{3}$$

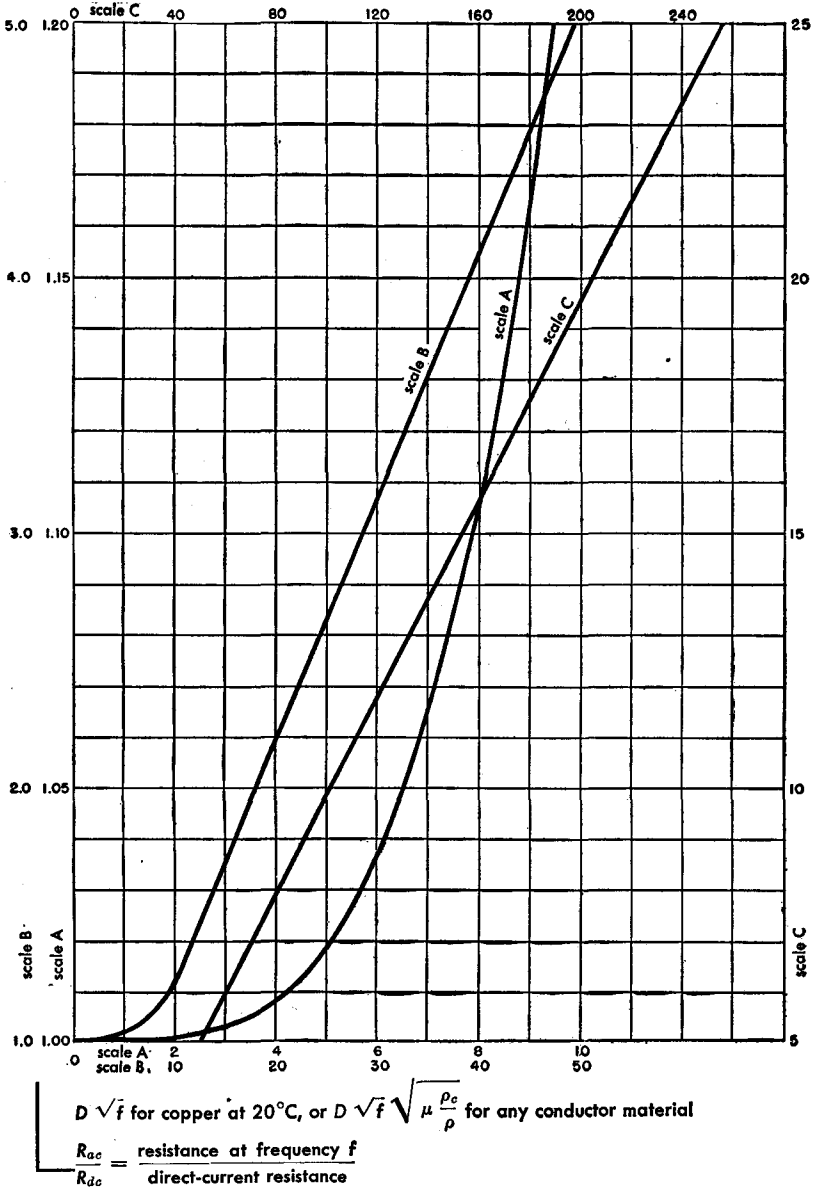
When $T_1 < \frac{D}{8}$ the value of R_{ac} as given by equation (2) (but not the value of $\frac{R_{ac}}{R_{dc}}$ in Table III) is correct for any value $T \geq T_1$.

Under the limitation that the radius of curvature of all parts of the cross section is appreciably greater than T_1 , equations (2) and (3) hold for isolated straight conductors of any shape. In this case the term $D =$ (perimeter of cross section) $\div \pi$.

Examples

1. At 100 megacycles, a copper conductor has a depth of penetration $T_1 = 0.00035$ inch.

2. A steel shield with 0.005-inch copper plate, which is practically equivalent in R_{ac} to an isolated copper conductor 0.005-inch thick, has a value of $A = 1.23$ at 200 kilocycles. This 23-percent increase in resistance over that of a thick copper sheet is satisfactorily low as regards its effect on the losses of the components within the shield. By comparison, a thick aluminum sheet

has a resistance $\sqrt{\frac{\rho}{\rho_c}} = 1.28$ times that of copper.

Table II—Solid conductors

$D \sqrt{f} \sqrt{\mu \frac{\rho_c}{\rho}}$	A
> 370	1.000
220	1.005
160	1.010
98	1.02
48	1.05
26	1.10
13	1.20
9.6	1.30
5.3	2.00
< 3.0	$R_{ac} \approx R_{dc}$

$$R_{dc} = \frac{10.37}{D^2} \frac{\rho}{\rho_c} \times 10^{-8} \text{ ohms per foot}$$

Table III—Tubular conductors

$T \sqrt{f} \sqrt{\mu \frac{\rho_c}{\rho}}$	A	R_{ac}/R_{dc}
= B where } B > 3.5	1.00	0.384 B
	3.5	1.00
	3.15	1.01
	2.85	1.05
	2.60	1.10
2.29	1.20	1.06
2.08	1.30	1.04
1.77	1.50	1.02
1.31	2.00	1.00
= B where } B < 1.3	2.60	1.00
	B	

Network theorems

Reciprocity theorem

If an emf of any character whatsoever located at one point in a linear network produces a current at any other point in the network, the same emf acting at the second point will produce the same current at the first point.

Thévenin's theorem

If an impedance Z is connected between two points of a linear network, the resulting steady-state current I through this impedance is the ratio of the potential difference V between the two points prior to the connection of Z , and the sum of the values of (1) the connected impedance Z , and (2) the impedance Z_1 of the network measured between the two points, when all generators in the network are replaced by their internal impedances

$$I = \frac{V}{Z + Z_1}$$

Principle of superposition

The current which flows at any point in a network composed of constant resistances, inductances, and capacitances, or the potential difference which exists between any two points in such a network, due to the simultaneous action of a number of emf's distributed in any manner throughout the network, is the sum of the component currents at the first point, or the potential differences between the two points, which would be caused by the individual emf's acting alone. (Applicable to emf's of any character.)

In the application of this theorem, it is to be noted that: for any impedance element Z through which flows a current I , there may be substituted a virtual source of voltage of value $-ZI$.

Electrical circuit formulas

1. Self-inductance of circular ring of round wire at radio frequencies, for non-magnetic materials

$$L = \frac{\alpha}{100} \left[7.353 \log_{10} \frac{16\alpha}{d} - 6.370 \right]$$

L = inductance in microhenries

α = mean radius of ring in inches

d = diameter of wire in inches

$$\frac{\alpha}{d} > 2.5$$

Electrical circuit formulas *continued***2. Capacitance of a parallel-plate capacitor**

$$C = 0.0885 K \frac{(N - 1) A}{t} \text{ micromicrofarads}$$

A = area of one side of one plate in square centimeters

N = number of plates

t = thickness of dielectric in centimeters

K = dielectric constant

This formula neglects "fringing" at the edges of the plates.

3. Reactance of an inductor

$$X = 2\pi fL \text{ ohms}$$

f = frequency in cycles per second

L = inductance in henries

or f in kilocycles and L in millihenries; or f in megacycles and L in microhenries

4. Reactance of a capacitor

$$X = \frac{-1}{2\pi fC} \text{ ohms}$$

f = frequency in cycles per second

C = capacitance in farads

$$\text{This may be written } X = \frac{-159.2}{fC} \text{ ohms}$$

f = frequency in kilocycles per second

C = capacitance in microfarads

or f in megacycles and C in milli-microfarads ($0.001\mu\text{f}$).

5. Resonant frequency of a series-tuned circuit

$$f = \frac{1}{2\pi\sqrt{LC}} \text{ cycles per second}$$

L = inductance in henries.

C = capacitance in farads

$$\text{This may be written } LC = \frac{25,330}{f^2}$$

f = frequency in kilocycles

L = inductance in millihenries

C = capacitance in milli-microfarads ($0.001\mu\text{f}$)

or f in megacycles, L in microhenries, and C in micromicrofarads.

Electrical circuit formulas *continued***6. Dynamic resistance of a parallel-tuned circuit at resonance**

$$r = \frac{X^2}{R} = \frac{L}{CR} \text{ ohms}$$

$$X = \omega L = \frac{1}{\omega C}$$

$$R = r_1 + r_2$$

L = inductance in henries

C = capacitance in farads

R = resistance in ohms

The formula is accurate for engineering

purposes provided $\frac{X}{R} > 10$.

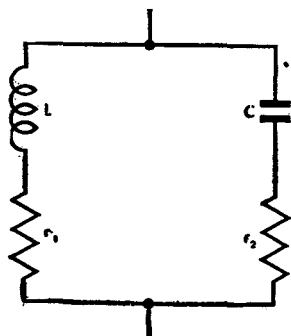
**7. Parallel impedances**

If Z_1 and Z_2 are the two impedances which are connected in parallel, then the resultant impedance is

$$Z = \frac{Z_1 Z_2}{Z_1 + Z_2} = \frac{(R_1 + jX_1)(R_2 + jX_2)}{(R_1 + R_2) + j(X_1 + X_2)} = \frac{(R_1 R_2 - X_1 X_2) + j(R_1 X_2 + R_2 X_1)}{(R_1 + R_2) + j(X_1 + X_2)}$$

$$Z = \frac{|Z_1| |Z_2|}{|Z_1 + Z_2|} \angle \phi$$

$$\phi = \angle Z_1 + \angle Z_2 - \angle (Z_1 + Z_2)$$

$$= \tan^{-1} \frac{X_1}{R_1} + \tan^{-1} \frac{X_2}{R_2} - \tan^{-1} \frac{X_1 + X_2}{R_1 + R_2}$$

Given one impedance Z_1 and the desired resultant impedance Z , the other impedance is

$$Z_2 = \frac{Z Z_1}{Z_1 - Z}$$

8. Impedance of a two-mesh network

$$Z_{11} = R_{11} + jX_{11}$$

is the impedance of the first circuit, measured at terminals 1 - 1 with terminals 2 - 2 open-circuited.

$$Z_{22} = R_{22} + jX_{22}$$

Electrical circuit formulas *continued*

is the impedance of the second circuit, measured at terminals 2 - 2 with terminals 1 - 1 open-circuited.

$$Z_{12} = R_{12} + jX_{12}$$

is the mutual impedance between the two meshes, i.e., the open-circuit voltage appearing in either mesh when unit current flows in the other mesh.

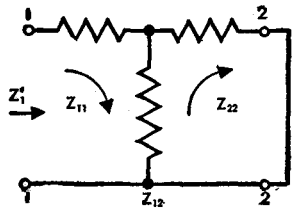

Then the impedance looking into terminals 1 - 1 with terminals 2 - 2 short-circuited is

$$Z_1' = R_1' + jX_1' = Z_{11} - \frac{Z_{12}^2}{Z_{22}} = R_{11} + jX_{11} - \frac{R_{12}^2 - X_{12}^2 + 2jR_{12}X_{12}}{R_{22} + jX_{22}}$$

When

$$R_{12} = 0$$

$$Z_1' = R_1' + jX_1' = Z_{11} + \frac{X_{12}^2}{R_{22}^2 + X_{22}^2} (R_{22} - jX_{22})$$

Example 1: Two resistors in parallel.

$$Z_{11} = R_1 \quad Z_{22} = R_1 + R_2$$

$$Z_{12} = R_1$$

$$\text{Hence } Z_1' = R_1' = R_1 - \frac{R_1^2}{R_1 + R_2} = \frac{R_1 R_2}{R_1 + R_2}$$

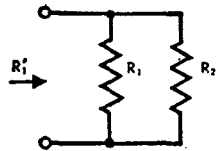

Example 2: A transformer with tuned secondary and negligible primary resistance.

$$Z_{11} = j\omega L_1$$

$$Z_{22} = R_2 \quad \text{since } X_{22} = 0$$

$$Z_{12} = j\omega M$$

$$\text{Then } Z_1' = j\omega L_1 + \frac{\omega^2 M^2}{R_2}$$

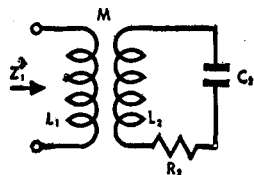

Electrical circuit formulas *continued***9. Currents in a two-mesh network**

$$i_1 = \frac{e_1}{Z_1'}$$

$$= e_1 \frac{Z_{22}}{Z_{11}Z_{22} - Z_{12}^2}$$

$$= e_1 \frac{R_{22} + jX_{22}}{(R_{11}R_{22} - X_{11}X_{22} - R_{12}^2 + X_{12}^2) + j(R_{11}X_{22} + R_{22}X_{11} - 2R_{12}X_{12})}$$

$$i_2 = e_1 \frac{Z_{12}}{Z_{11}Z_{22} - Z_{12}^2}$$

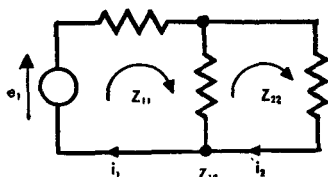
**10. Power transfer between two impedances connected directly**

Let $Z_1 = R_1 + jX_1$ be the impedance of the source, and $Z_2 = R_2 + jX_2$ be the impedance of the load.

The maximum power transfer occurs when

$$R_2 = R_1 \text{ and } X_2 = -X_1$$

The reflection loss due to connecting any two impedances directly is

$$\frac{I_2}{I} = \frac{|Z_1 + Z_2|}{2\sqrt{R_1R_2}}$$

In decibels

$$\text{db} = 20 \log_{10} \frac{|Z_1 + Z_2|}{2\sqrt{R_1R_2}}$$

I_2 = current which would flow in Z_2 were the two impedances connected through a perfect impedance matching network.

I = current which flows when the impedances are connected directly.

11. Power transfer between two meshes coupled reactively

In the general case, X_{11} and X_{22} are not equal to zero and X_{12} may be any reactive coupling. When only one of the quantities X_{11} , X_{22} , and X_{12} can be varied, the best power transfer under the circumstances is given by

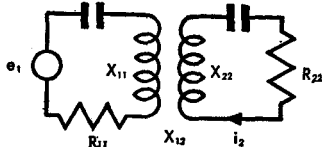

Electrical circuit formulas *continued*

For X_{22} variable

$$X_{22} = \frac{X_{12}^2 X_{11}}{R_{11}^2 + X_{11}^2} \text{ (zero reactance looking into load circuit)}$$

For X_{11} variable

$$X_{11} = \frac{X_{12}^2 X_{22}}{R_{22}^2 + X_{22}^2} \text{ (zero reactance looking into source circuit)}$$

For X_{12} variable

$$X_{12}^2 = \sqrt{(R_{11}^2 + X_{11}^2)(R_{22}^2 + X_{22}^2)}$$

When two of the three quantities can be varied, a perfect impedance match is attained and maximum power is transferred when

$$X_{12}^2 = \sqrt{(R_{11}^2 + X_{11}^2)(R_{22}^2 + X_{22}^2)}$$

and

$$\frac{X_{11}}{R_{11}} = \frac{X_{22}}{R_{22}} \text{ (both circuits of same Q or phase angle)}$$

For perfect impedance match the current is

$$i_2 = \frac{e_1}{2\sqrt{R_{11}R_{22}}} \angle \tan^{-1} \frac{R_{11}}{X_{11}}$$

In the most common case, the circuits are tuned to resonance $X_{11} = 0$ and $X_{22} = 0$. Then $X_{12}^2 = R_{11}R_{22}$ for perfect impedance match.

12. Optimum coupling between two circuits tuned to the same frequency

From the last result in the preceding section, maximum power transfer (or an impedance match) is obtained for $\omega^2 M^2 = R_1 R_2$

where M is the mutual inductance between the circuits, R_1 and R_2 are the resistances of the two circuits.

13. Coefficient of coupling

By definition, coefficient of coupling k is

$$k = \frac{M}{\sqrt{L_1 L_2}} \quad \text{where } M = \text{mutual inductance}$$

L_1 and L_2 are the inductances of the two coupled circuits.

Electrical circuit formulas *continued*

Coefficient of coupling is a geometrical property, being a function of the proportions of the configuration of coils, including their relationship to any nearby objects which affect the field of the system. As long as these proportions remain unchanged, the coefficient of coupling is independent of the physical size of the system, and of the number of turns of either coil.

14. Selective circuits

Formulas and curves are presented for the selectivity and phase shift

Of n single tuned circuits

Of m pairs of coupled tuned circuits

The conditions assumed are

1. All circuits are tuned to the same frequency f_0 .
2. All circuits have the same Q , or each pair of circuits includes one circuit having Q_1 , and the other having Q_2 .
3. Otherwise the circuits need not be identical.
4. Each successive circuit or pair of circuits is isolated from the preceding and following ones by tubes, with no regeneration around the system.

Certain approximations have been made in order to simplify the formulas. In most actual applications of the types of circuits treated, the error involved is negligible from a practical standpoint. Over the narrow frequency band in question, it is assumed that

1. The reactance around each circuit is equal to $2X_0 \frac{\Delta f}{f_0}$.
2. The resistance of each circuit is constant and equal to $\frac{X_0}{Q}$.
3. The coupling between two circuits of a pair is reactive and constant. (When an untuned link is used to couple the two circuits, this condition frequently is far from satisfied, resulting in a lopsided selectivity curve.)
4. The equivalent input voltage, taken as being in series with the tuned circuit (or the first of a pair), is assumed to bear a constant proportionality to the grid voltage of the input tube or other driving source, at all frequencies in the band.
5. Likewise, the output voltage across the circuit (or the final circuit of a pair) is assumed to be proportional only to the current in the circuit.

Electrical circuit formulas *continued*

The following symbols are used in the formulas

$$\frac{\Delta f}{f_0} = \frac{f - f_0}{f_0} = \frac{\text{deviation from resonance frequency}}{\text{resonance frequency}}$$

f = signal frequency

f_0 = frequency to which all circuits are independently tuned

X_0 = reactance at f_0 of inductor in tuned circuit

Q = quality factor of tuned circuit. For a pair of coupled circuits, there is used $Q = \sqrt{Q_1 Q_2}$

Q_1 and Q_2 are the values for the two circuits of a coupled pair

$$Q' = \frac{2Q_1 Q_2}{Q_1 + Q_2}$$

E = amplitude of output voltage at frequency f } both for the same value

E_0 = amplitude of output voltage at frequency f_0 } of input voltage

n = number of single tuned circuits

m = number of pairs of coupled circuits

ϕ = phase shift of signal at f relative to shift at f_0 ,
as signal passes through cascade of circuits

k = coefficient of coupling between two coupled circuits

$p = k^2 Q^2$ or $p = k^2 Q_1 Q_2$, a parameter determining the form of the selectivity curve of coupled circuits

$$B = p - \frac{1}{2} \left(\frac{Q_1}{Q_2} + \frac{Q_2}{Q_1} \right)$$

Selectivity and phase shift of single tuned circuits

$$\frac{E}{E_0} = \left[\frac{1}{\sqrt{1 + \left(2Q \frac{\Delta f}{f_0} \right)^2}} \right]^n$$

$$\frac{\Delta f}{f_0} = \pm \frac{1}{2Q} \sqrt{\left(\frac{E_0}{E} \right)^{\frac{2}{n}} - 1}$$

$$\text{Decibel response} = 20 \log_{10} \left(\frac{E}{E_0} \right)$$

(db response of n circuits) = n times (db response of single circuit)

$$\phi = n \tan^{-1} \left(-2Q \frac{\Delta f}{f_0} \right)$$

These equations are plotted in Fig. 6 and Fig. 7, following.

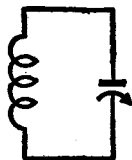

single tuned circuit

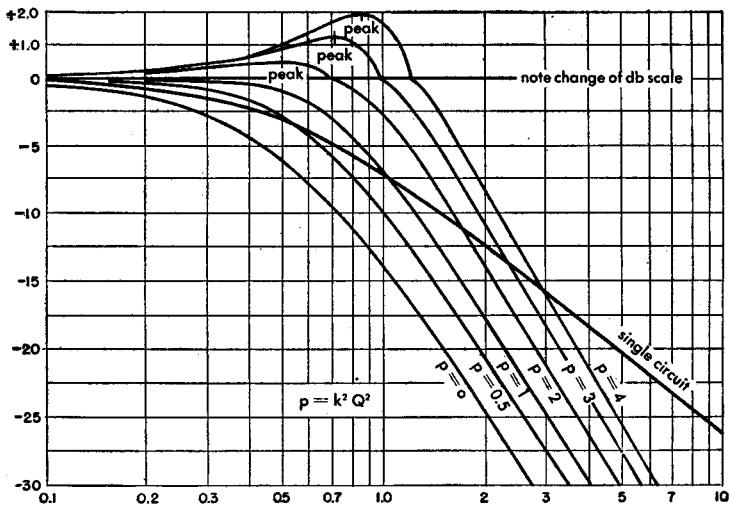
Electrical circuit formulas *continued*

$$Q \frac{\Delta f}{f_0} = Q \frac{f - f_0}{f_0}$$

db response of

- a single circuit $n = 1$
- a pair of coupled circuits $m = 1$

The selectivity curves are symmetrical about the axis $Q \frac{\Delta f}{f_0} = 0$ for practical purposes.

Extrapolation beyond lower limits of chart:

Δ response for doubling Δf	circuit	useful Limit	
		at $\frac{\Delta f}{f_0}$	error becomes
— 6 db	← single →	± 0.3	1 to 2 db
— 12 db	← pair →	± 0.2	3 to 4 db

Fig. 6—Selectivity curves.

As an example of the use of the curves, suppose there are three single-tuned circuits ($n = 3$). Each circuit has a $Q = 200$ and is tuned to 1000 kilocycles. The results of this example are shown in the following table:

abscissa $Q \frac{\Delta f}{f_0}$	Δf kc	ordinate db response for $n = 1$	db response for $n = 3$	ϕ^* for $n = 1$	ϕ^* for $n = 3$
0.5	± 2.5	-3.0	-9	$\mp 45^\circ$	$\mp 135^\circ$
1.5	± 7.5	-10.0	-30	$\mp 71\frac{1}{2}^\circ$	$\mp 215^\circ$
5.0	± 25.0	-20.2	-61	$\mp 84^\circ$	$\mp 252^\circ$

* ϕ is negative for Δf positive, and vice versa.

Electrical circuit formulas *continued*

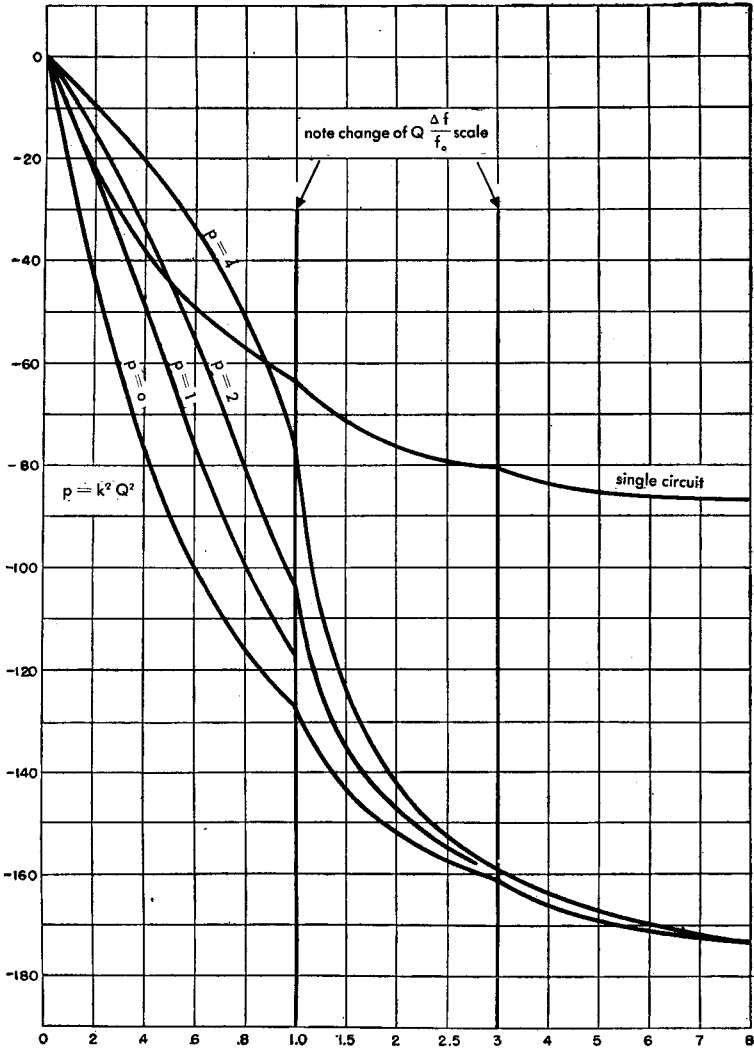

$$Q \frac{\Delta f}{f_0} = Q \frac{f - f_0}{f_0}$$

- relative phase angle ϕ in degrees
- a single circuit $n = 1$
- a pair of coupled circuits $m = 1$

The curves are symmetrical about the origin. For negative values of $Q \frac{\Delta f}{f_0}$, ϕ is positive and same numerical value as for corresponding negative value of $Q \frac{\Delta f}{f_0}$.

Fig. 7—Phase-shift curves.

Electrical circuit formulas *continued***Selectivity and phase shift of pairs of coupled tuned circuits**

Case 1: When $Q_1 = Q_2 = Q$

These formulas can be used with reasonable accuracy when Q_1 and Q_2 differ by ratios up to 1.5 or even 2 to 1. In such cases use the value $Q = \sqrt{Q_1 Q_2}$.

$$\frac{E}{E_0} = \left[\frac{p+1}{\sqrt{\left[\left(2Q \frac{\Delta f}{f_0} \right)^2 - (p-1) \right]^2 + 4p}} \right]^m$$

$$\frac{\Delta f}{f_0} = \pm \frac{1}{2Q} \sqrt{(p-1) \pm \sqrt{(p+1)^2 \left(\frac{E_0}{E} \right)^{\frac{2}{m}} - 4p}}$$

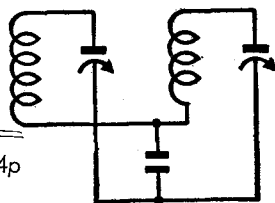

one of several types of coupling

For very small values of $\frac{E}{E_0}$ the formulas reduce to

$$\frac{E}{E_0} = \left[\frac{p+1}{\left(2Q \frac{\Delta f}{f_0} \right)^2} \right]^m$$

$$\text{Decibel response} = 20 \log_{10} \left(\frac{E}{E_0} \right)$$

(db response of m pairs of circuits) = m times (db response of one pair)

$$\phi = m \tan^{-1} \left[\frac{-4Q \frac{\Delta f}{f_0}}{(p+1) - \left(2Q \frac{\Delta f}{f_0} \right)^2} \right]$$

As p approaches zero, the selectivity and phase shift approach the values for n single circuits, where $n = 2m$ (gain also approaches zero).

The above equations are plotted in Figs. 6 and 7.

For overcoupled circuits ($p > 1$)

$$\text{Location of peaks: } \left(\frac{\Delta f}{f_0} \right)_{\text{peak}} = \pm \frac{1}{2Q} \sqrt{p-1}$$

$$\text{Amplitude of peaks: } \left(\frac{E}{E_0} \right)_{\text{peak}} = \left(\frac{p+1}{2\sqrt{p}} \right)^m$$

$$\text{Phase shift at peaks: } \phi_{\text{peak}} = m \tan^{-1} (\mp \sqrt{p-1})$$

Electrical circuit formulas *continued*

Approximate pass band (where $\frac{E}{E_0} = 1$):

$$\left(\frac{\Delta f}{f_0}\right)_{center} = 0 \quad \text{and} \quad \left(\frac{\Delta f}{f_0}\right)_{unity} = \sqrt{2} \left(\frac{\Delta f}{f_0}\right)_{peak} = \pm \frac{1}{Q} \sqrt{\frac{p-1}{2}}$$

Case 2: General formula for any Q_1 and Q_2

$$\frac{E}{E_0} = \left[\frac{p+1}{\sqrt{\left[\left(2Q \frac{\Delta f}{f_0} \right)^2 - B\right]^2 + (p+1)^2 - B^2}} \right]^m$$

$$\frac{\Delta f}{f_0} = \pm \frac{1}{2Q} \sqrt{B \pm \left[(p+1)^2 \left(\frac{E_0}{E} \right)^{\frac{2}{m}} - (p+1)^2 + B^2 \right]^{\frac{1}{2}}}$$

$$\phi = m \tan^{-1} \left[- \frac{2Q \frac{\Delta f}{f_0} \left(\sqrt{\frac{Q_1}{Q_2}} + \sqrt{\frac{Q_2}{Q_1}} \right)}{(p+1) - \left(2Q \frac{\Delta f}{f_0} \right)^2} \right]$$

For overcoupled circuits

$$\text{Location of peaks: } \left(\frac{\Delta f}{f_0}\right)_{peak} = \pm \frac{\sqrt{B}}{2Q} = \pm \frac{1}{2} \sqrt{k^2 - \frac{1}{2} \left(\frac{1}{Q_1^2} + \frac{1}{Q_2^2} \right)}$$

$$\text{Amplitude of peaks: } \left(\frac{E}{E_0}\right)_{peak} = \left[\frac{p+1}{\sqrt{(p+1)^2 - B^2}} \right]^m$$

Case 3: Peaks just converged to a single peak

$$\text{Here } B = 0 \quad \text{or} \quad k^2 = \frac{1}{2} \left(\frac{1}{Q_1^2} + \frac{1}{Q_2^2} \right)$$

$$\frac{E}{E_0} = \left[\frac{2}{\sqrt{\left(2Q' \frac{\Delta f}{f_0} \right)^4 + 4}} \right]^m ; \quad \frac{\Delta f}{f_0} = \pm \frac{\sqrt{2}}{4} \left(\frac{1}{Q_1} + \frac{1}{Q_2} \right) \sqrt[4]{\left(\frac{E_0}{E} \right)^{\frac{2}{m}} - 1}$$

$$\phi = m \tan^{-1} \left[- \frac{4Q' \frac{\Delta f}{f_0}}{2 - \left(2Q' \frac{\Delta f}{f_0} \right)^2} \right]$$

The curves of Figs. 6 and 7 may be applied to this case, using the value $p = 1$, and substituting Q' for Q .

Electrical circuit formulas *continued***15. T — π or Y — Δ transformation**

The two networks are equivalent, as far as conditions at the terminals are concerned, provided the following equations are satisfied. Either the impedance equations or the admittance equations may be used.

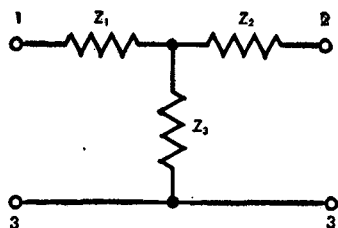
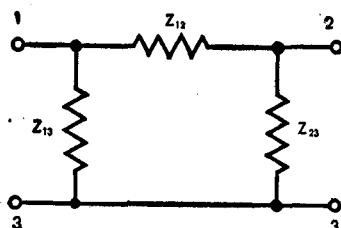
**T or Y network** **π or Δ network****Impedance equations**

$$Z_{12} = \frac{Z_1 Z_2 + Z_1 Z_3 + Z_2 Z_3}{Z_3}$$

$$Z_{13} = \frac{Z_1 Z_2 + Z_1 Z_3 + Z_2 Z_3}{Z_2}$$

$$Z_{23} = \frac{Z_1 Z_2 + Z_1 Z_3 + Z_2 Z_3}{Z_1}$$

$$Z_1 = \frac{Z_{12} Z_{13}}{Z_{12} + Z_{13} + Z_{23}}$$

$$Z_2 = \frac{Z_{12} Z_{23}}{Z_{12} + Z_{13} + Z_{23}}$$

$$Z_3 = \frac{Z_{13} Z_{23}}{Z_{12} + Z_{13} + Z_{23}}$$

Admittance equations

$$Y_{12} = \frac{Y_1 Y_2}{Y_1 + Y_2 + Y_3}$$

$$Y_{13} = \frac{Y_1 Y_3}{Y_1 + Y_2 + Y_3}$$

$$Y_{23} = \frac{Y_2 Y_3}{Y_1 + Y_2 + Y_3}$$

$$Y_1 = \frac{Y_{12} Y_{13} + Y_{12} Y_{23} + Y_{13} Y_{23}}{Y_{23}}$$

$$Y_2 = \frac{Y_{12} Y_{13} + Y_{12} Y_{23} + Y_{13} Y_{23}}{Y_{13}}$$

$$Y_3 = \frac{Y_{12} Y_{13} + Y_{12} Y_{23} + Y_{13} Y_{23}}{Y_{12}}$$

16. Amplitude modulation

In design work, usually the entire modulation is assumed to be in M_1 . Then M_2 , M_3 , etc, would be neglected in the formulas below.

When the expression $(1 + M_1 + M_2 + \dots)$ is used, it is assumed that ω_1 , ω_2 , etc, are incommensurate.

$$i = I[1 + M_1 \cos(\omega_1 t + \phi_1) + M_2 \cos(\omega_2 t + \phi_2) + \dots] \sin(\omega_0 t + \phi_0)$$

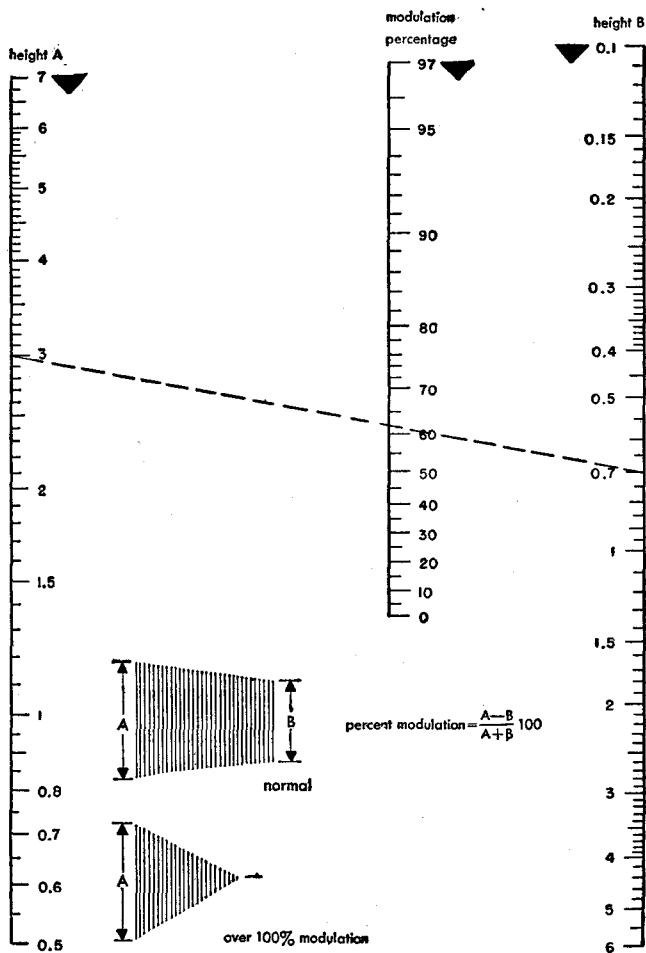
Electrical circuit formulas continued

To determine the modulation percentage from an oscillogram of type illustrated apply measurements A and B to scales A and B and read percentage from center scale. Example: A = 3 inches, B = 0.7 inches—Modulation 62%. Any units of measurement may be used.

Fig. 8—Modulation percentage from oscillograms.

Electrical circuit formulas *continued*

$$= I \left\{ \sin (\omega_0 t + \phi_0) + \frac{M_1}{2} [\sin (\omega_0 + \omega_1 t + \phi_0 + \phi_1) + \sin (\omega_0 - \omega_1 t + \phi_0 - \phi_1)] + \frac{M_2}{2} [\sin (\omega_0 + \omega_2 t + \phi_0 + \phi_2) + \sin (\omega_0 - \omega_2 t + \phi_0 - \phi_2)] + \dots \right\}$$

$$\text{Percent modulation} = (M_1 + M_2 + \dots) \times 100$$

$$= \frac{\text{crest ampl} - \text{trough ampl}}{\text{crest ampl} + \text{trough ampl}} \times 100.$$

Percent modulation may be measured by means of an oscilloscope, the modulated carrier wave being applied to the vertical plates and the modulating voltage wave to the horizontal plates. The resulting trapezoidal pattern and a nomograph for computing percent modulation are shown in Fig. 8. The dimensions A and B in that figure are proportional to the crest amplitude and trough amplitude, respectively.

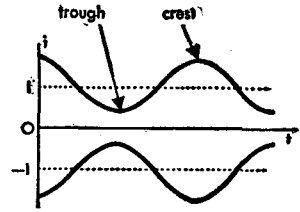

$$\text{Peak voltage at crest: } V_{\text{crest}} = V_{\text{carrier, rms}} (1 + M_1 + M_2 + \dots) \sqrt{2}$$

$$\text{Kilovolt-amperes at crest: } kva_{\text{crest}} = kva_{\text{carrier}} (1 + M_1 + M_2 + \dots)^2$$

Average kilovolt-amperes over a number of cycles of lowest modulation frequency:

$$kva_{\text{average}} = kva_{\text{carrier}} \left(1 + \frac{M_1^2}{2} + \frac{M_2^2}{2} + \dots \right)$$

Effective current of the modulated wave:

$$I_{\text{eff}} = I_{\text{carrier, rms}} \sqrt{1 + \frac{M_1^2}{2} + \frac{M_2^2}{2} + \dots}$$

17. Elementary R-C, R-L, and L-C filters

Simple attenuating sections of broad frequency discriminating characteristics, as used in power supplies, grid-bias feed, etc. The output load impedance is assumed to be high compared to the impedance of the shunt element of the filter.

Electrical circuit formulas *continued*

diagram	type	time constant or resonant freq	formula and approximation
	low-pass R - C	$T = RC$	$\frac{E_{out}}{E_{in}} = \frac{1}{\sqrt{1 + \omega^2 T^2}} \approx \frac{1}{\omega T}$
	high-pass R - C	$T = RC$	$\frac{E_{out}}{E_{in}} = \frac{1}{\sqrt{1 + \frac{1}{\omega^2 T^2}}} \approx \omega T$
	low-pass R - L	$T = \frac{L}{R}$	$\frac{E_{out}}{E_{in}} = \frac{1}{\sqrt{1 + \omega^2 T^2}} \approx \frac{1}{\omega T}$
	high-pass R - L	$T = \frac{L}{R}$	$\frac{E_{out}}{E_{in}} = \frac{1}{\sqrt{1 + \frac{1}{\omega^2 T^2}}} \approx \omega T$
	low-pass L - C	$f_0 = \frac{0.1592}{\sqrt{LC}}$	$\frac{E_{out}}{E_{in}} = \frac{1}{\omega^2 LC - 1} = \frac{1}{\frac{f^2}{f_0^2} - 1} \approx \frac{1}{\omega^2 LC} = \frac{f_0^2}{f^2}$
	high-pass L - C	$f_0 = \frac{0.1592}{\sqrt{LC}}$	$\frac{E_{out}}{E_{in}} = \frac{1}{\frac{1}{\omega^2 LC} - 1} = \frac{1}{\frac{1}{f^2} - 1} \approx \omega^2 LC = \frac{f^2}{f_0^2}$

R in ohms L in henries C in farads (1 μ f = 10^{-6} farad)

T = time constant (seconds) f_0 = resonant frequency (cps) $\omega = 2\pi f$

$2\pi = 6.28$ $\frac{1}{2\pi} = 0.1592$ $4\pi^2 = 39.5$ $\frac{1}{4\pi^2} = 0.0253$

Electrical circuit formulas *continued*

The relationships for low-pass filters are plotted in Figs. 9 and 10.

Examples**1. Low-pass R-C filters**

a. $R = 100,000$ ohms, $C = 0.1 \times 10^{-6}$ (0.1 μ f)

Then $T = RC = 0.01$ second

At $f = 100$ cps, $\frac{E_{out}}{E_{in}} = 0.16$

At $f = 30,000$ cps, $\frac{E_{out}}{E_{in}} = 0.00053$

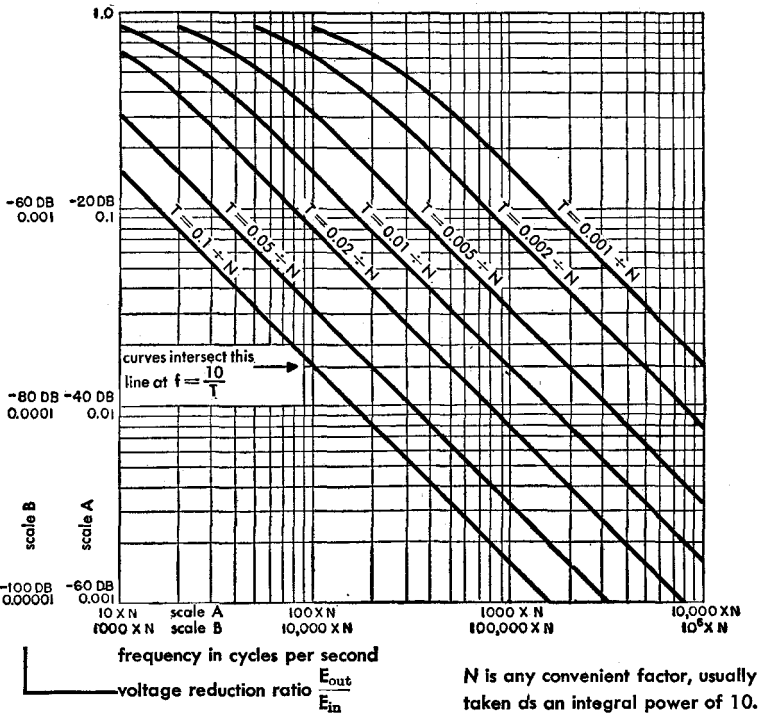

Fig. 9—Low-pass R-C and R-L filters.

Electrical circuit formulas *continued***18. Transients**

The complete transient in a linear network is, by the principle of superposition, the sum of the individual transients due to the store of energy in each inductor and capacitor and to each external source of energy connected to the network. To this is added the steady state condition due to each external source of energy. The transient may be computed as starting from any arbitrary time $t = 0$ when the initial conditions of the energy of the network are known.

Convention of signs: In the following formulas, one direction of current is assumed to be positive, and any emf on a capacitor or in an external source, tending to produce a current in the positive direction, is designated as positive. In the case of the charge of a capacitor, this results in the capacitor voltage being the negative of the value sometimes conventionally used, wherein the junction of the source and the capacitor is assumed to be grounded and potentials are computed with respect to ground.

Time constant (designated T): of the discharge of a capacitor through a resistor is the time $t_2 - t_1$ required for the voltage or current to decay to $\frac{1}{e}$ of its value at time t_1 . For the charge of a capacitor the same definition applies, the voltage "decaying" toward its steady state value. The time constant of discharge or charge of the current in an inductor through a resistor follows an analogous definition.

Energy stored in a capacitor = $\frac{1}{2} CE^2$ joules (watt-seconds).

Energy stored in an inductor = $\frac{1}{2} LI^2$ joules (watt-seconds).

$$\epsilon = 2.718 \quad \frac{1}{e} = 0.3679 \quad \log_{10} \epsilon = 0.4343 \quad T \text{ and } t \text{ in seconds}$$

R in ohms L in henries C in farads E in volts I in amperes

Capacitor charge and discharge

Closing of switch occurs at time $t = 0$

Initial conditions (at $t = 0$): Battery = E_b ; $e_c = E_0$.

Steady state (at $t = \infty$): $i = 0$; $e_c = -E_b$.

Transient:

$$i = \frac{E_b + E_0}{R} e^{-\frac{t}{RC}} = I_0 e^{-\frac{t}{RC}}$$

$$\log_{10} \left(\frac{i}{I_0} \right) = -\frac{0.4343}{RC} t$$

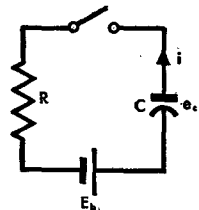

Electrical circuit formulas *continued*

$$e_c = E_0 - \frac{1}{C} \int_0^t i dt = E_0 \epsilon^{-\frac{t}{RC}} - E_b \left(1 - \epsilon^{-\frac{t}{RC}} \right)$$

Time constant: $T = RC$

Fig. 11 shows current $\frac{i}{I_0} = \epsilon^{-\frac{t}{T}}$

Fig. 11 shows discharge (for $E_b = 0$) $\frac{e_c}{E_0} = \epsilon^{-\frac{t}{T}}$

Fig. 12 shows charge (for $E_0 = 0$) $-\frac{e_c}{E_b} = \left(1 - \epsilon^{-\frac{t}{T}} \right)$

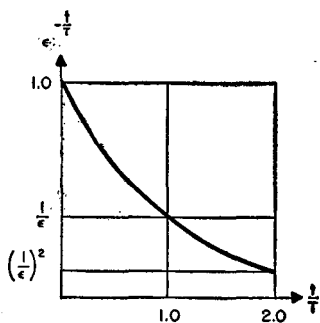

Fig. 11.

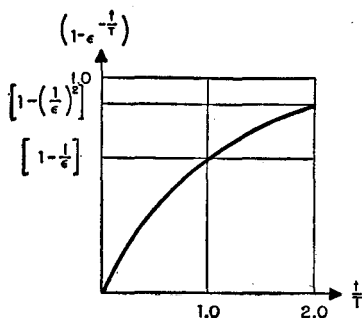

Fig. 12.

These curves are plotted on a larger scale in Fig. 13.

Two capacitors

Closing of switch occurs at time $t = 0$

Initial conditions (at $t = 0$):

$$e_1 = E_1; e_2 = E_2.$$

Steady state (at $t = \infty$):

$$e_1 = E_f; e_2 = -E_f; i = 0.$$

$$E_f = \frac{E_1 C_1 - E_2 C_2}{C_1 + C_2} \quad C' = \frac{C_1 C_2}{C_1 + C_2}$$

Transient:

$$i = \frac{E_1 + E_2}{R} \epsilon^{-\frac{t}{RC'}}$$

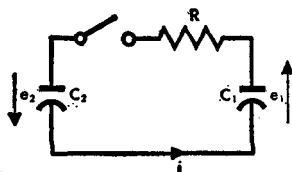

Electrical circuit formulas continued

$$e_1 = E_f + (E_1 - E_f) e^{-\frac{t}{RC'}} = E_1 - (E_1 + E_2) \frac{C'}{C_1} \left(1 - e^{-\frac{t}{RC'}}\right)$$

$$e_2 = -E_f + (E_2 + E_f) e^{-\frac{t}{RC'}} = E_2 - (E_1 + E_2) \frac{C'}{C_2} \left(1 - e^{-\frac{t}{RC'}}\right)$$

Original energy = $\frac{1}{2} (C_1 E_1^2 + C_2 E_2^2)$ joules

Final energy = $\frac{1}{2} (C_1 + C_2) E_f^2$ joules

$$\text{Loss of energy} = \int_0^{\infty} i^2 R dt = \frac{1}{2} C' (E_1 + E_2)^2 \text{ joules}$$

(Loss is independent of the value of R.)

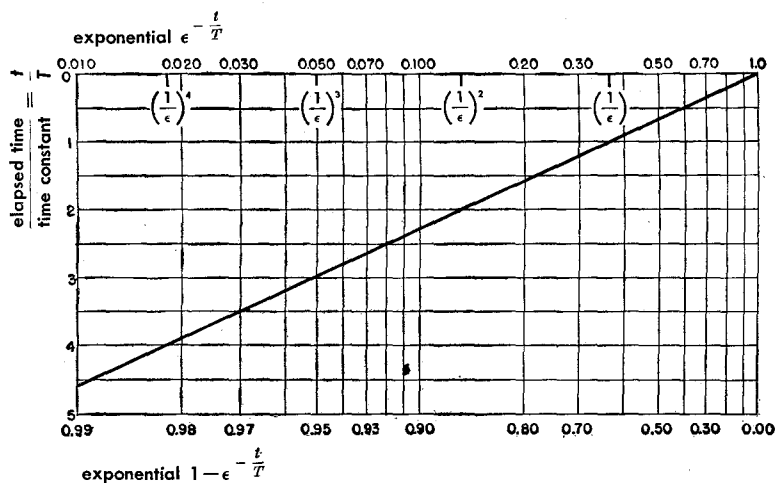

Use exponential $e^{-\frac{t}{T}}$ for charge or discharge of capacitor or discharge of inductor:

$$\frac{\text{current at time } t}{\text{initial current}}$$

discharge of capacitor:

$$\frac{\text{voltage at time } t}{\text{initial voltage}}$$

Use exponential $1 - e^{-\frac{t}{T}}$ for charge of capacitor:

$$\frac{\text{voltage at time } t}{\text{battery or final voltage}}$$

charge of inductor:

$$\frac{\text{current at time } t}{\text{final current}}$$

Fig. 13—Exponential functions $e^{-\frac{t}{T}}$ and $1 - e^{-\frac{t}{T}}$ applied to transients in R-C and L-R circuits.

Electrical circuit formulas *continued*

Inductor charge and discharge

Initial conditions (at $t = 0$):

Battery = E_b ; $i = I_0$

Steady state (at $t = \infty$): $i = I_f = \frac{E_b}{R}$

Transient:

$$i = I_f \left(1 - e^{-\frac{Rt}{L}} \right) + I_0 e^{-\frac{Rt}{L}}$$

$$e_L = -L \frac{di}{dt} = -(E_b - RI_0) e^{-\frac{Rt}{L}}$$

Time constant: $T = \frac{L}{R}$

Fig. 11 shows discharge (for $E_b = 0$) $\frac{i}{I_0} = e^{-\frac{t}{T}}$

Fig. 12 shows charge (for $I_0 = 0$) $\frac{i}{I_f} = \left(1 - e^{-\frac{t}{T}} \right)$

These curves are plotted on a larger scale in Fig. 13.

Series circuit of R, L, and C charge and discharge

Initial conditions (at $t = 0$):

Battery = E_b ; $e_c = E_0$; $i = I_0$

Steady state (at $t = \infty$): $i = 0$; $e_c = -E_b$

Differential equation:

$$E_b + E_0 - \frac{1}{C} \int_0^t i dt - Ri - L \frac{di}{dt} = 0$$

whence $L \frac{d^2i}{dt^2} + R \frac{di}{dt} + \frac{i}{C} = 0$

Solution of equation:

$$i = e^{-\frac{Rt}{2L}} \left[\frac{2(E_b + E_0) - RI_0}{R\sqrt{D}} \sinh \frac{Rt}{2L} \sqrt{D} + I_0 \cosh \frac{Rt}{2L} \sqrt{D} \right]$$

where $D = 1 - \frac{4L}{R^2C}$

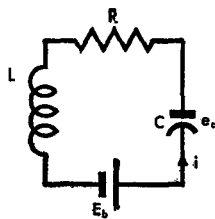
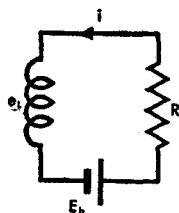

Electrical circuit formulas *continued*

Case 1: When $\frac{L}{R^2C}$ is small

$$i = \frac{1}{(1 - 2A - 2A^2)} \left\{ \left[\frac{E_b + E_0}{R} - I_0 (A + A^2) \right] e^{-\frac{t}{RC} (1 + A + 2A^2)} + \left[I_0 (1 - A - A^2) - \frac{E_b + E_0}{R} \right] e^{-\frac{Rt}{L} (1 - A - A^2)} \right\}$$

where $A = \frac{L}{R^2C}$

For practical purposes, the terms A^2 can be neglected when $A < 0.1$. The terms A may be neglected when $A < 0.01$.

Case 2: When $\frac{4L}{R^2C} < 1$ for which \sqrt{D} is real

$$i = \frac{e^{-\frac{Rt}{2L}}}{\sqrt{D}} \left\{ \left[\frac{E_b + E_0}{R} - \frac{I_0}{2} (1 - \sqrt{D}) \right] e^{\frac{Rt}{2L} \sqrt{D}} + \left[\frac{I_0}{2} (1 + \sqrt{D}) - \frac{E_b + E_0}{R} \right] e^{-\frac{Rt}{2L} \sqrt{D}} \right\}$$

Case 3: When D is a small positive or negative quantity

$$i = e^{-\frac{Rt}{2L}} \left\{ \frac{2(E_b + E_0)}{R} \left[\frac{Rt}{2L} + \frac{1}{6} \left(\frac{Rt}{2L} \right)^3 D \right] + I_0 \left[1 - \frac{Rt}{2L} + \frac{1}{2} \left(\frac{Rt}{2L} \right)^2 D - \frac{1}{6} \left(\frac{Rt}{2L} \right)^3 D \right] \right\}$$

This formula may be used for values of D up to ± 0.25 , at which values the error in the computed current i is approximately 1 percent of I_0 or of $\frac{E_b + E_0}{R}$.

Case 3a: When $\frac{4L}{R^2C} = 1$ for which $D = 0$, the formula reduces to

$$i = e^{-\frac{Rt}{2L}} \left[\frac{E_b + E_0}{R} \frac{Rt}{L} + I_0 \left(1 - \frac{Rt}{2L} \right) \right]$$

or $i = i_1 + i_2$, plotted in Fig. 14. For practical purposes, this formula may be

used when $\frac{4L}{R^2C} = 1 \pm 0.05$ with errors of 1 percent or less.

Electrical circuit formulas *continued*

Case 4: When $\frac{4L}{R^2C} > 1$ for which \sqrt{D} is imaginary

$$i = e^{-\frac{Rt}{2L}} \left\{ \left[\frac{E_b + E_0}{\omega_0 L} - \frac{RI_0}{2\omega_0 L} \right] \sin \omega_0 t + I_0 \cos \omega_0 t \right\}$$

$$= I_m e^{-\frac{Rt}{2L}} \sin(\omega_0 t + \psi)$$

where $\omega_0 = \sqrt{\frac{1}{LC} - \frac{R^2}{4L^2}}$

$$I_m = \frac{1}{\omega_0 L} \sqrt{\left(E_b + E_0 - \frac{RI_0}{2} \right)^2 + \omega_0^2 L^2 I_0^2}$$

$$\psi = \tan^{-1} \frac{\omega_0 L I_0}{E_b + E_0 - \frac{RI_0}{2}}$$

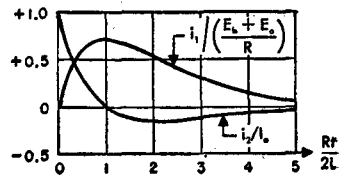

Fig. 14—Transients for $\frac{4L}{R^2C} = 1$.

The envelope of the voltage wave across the inductor is:

$$\pm e^{-\frac{Rt}{2L}} \frac{1}{\omega_0 \sqrt{LC}} \sqrt{\left(E_b + E_0 - \frac{RI_0}{2} \right)^2 + \omega_0^2 L^2 I_0^2}$$

Example: Relay with transient suppressing capacitor.

Switch closed till time $t = 0$, then opened.

Let $L = 0.10$ henries, $R_1 = 100$ ohms,

$E = 10$ volts

Suppose we choose $C = 10^{-6}$ farads, $R_2 = 100$ ohms.

Then $R = 200$ ohms, $I_0 = 0.10$ amperes,

$E_0 = 10$ volts, $\omega_0 = 3 \times 10^3$, $f_0 = 480$ cps

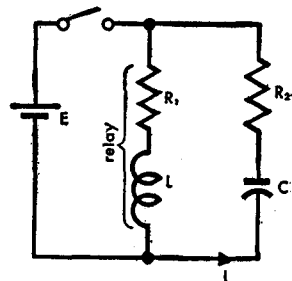

Maximum peak voltage across L (envelope at $t = 0$) is approximately 30 volts. Time constant of decay of envelope is 0.001 second.

If it had been desired to make the circuit just non-oscillating, (Case 3a):

$$\frac{4L}{R^2C} = 1 \text{ or } R = 630 \text{ ohms for } C = 10^{-6} \text{ farads.}$$

$R_2 = 530$ ohms.

Initial voltage at $t = 0$, across L is $-E_0 + RI_0 = 53$ volts.

Electrical circuit formulas *continued***Series circuit of R, L, and C with sinusoidal applied voltage**

By the principle of superposition, the transient and steady state conditions are the same for the actual circuit and the equivalent circuit shown in the accompanying illustrations, the closing of the switch occurring at time $t = 0$. In the equivalent circuit, the steady state is due to the source e acting continuously from time $t = -\infty$, while the transient is due to short circuiting the source $-e$ at time $t = 0$.

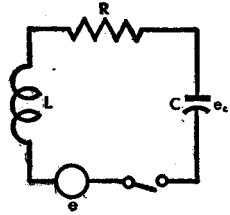
**actual circuit**

Source: $e = E \sin(\omega t + \alpha)$

Steady state: $i = \frac{e}{Z} \angle -\phi = \frac{E}{Z} \sin(\omega t + \alpha - \phi)$

where

$$Z = \sqrt{R^2 + \left(\omega L - \frac{1}{\omega C}\right)^2}; \quad \tan \phi = \frac{\omega^2 LC - 1}{\omega CR}$$

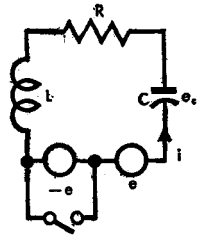
**equivalent circuit**

The transient is found by determining current $i = I_0$ and capacitor voltage $e_c = E_0$ at time $t = 0$, due to the source $-e$. These values of I_0 and E_0 are then substituted in the equations of Case 1, 2, 3, or 4, above, according to the values of R , L , and C .

At time $t = 0$, due to the source $-e$:

$$i = I_0 = -\frac{E}{Z} \sin(\alpha - \phi)$$

$$e_c = E_0 = \frac{-E}{\omega CZ} \cos(\alpha - \phi)$$

This form of analysis may be used for any periodic applied voltage e . The steady-state current and the capacitor voltage for an applied voltage $-e$ are determined, the periodic voltage being resolved into its harmonic components for this purpose, if necessary. Then the instantaneous values $i = I_0$ and $e_c = E_0$ at the time of closing the switch are easily found, from which the transient is determined. It is evident, from this method of analysis, that the wave form of the transient need bear no relationship to that of the applied voltage, depending only on the constants of the circuit and the hypothetical initial conditions I_0 and E_0 .

Electrical circuit formulas *continued*

19. Effective and average values of alternating current

(Similar equations apply to a-c voltages)

$$i = I \sin \omega t$$

$$\text{Average value } I_{av} = \frac{2}{\pi} I$$

which is the direct current which would be obtained were the original current fully rectified, or approximately proportional to the reading of a rectifier-type meter.

$$\text{Effective or root-mean-square (rms) value } I_{eff} = \frac{I}{\sqrt{2}}$$

which represents the heating or power effectiveness of the current, and is proportional to the reading of a dynamometer or thermal-type meter.

When

$$i = I_0 + I_1 \sin \omega_1 t + I_2 \sin \omega_2 t + \dots$$

$$I_{eff} = \sqrt{I_0^2 + \frac{1}{2} (I_1^2 + I_2^2 + \dots)}$$

Note: The average value of a complex current is *not* equal to the sum of the average values of the components.

20. Constants of long transmission lines

$$\alpha = \sqrt{\frac{1}{2} \{ \sqrt{(R^2 + \omega^2 L^2) (G^2 + \omega^2 C^2)} + GR - \omega^2 LC \}}$$

$$\beta = \sqrt{\frac{1}{2} \{ \sqrt{(R^2 + \omega^2 L^2) (G^2 + \omega^2 C^2)} - GR + \omega^2 LC \}}$$

where

- | | | |
|---|---|--------------------------|
| <ul style="list-style-type: none"> α = attenuation constant in nepers β = phase constant in radians R = resistance constant in ohms G = conductance constant in mhos L = inductance constant in henries C = capacitance constant in farads $\omega = 2\pi \times$ frequency in cycles per second | } | per unit length of line. |
|---|---|--------------------------|

Using values per mile for $R, G, L,$ and $C,$ the db loss per mile will be 8.686α and the wavelength in miles will be $\frac{2\pi}{\beta}.$

Electrical circuit formulas *continued*

If vector formulas are preferred, α and β may be determined from the following:

$$\alpha + j\beta = \sqrt{ZY} = \sqrt{(R + j\omega L)(G + j\omega C)}$$

where all constants have the same meaning as above.

Characteristic impedance

$$Z_0 = \sqrt{\frac{Z}{Y}} = \sqrt{\frac{R + j\omega L}{G + j\omega C}}$$

Note: For radio frequency applications, see formulas under R-F Transmission Line Data.

Attenuators

An attenuator is a network designed to introduce a known loss when working between resistive impedances Z_1 and Z_2 to which the input and output impedances of the attenuator are matched. Either Z_1 or Z_2 may be the source and the other the load. The attenuation of such networks expressed as a power ratio is the same regardless of the direction of working.

Three forms of resistance network which may be conveniently used to realize these conditions are shown on page 106. These are the T section, the π section, and the Bridged-T section. Equivalent balanced sections also are shown. Methods are given for the computation of attenuator networks, the hyperbolic expressions giving rapid solutions with the aid of tables of hyperbolic functions on pages 313 to 315. Tables of the various types of attenuators are given on pages 108 to 114.

In the formulas

Z_1 and Z_2 are the terminal impedances (resistive) to which the attenuator is matched.

N is the ratio of the power absorbed by the attenuator from the source to the power delivered to the load.

K is the ratio of the attenuator input current to the output current into the load. When $Z_1 = Z_2$, $K = \sqrt{N}$.

Attenuation in decibels = $10 \log_{10} N$

Attenuation in nepers = $\theta = \frac{1}{2} \log_e N$

For a table of decibels versus power and voltage or current ratio, see page 34. Factors for converting decibels to nepers, and nepers to decibels, are given at the foot of that table.

Attenuators *continued*

General remarks

The formulas and figures for errors, given in Tables IV to VIII, are based on the assumption that the attenuator is terminated approximately by its proper terminal impedances Z_1 and Z_2 . They hold for deviations of the attenuator arms and load impedances up to ± 20 percent or somewhat more. The error due to each element is proportional to the deviation of the element, and the total error of the attenuator is the sum of the errors due to each of the several elements.

When any element or arm R has a reactive component ΔX in addition to a resistive error ΔR , the errors in input impedance and output current are

$$\Delta Z = A(\Delta R + j\Delta X)$$

$$\frac{\Delta i}{i} = B \left(\frac{\Delta R + j\Delta X}{R} \right)$$

where A and B are constants of proportionality for the elements in question. These constants can be determined in each case from the figures given for errors due to a resistive deviation ΔR .

The reactive component ΔX produces a quadrature component in the output current, resulting in a phase shift. However, for small values of ΔX , the error in insertion loss is negligibly small.

For the errors produced by mismatched terminal load impedance, refer to Case 1, page 105.

Ladder attenuator

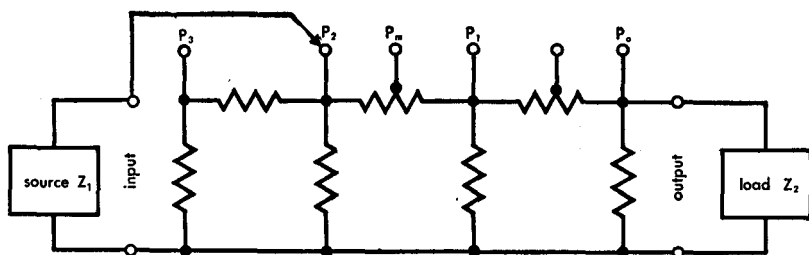

Fig. 15—Ladder attenuator.

Ladder attenuator, Fig. 15, input switch points P_0 , P_1 , P_2 , P_3 at shunt arms. Also intermediate point P_m tapped on series arm. May be either unbalanced, as shown, or balanced.

Attenuators *continued*

Ladder, for design purposes, Fig. 16, is resolved into a cascade of π sections by imagining each shunt arm split into two resistors. Last section matches Z_2 to $2Z_1$. All other sections are symmetrical, matching impedances $2Z_1$, with a

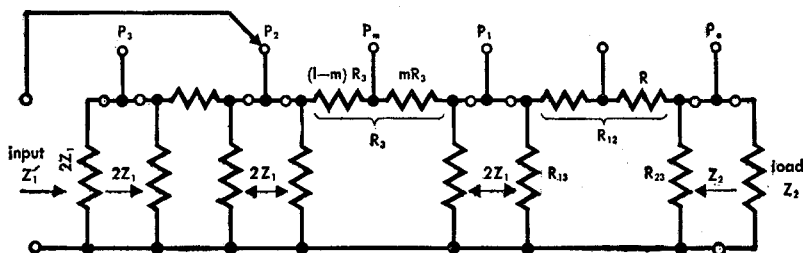

Fig. 16—Ladder attenuator resolved into a cascade of π sections.

terminating resistor $2Z_1$ on the first section. Each section is designed for the loss required between the switch points at the ends of that section.

$$\text{Input to } P_0: \text{ Loss, db} = 10 \log_{10} \frac{(2Z_1 + Z_2)^2}{4Z_1Z_2}$$

$$\text{Input impedance } Z_1' = \frac{Z_2}{2}$$

$$\text{Output impedance} = \frac{Z_1Z_2}{Z_1 + Z_2}$$

Input to P_1 , P_2 , or P_3 : Loss, db = 3 db + sum of losses of π sections between input and output. Input impedance $Z_1' = Z_1$

Input to P_m (on a symmetrical π section):

$$\frac{e_0}{e_m} = \frac{1}{2} \frac{m(1-m)(K-1)^2 + 2K}{K-m(K-1)}$$

where

e_0 = output voltage when $m = .0$ (Switch on P_1).

e_m = output voltage with switch on P_m .

and

K = current ratio of the section (from P_1 to P_2). $K > 1$.

$$\text{Input impedance } Z_1' = Z_1 \left[m(1-m) \frac{(K-1)^2}{K} + 1 \right]$$

$$\text{Max } Z_1' = Z_1 \left[\frac{(K-1)^2}{4K} + 1 \right] \text{ for } m = 0.5.$$

Attenuators *continued*

The unsymmetrical last section may be treated as a system of voltage dividing resistors. Solve for the resistance R from P_0 to the tap, for each value of

- output voltage with input on P_0
- output voltage with input on tap

A useful case: $Z_1 = Z_2 = 500$ ohms.

Then loss on P_0 is 3.52 db.

Let the last section be designed for loss of 12.51 db.

Then

$R_{13} = 2444$ ohms (shunted by 1000 ohms)

$R_{23} = 654$ ohms (shunted by 500 ohms)

$R_{12} = 1409$ ohms.

The table shows the location of the tap and the input and output impedances for several values of loss, relative to the loss on P_0 .

relative loss db	tap R ohms	input impedance ohms	output impedance ohms
0	0	250	250
2	170	368	304
4	375	478	353
6	615	562	394
8	882	600	428
10	1157	577	454
12	1409	500	473

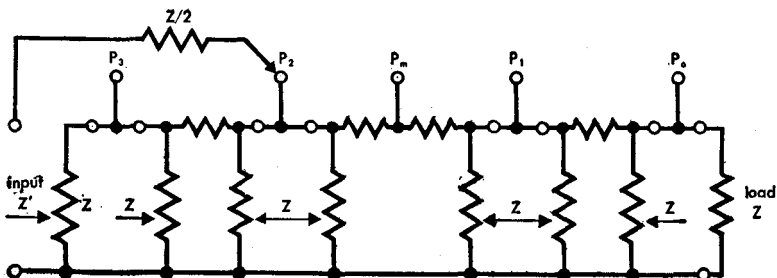

Fig. 17—A variation of the ladder attenuator, useful when $Z_1 = Z_2 = Z$. Simpler in design, with improved impedance characteristics, but having minimum insertion loss 2.5 db higher than attenuator of Fig. 16. All π sections are symmetrical.

Attenuators *continued*

Input to P_0 : Output impedance = $0.6 Z$ (See Fig. 17.)

Input to $P_0, P_1, P_2,$ or P_3 : Loss = 6 db + sum of losses of π sections between input and output. Input impedance = Z

$$\text{Input to } P_m: \frac{e_0}{e_m} = \frac{1}{4} \frac{m(1-m)(K-1)^2 + 4K}{K-m(K-1)}$$

$$\text{Input impedance } Z' = Z \left[\frac{m(1-m)(K-1)^2}{2K} + 1 \right]$$

$$\text{Max } Z' = Z \left[\frac{(K-1)^2}{8K} + 1 \right] \text{ for } m = 0.5.$$

Effect of incorrect load impedance on operation of an attenuator

In the applications of attenuators the question frequently arises as to the effect upon the input impedance and the attenuation by the use of a load impedance which is different from that for which the network was designed. The following results apply to all resistive networks which, when operated between resistive impedances Z_1 and Z_2 , present matching terminal impedances Z_1 and Z_2 , respectively. The results may be derived in the general case by the application of the network theorems, and may be readily confirmed mathematically for simple specific cases such as the T section.

For the designed use of the network, let

Z_1 = input impedance of properly terminated network

Z_2 = load impedance which properly terminates the network

N = power ratio from input to output

K = current ratio from input to output

$$K = \frac{i_1}{i_2} = \sqrt{\frac{NZ_2}{Z_1}} \text{ (different in the two directions of operation except when } Z_2 = Z_1 \text{).}$$

For the actual conditions of operation, let

$$(Z_2 + \Delta Z_2) = Z_2 \left(1 + \frac{\Delta Z_2}{Z_2} \right) = \text{actual load impedance}$$

$$(Z_1 + \Delta Z_1) = Z_1 \left(1 + \frac{\Delta Z_1}{Z_1} \right) = \text{resulting input impedance}$$

$$(K + \Delta K) = K \left(1 + \frac{\Delta K}{K} \right) = \text{resulting current ratio.}$$

Attenuators *continued*

While Z_1 , Z_2 , and K are restricted to real quantities by the assumed nature of the network, ΔZ_2 is not so restricted, e.g.,

$$\Delta Z_2 = \Delta R_2 + j\Delta X_2$$

As a consequence ΔZ_1 and ΔK can become imaginary or complex. Furthermore ΔZ_2 is not restricted to small values.

The results for the actual conditions are

$$\frac{\Delta Z_1}{Z_1} = \frac{2 \frac{\Delta Z_2}{Z_2}}{2N + (N-1) \frac{\Delta Z_2}{Z_2}} \quad \text{and} \quad \frac{\Delta K}{K} = \left(\frac{N-1}{2N} \right) \frac{\Delta Z_2}{Z_2}$$

Certain special cases may be cited

Case 1: For small $\frac{\Delta Z_2}{Z_2}$

$$\frac{\Delta Z_1}{Z_1} = \frac{1}{N} \frac{\Delta Z_2}{Z_2} \quad \text{or} \quad \Delta Z_1 = \frac{1}{K^2} \Delta Z_2 \quad \frac{\Delta i_2}{i_2} = -\frac{1}{2} \frac{\Delta Z_2}{Z_2}$$

but the error in insertion power loss of the attenuator is negligibly small.

Case 2: Short-circuited output $\frac{\Delta Z_1}{Z_1} = \frac{-2}{N+1}$

$$\text{or input impedance} = \left(\frac{N-1}{N+1} \right) Z_1 = Z_1 \tanh \theta$$

where θ is the designed attenuation in nepers.

Case 3: Open-circuited output $\frac{\Delta Z_1}{Z_1} = \frac{2}{N-1}$

$$\text{or input impedance} = \left(\frac{N+1}{N-1} \right) Z_1 = Z_1 \coth \theta$$

Case 4: For $N = 1$ (possible only when $Z_1 = Z_2$ and directly connected)

$$\frac{\Delta Z_1}{Z_1} = \frac{\Delta Z_2}{Z_2} \quad \text{and} \quad \frac{\Delta K}{K} = 0$$

Case 5: For large N $\frac{\Delta K}{K} = \frac{1}{2} \frac{\Delta Z_2}{Z_2}$

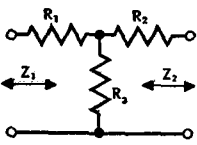
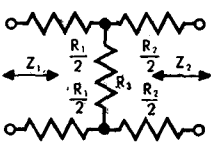
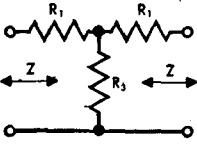
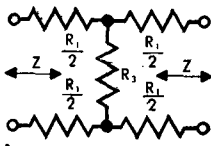
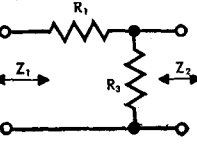
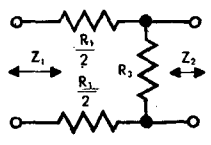
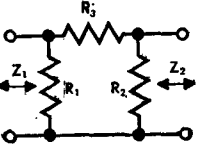
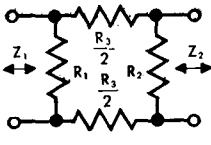
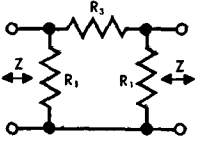
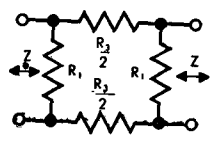
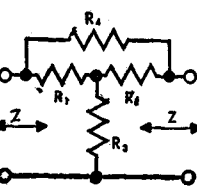
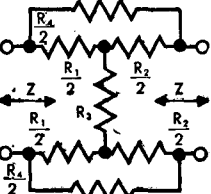
description	configuration	
	unbalanced	balanced
Unbalanced T and balanced H see Table VIII		
Symmetrical T and H ($Z_1 = Z_2 = Z$) see Table IV		
Minimum loss pad matching Z_1 and Z_2 ($Z_1 > Z_2$) see Table VII		
Unbalanced π and balanced O		
Symmetrical π and O ($Z_1 = Z_2 = Z$) see Table V		
Bridged T and bridged H see Table VI		

network design see page 100 for symbols

design formulas

hyperbolic	arithmetical	checking formulas
$R_3 = \frac{\sqrt{Z_1 Z_2}}{\sinh \theta}$ $R_1 = \frac{Z_1}{\tanh \theta} - R_3$ $R_2 = \frac{Z_2}{\tanh \theta} - R_3$	$R_3 = \frac{2\sqrt{NZ_1 Z_2}}{N-1}$ $R_1 = Z_1 \left(\frac{N+1}{N-1} \right) - R_3$ $R_2 = Z_2 \left(\frac{N+1}{N-1} \right) - R_3$	
$R_3 = \frac{Z}{\sinh \theta}$ $R_1 = Z \tanh \frac{\theta}{2}$	$R_3 = \frac{2Z\sqrt{N}}{N-1} = \frac{2ZK}{K^2-1}$ $R_1 = Z \frac{\sqrt{N-1}}{\sqrt{N+1}} = Z \frac{K-1}{K+1}$	$R_1 R_3 = \frac{Z^2}{1 + \cosh \theta} = Z^2 \frac{2K}{(K+1)^2}$ $\frac{R_1}{R_3} = \cosh \theta - 1 = 2 \sinh^2 \frac{\theta}{2}$ $= \frac{(K-1)^2}{2K}$ $Z = R_1 \sqrt{1 + 2 \frac{R_3}{R_1}}$
$\cosh \theta = \sqrt{\frac{Z_1}{Z_2}}$ $\cosh 2\theta = 2 \frac{Z_1}{Z_2} - 1$	$R_1 = Z_1 \sqrt{1 - \frac{Z_2}{Z_1}}$ $R_3 = \frac{Z_2}{\sqrt{1 - \frac{Z_2}{Z_1}}}$	$R_1 R_3 = Z_1 Z_2$ $\frac{R_1}{R_3} = \frac{Z_1}{Z_2} - 1$ $N = \left(\sqrt{\frac{Z_1}{Z_2}} + \sqrt{\frac{Z_1}{Z_2} - 1} \right)^2$
$R_3 = \sqrt{Z_1 Z_2} \sinh \theta$ $\frac{1}{R_1} = \frac{1}{Z_1 \tanh \theta} - \frac{1}{R_3}$ $\frac{1}{R_2} = \frac{1}{Z_2 \tanh \theta} - \frac{1}{R_3}$	$R_3 = \frac{N-1}{2} \sqrt{\frac{Z_1 Z_2}{N}}$ $\frac{1}{R_1} = \frac{1}{Z_1} \left(\frac{N+1}{N-1} \right) - \frac{1}{R_3}$ $\frac{1}{R_2} = \frac{1}{Z_2} \left(\frac{N+1}{N-1} \right) - \frac{1}{R_3}$	
$R_3 = Z \sinh \theta$ $R_1 = \frac{Z}{\tanh \frac{\theta}{2}}$	$R_3 = Z \frac{N-1}{2\sqrt{N}} = Z \frac{K^2-1}{2K}$ $R_1 = Z \frac{\sqrt{N+1}}{\sqrt{N-1}} = Z \frac{K+1}{K-1}$	$R_1 R_3 = Z^2 (1 + \cosh \theta) = Z^2 \frac{(K+1)^2}{2K}$ $\frac{R_3}{R_1} = \cosh \theta - 1 = \frac{(K-1)^2}{2K}$ $Z = \frac{R_1}{\sqrt{1 + 2 \frac{R_3}{R_1}}}$
	$R_1 = R_2 = Z$ $R_4 = Z(K-1)$ $R_3 = \frac{Z}{K-1}$	$R_3 R_4 = Z^2$ $\frac{R_4}{R_3} = (K-1)^2$

Four-terminal networks: The hyperbolic formulas above are valid for passive linear four-terminal networks in general, working between input and output impedances matching the respective image impedances. In this case: Z_1 and Z_2 are the image impedances; R_1 , R_2 and R_3 become complex impedances; and θ is the image transfer constant. $\theta = \alpha + j\beta$, where α is the image attenuation constant and β is the image phase constant.

Attenuators *continued***Table IV—Symmetrical T or H attenuator****Z = 500 ohms resistive (diagram page 106)**

attenuation db	series arm R_1 ohms	shunt arm R_3 ohms	$\frac{1000}{R_3}$	$\log_{10} R_3$
0.0	0.0	inf	0.0000	
0.2	5.8	21,700	0.0461	
0.4	11.5	10,850	0.0921	
0.6	17.3	7,230	0.1383	
0.8	23.0	5,420	0.1845	
1.0	28.8	4,330	0.2308	
2.0	57.3	2,152	0.465	
3.0	85.5	1,419	0.705	
4.0	113.1	1,048	0.954	
5.0	140.1	822	1.216	
6.0	166.1	669	1.494	2.826
7.0	191.2	558		2.747
8.0	215.3	473.1		2.675
9.0	238.1	405.9		2.608
10.0	259.7	351.4		2.546
12.0	299.2	268.1		2.428
14.0	333.7	207.8		2.318
16.0	363.2	162.6		2.211
18.0	388.2	127.9		2.107
20.0	409.1	101.0		2.004
22.0	426.4	79.94		1.903
24.0	440.7	63.35		1.802
26.0	452.3	50.24		1.701
28.0	461.8	39.87		1.601
30.0	469.3	31.65		1.500
35.0	482.5	17.79		1.250
40.0	490.1	10.00		1.000
50.0	496.8	3.162		0.500
60.0	499.0	1.000		0.000
80.0	499.9	0.1000		-1.000
100.0	500.0	0.01000		-2.000

Attenuators *continued*

Interpolation of symmetrical T or H attenuators

Column R_1 may be interpolated linearly. Do not interpolate R_3 column. For 0 to 6 db, interpolate the $\frac{1000}{R_3}$ column. Above 6 db, interpolate the column $\log_{10} R_3$ and determine R_3 from the result.

Errors in symmetrical T or H attenuators

Series arms R_1 and R_2 in error

Error in input impedances:

$$\Delta Z_1 = \Delta R_1 + \frac{1}{K^2} \Delta R_2$$

and

$$\Delta Z_2 = \Delta R_2 + \frac{1}{K^2} \Delta R_1$$

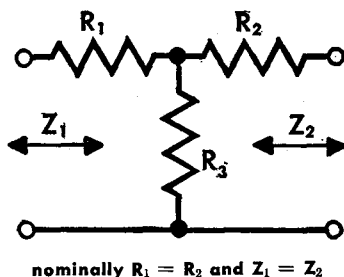

Error in insertion loss, db = $4 \left(\frac{\Delta R_1}{Z_1} + \frac{\Delta R_2}{Z_2} \right)$, approximately.

Shunt arm R_3 in error (10 percent high)

designed loss, db	error in insertion loss, db	error in input impedance $100 \frac{\Delta Z}{Z}$ percent
0.2	-0.01	0.2
1	-0.05	1.0
6	-0.3	3.3
12	-0.5	3.0
20	-0.7	1.6
40	-0.8	0.2
100	-0.8	0.0

Error in input impedance: $\frac{\Delta Z}{Z} = 2 \frac{K - 1}{K(K + 1)} \frac{\Delta R_3}{R_3}$

Error in output current: $\frac{\Delta i}{i} = \frac{K - 1}{K + 1} \frac{\Delta R_3}{R_3}$

See General Remarks on page 101.

Attenuators *continued***Table V—Symmetrical π and O attenuators**

The values of the series and shunt arms of these attenuators may be determined from Table IV of symmetrical T attenuators by means of the following formulas.

$$\text{Shunt arms: } R_{13} = R_{23} = R_1 + 2R_3 = \frac{Z^2}{R_1}$$

$$\text{Series arm: } R_{12} = R_1 \left(\frac{R_1}{R_3} + 2 \right) = \frac{Z^2}{R_3}$$

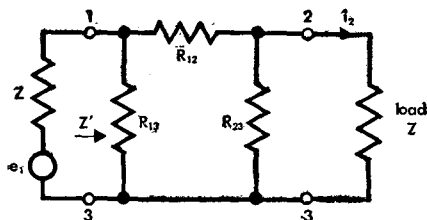

π section with source and load
 $R_{13} = R_{23}$ and $Z' = Z$

$$\text{Error in loss, db} = -8 \frac{\Delta i_2}{i_2} \text{ (approximately)}$$

$$= 4 \frac{K-1}{K+1} \left(-\frac{\Delta R_{13}}{R_{13}} - \frac{\Delta R_{23}}{R_{23}} + 2 \frac{\Delta R_{12}}{R_{12}} \right)$$

Error in input impedance:

$$\frac{\Delta Z'}{Z'} = \frac{K-1}{K+1} \left(\frac{\Delta R_{13}}{R_{13}} + \frac{1}{K^2} \frac{\Delta R_{23}}{R_{23}} + \frac{2}{K} \frac{\Delta R_{12}}{R_{12}} \right)$$

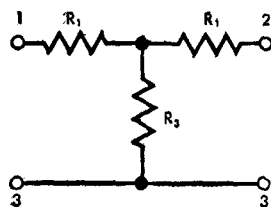

equivalent symmetrical
T section

Table VI—Bridged T or H attenuator

$Z = 500$ ohms resistive $R_1 = R_2 = 500$ ohms (diagram page 106)

attenuation db	bridge arm R_4 ohms	shunt arm R_3 ohms	attenuation db	bridge arm R_4 bhms	shunt arm R_3 ohms
0.0	0.0	∞	12.0	1,491	167.7
0.2	11.6	21,500	14.0	2,006	124.6
0.4	23.6	10,610	16.0	2,655	94.2
0.6	35.8	6,990	18.0	3,472	72.0
0.8	48.2	5,180	20.0	4,500	55.6
1.0	61.0	4,100	25.0	8,390	29.8
2.0	129.5	1,931	30.0	15,310	16.33
3.0	206.3	1,212	40.0	49,500	5.05
4.0	292.4	855	50.0	157,600	1.586
5.0	389.1	642	60.0	499,500	0.501
6.0	498	502	80.0	5.00×10^6	0.0500
7.0	619	404	100.0	50.0×10^6	0.00500
8.0	756	331			
9.0	909	275.0			
10.0	1,081	231.2			

Attenuators *continued*

Interpolation of bridged T or H attenuators

Bridge arm R_4 : Use the formula $\log_{10} (R_4 + 500) = 2.699 + \frac{\text{db}}{20}$ for $Z = 500$ ohms. However, if preferred, the tabular values of R_4 may be interpolated linearly, between 0 and 10 db only.

Shunt arm R_3 : Do not interpolate R_3 column. Compute R_3 by the formula

$$R_3 = \frac{10^6}{4R_4} \quad \text{for } Z = 500 \text{ ohms.}$$

Note: For attenuators of 60 db and over, the bridge arm R_4 may be omitted, provided a shunt arm is used having twice the resistance tabulated in the R_3 column. (This makes the input impedance 0.1 of 1 percent high at 60 db.)

Errors in bridged T or H attenuators

For resistance of any one arm 10 percent higher than the correct value

designed loss db	col 1* db	col 2* percent	col 3* percent
0.2	0.01	0.005	0.2
1	0.05	0.1	1.0
6	0.2	2.5	2.5
12	0.3	5.6	1.9
20	0.4	8.1	0.9
40	0.4	10	0.1
100	0.4	10	0.0

*Refer to following tabulation.

element in error (10 percent high)	error in loss	error in terminal impedance	remarks
Series arm R_1 (analogous for arm R_2)	Zero	Col 2, for adjacent terminals	Error in impedance at opposite terminals is zero
Shunt arm R_3	-Col 1	Col 3	Loss is lower than designed loss
Bridge arm R_4	+Col 1	Col 3	Loss is higher than designed loss

Error in input impedance: $\frac{\Delta Z_1}{Z_1} = \left(\frac{K-1}{K}\right)^2 \frac{\Delta R_1}{R_1} + \frac{K-1}{K^2} \left(\frac{\Delta R_3}{R_3} + \frac{\Delta R_4}{R_4}\right)$

For $\frac{\Delta Z_2}{Z_2}$ use subscript 2 in formula in place of subscript 1.

Error in output current: $\frac{\Delta i}{i} = \frac{K-1}{2K} \left(\frac{\Delta R_3}{R_3} - \frac{\Delta R_4}{R_4}\right)$

See General Remarks on page 101.

Attenuators *continued***Table VII—Minimum loss pads**Matching Z_1 and Z_2 — both resistive (diagram page 106)

Z_1 ohms	Z_2 ohms	$\frac{Z_1}{Z_2}$	loss db	series arm R_1 ohms	shunt arm R_3 ohms
10,000	500	20.00	18.92	9,747	513.0
8,000	500	16.00	17.92	7,746	516.4
6,000	500	12.00	16.63	5,745	522.2
5,000	500	10.00	15.79	4,743	527.0
4,000	500	8.00	14.77	3,742	534.5
3,000	500	6.00	13.42	2,739	547.7
2,500	500	5.00	12.54	2,236	559.0
2,000	500	4.00	11.44	1,732	577.4
1,500	500	3.00	9.96	1,224.7	612.4
1,200	500	2.40	8.73	916.5	654.7
1,000	500	2.00	7.66	707.1	707.1
800	500	1.60	6.19	489.9	816.5
600	500	1.20	3.77	244.9	1,224.7
500	400	1.25	4.18	223.6	894.4
500	300	1.667	6.48	316.2	474.3
500	250	2.00	7.66	353.6	353.6
500	200	2.50	8.96	387.3	258.2
500	160	3.125	10.17	412.3	194.0
500	125	4.00	11.44	433.0	144.3
500	100	5.00	12.54	447.2	111.80
500	80	6.25	13.61	458.3	87.29
500	65	7.692	14.58	466.4	69.69
500	50	10.00	15.79	474.3	52.70
500	40	12.50	16.81	479.6	41.70
500	30	16.67	18.11	484.8	30.94
500	25	20.00	18.92	487.3	25.65

Interpolation of minimum loss pads

This table may be interpolated linearly with respect to Z_1 , Z_2 , or $\frac{Z_1}{Z_2}$ except when $\frac{Z_1}{Z_2}$ is between 1.0 and 1.2. The accuracy of the interpolated value becomes poorer as $\frac{Z_1}{Z_2}$ passes below 2.0 toward 1.2, especially for R_3 .

Attenuators *continued*
For other terminations

If the terminating resistances are to be Z_A and Z_B instead of Z_1 and Z_2 , respectively, the procedure is as follows. Enter the table at $\frac{Z_1}{Z_2} = \frac{Z_A}{Z_B}$ and read the loss and the tabular values of R_1 and R_3 . Then the series and shunt arms are, respectively, MR_1 and MR_3 , where $M = \frac{Z_A}{Z_1} = \frac{Z_B}{Z_2}$.

Errors in minimum loss pads

impedance ratio $\frac{Z_1}{Z_2}$	col 1* db	col 2* percent	col 3* percent
1.2	0.2	+4.1	+1.7
2.0	0.3	7.1	1.2
4.0	0.35	8.6	0.6
10.0	0.4	9.5	0.25
20.0	0.4	9.7	0.12

*** Notes**

Series arm R_1 10 percent high: Loss is increased by col 1. Input impedance Z_1 is increased by col 2. Input impedance Z_2 is increased by col 3.

Shunt arm R_3 10 percent high: Loss is decreased by col 1. Input impedance Z_2 is increased by col 2. Input impedance Z_1 is increased by col 3.

Errors in input impedance

$$\frac{\Delta Z_1}{Z_1} = \sqrt{1 - \frac{Z_2}{Z_1} \left(\frac{\Delta R_1}{R_1} + \frac{1}{N} \frac{\Delta R_3}{R_3} \right)}$$

$$\frac{\Delta Z_2}{Z_2} = \sqrt{1 - \frac{Z_2}{Z_1} \left(\frac{\Delta R_3}{R_3} + \frac{1}{N} \frac{\Delta R_1}{R_1} \right)}$$

Error in output current, working either direction

$$\frac{\Delta i}{i} = \frac{1}{2} \sqrt{1 - \frac{Z_2}{Z_1} \left(\frac{\Delta R_3}{R_3} - \frac{\Delta R_1}{R_1} \right)}$$

See General Remarks on page 101.

Attenuators *continued***Table VIII—Miscellaneous T and H pads**

(diagram page 106)

resistive terminations		loss db	attenuator arms		
Z ₁ ohms	Z ₂ ohms		series R ₁ ohms	series R ₂ ohms	shunt R ₃ ohms
5,000	2,000	10	3,889	222	2,222
5,000	2,000	15	4,165	969	1,161
5,000	2,000	20	4,462	1,402	639
5,000	500	20	4,782	190.7	319.4
2,000	500	15	1,763	165.4	367.3
2,000	500	20	1,838	308.1	202.0
2,000	200	20	1,913	76.3	127.8
500	200	10	388.9	22.2	222.2
500	200	15	416.5	96.9	116.1
500	200	20	446.2	140.2	63.9
500	50	20	478.2	19.07	31.94
200	50	15	176.3	16.54	36.73
200	50	20	183.8	30.81	20.20

Errors in T and H padsSeries arms R₁ and R₂ in error. Error in input impedances:

$$\Delta Z_1 = \Delta R_1 + \frac{1}{N} \frac{Z_1}{Z_2} \Delta R_2 \quad \text{and} \quad \Delta Z_2 = \Delta R_2 + \frac{1}{N} \frac{Z_2}{Z_1} \Delta R_1$$

Error in insertion loss, db = $4 \left(\frac{\Delta R_1}{Z_1} + \frac{\Delta R_2}{Z_2} \right)$, approximately.**Shunt arm R₃ in error (10 percent high)**

$\frac{Z_1}{Z_2}$	designed loss db	error in loss db	error in input impedance	
			100 $\frac{\Delta Z_1}{Z_1}$	100 $\frac{\Delta Z_2}{Z_2}$
2.5	10	-0.4	1.1%	7.1%
2.5	15	-0.6	1.2	4.6
2.5	20	-0.7	0.9	2.8
4.0	15	-0.5	0.8	6.0
4.0	20	-0.65	0.6	3.6
10	20	-0.6	0.3	6.1

$$\frac{\Delta Z_1}{Z_1} = \frac{2}{N-1} \left(\sqrt{\frac{N Z_2}{Z_1}} + \sqrt{\frac{Z_1}{N Z_2}} - 2 \right) \frac{\Delta R_3}{R_3} \left\{ \text{for } \frac{\Delta Z_2}{Z_2} \text{ interchange subscripts 1 and 2.} \right.$$

$$\frac{\Delta i}{i} = \frac{N+1 - \sqrt{N} \left(\sqrt{\frac{Z_1}{Z_2}} + \sqrt{\frac{Z_2}{Z_1}} \right)}{N-1} \frac{\Delta R_3}{R_3} \left\{ \text{where } i \text{ is the output current.} \right.$$

Filter networks

Explanation: Table IX shows, in the first column, the fundamental series impedance, Z_1 , and the fundamental shunt impedance, Z_2 , from which the various types of filter sections shown in subsequent columns are composed. For example, a T section (third column) is composed of two half-series arms, $\frac{Z_1}{2}$ in series, with a full shunt arm Z_2 connected to their junction point. The subsequent tables (Tables X, XI, XII, and XIII) give formulas for computing the full series arm and the full shunt arm. These must then be modified according to the type of section used.

Example: Design a series M derived high-pass, T-section filter to terminate in 500 ohms, with cutoff frequency equal to 1000 cycles, and peak attenuation frequency equal to 800 cycles.

Using Table XIII:

$$\begin{aligned} f_c &= 1000 \\ f_\infty &= 800 \\ R &= 500 \end{aligned}$$

$$m = \sqrt{1 - \left(\frac{800}{1000}\right)^2} = 0.6$$

$$C = \frac{1}{4\pi f_c R} = \frac{1}{4\pi \times 1000 \times 500} = 0.159(10^{-6}) \text{ farad} = 0.159 \text{ microfarad}$$

$$L = \frac{R}{4\pi f_c} = \frac{500}{4\pi \times 1000} = 0.0398 \text{ henry} = 39.8 \text{ millihenry}$$

$$C_1 = \frac{C}{m} = \frac{0.159}{0.6} = 0.265 \text{ microfarad}$$

$$L_2 = \frac{L}{m} = \frac{39.8}{0.6} = 66.3 \text{ millihenry}$$

$$C_2 = \frac{4m}{1 - m^2} C = \frac{4 \times 0.6 \times 0.159}{0.64} = 0.597 \text{ microfarad}$$

For a T-section, each series arm must be $\frac{Z_1}{2}$ while the full shunt arm is used.

Thus for the series arm use $2C_1$, or 0.53 microfarad. The accompanying figure shows the final result.

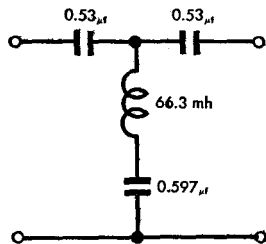

Filter networks *continued***Table IX—Combination of filter elements**

configuration	half-section	full T-section	full π -section
			

Table X—Band-pass filters

type	configuration	series arm	shunt arm	notations
Constant K		$L_1 = \frac{R}{\pi(f_2 - f_1)}$ $C_1 = \frac{f_2 - f_1}{4\pi f_2 f_1 R}$	$L_2 = \frac{f_2 - f_1}{4\pi f_1 f_2} R$ $C_2 = \frac{1}{\pi(f_2 - f_1) R}$	f_2 = upper cutoff frequency f_1 = lower cutoff frequency R = nominal terminating resistance
Three element series type		$L_1 = \frac{R}{\pi(f_2 - f_1)}$ $C_1 = \frac{f_2 - f_1}{4\pi f_1^2 R}$	$C_2 = \frac{1}{\pi(f_1 + f_2) R}$	
Three element shunt type		$C_1 = \frac{f_1 + f_2}{4\pi f_1 f_2 R}$	$L_2 = \frac{f_2 - f_1}{4\pi f_1 f_2} R$ $C_2 = \frac{f_1}{\pi f_2(f_2 - f_1) R}$	

Table XI—Band-elimination filters

type	configuration	series arm	shunt arm	notations
Constant K		$L_1 = \frac{f_2 - f_1}{\pi f_1 f_2} R$ $C_1 = \frac{1}{4\pi(f_2 - f_1) R}$	$L_2 = \frac{R}{4\pi(f_2 - f_1)}$ $C_2 = \frac{f_2 - f_1}{\pi f_1 f_2 R}$	f_2 = upper cutoff frequency f_1 = lower cutoff frequency R = nominal terminating resistance

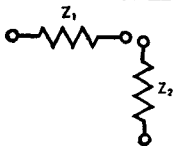
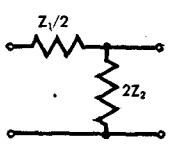
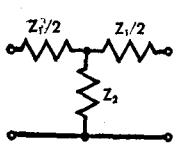
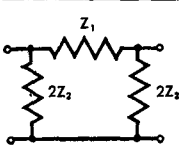
Filter networks *continued*

Table XII—Low-pass filters

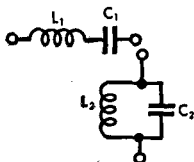
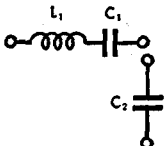
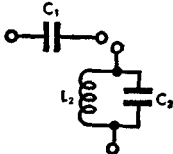
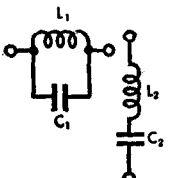

type	configuration	series arm	shunt arm	notations
Constant K		$L = \frac{R}{\pi f_c}$	$C = \frac{1}{\pi f_c R}$	$f_c =$ cutoff frequency
Series M derived		$L_1 = mL$	$L_2 = \frac{1 - m^2}{4m} L$ $C_2 = mC$	$f_\infty =$ frequency of peak attenuation $m = \sqrt{1 - \left(\frac{f_c}{f_\infty}\right)^2}$
Shunt M derived		$L_1 = mL$ $C_1 = \frac{1 - m^2}{4m} C$	$C_2 = mC$	$R =$ nominal terminating resistance

Table XIII—High-pass filters

type	configuration	series arm	shunt arm	notations
Constant K		$C = \frac{1}{4\pi f_c R}$	$L = \frac{R}{4\pi f_c}$	$f_c =$ cutoff frequency
Series M derived		$C_1 = \frac{C}{m}$	$L_2 = \frac{L}{m}$ $C_2 = \frac{4m}{1 - m^2} C$	$f_\infty =$ frequency of peak attenuation $m = \sqrt{1 - \left(\frac{f_\infty}{f_c}\right)^2}$
Shunt M derived		$C_1 = \frac{C}{m}$ $L_1 = \frac{4m}{1 - m^2} L$	$L_2 = \frac{L}{m}$	$R =$ nominal terminating resistance

■ Rectifiers and filters

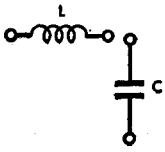
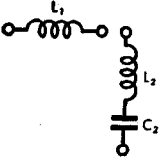
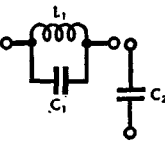
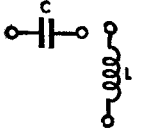
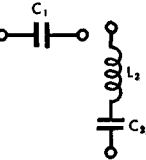
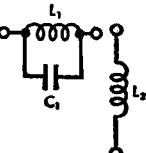
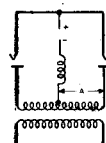
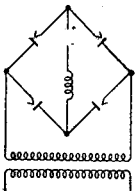
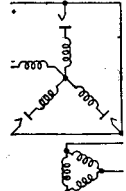
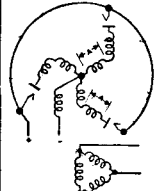
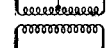
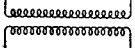
Typical rectifier circuit

type of circuit	rectifier	single-phase full-wave	single-phase full-wave (bridge)	3-phase half-wave	3-phase half-wave
	transformer	single-phase center-tap	single-phase	delta-wye	delta-zig zag
secondaries					
primaries					
Number of phases of supply	1	1	3	3	
Number of tubes*	2	4	3	3	
Ripple voltage	0.48	0.48	0.18	0.18	
Ripple frequency	2f	2f	3f	3f	
line voltage	1.11	1.11	0.855	0.855	
line current	1	1	0.816	0.816	
line power factor †	0.90	0.90	0.826	0.826	
Trans primary volts per leg	1.11	1.11	0.855	0.855	
Trans primary amperes per leg	1	1	0.471	0.471	
Trans primary kva	1.11	1.11	1.21	1.21	
Trans average kva	1.34	1.11	1.35	1.46	
Trans secondary volts per leg	1.11 (A)	1.11	0.855	0.493 (A)	
Trans secondary amperes per leg	0.707	1	0.577	0.577	
Transformer secondary kva	1.57	1.11	1.48	1.71	
Peak inverse voltage per tube	3.14	1.57	2.09	2.09	
Peak current per tube	1	1	1	1	
Average current per tube	0.5	0.5	0.338	0.333	

Unless otherwise stated, factors shown express the ratio of the RMS value of the circuit quantities designated to the average DC output values of the rectifier. Factors are based on a sine wave voltage input, infinite impedance choke and no transformer or rectifier losses.

connections and circuit data

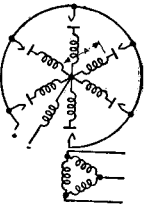
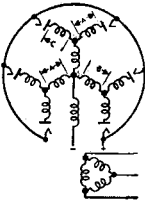
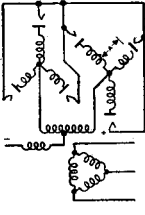
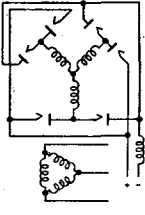
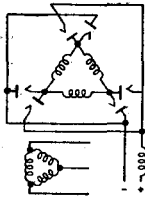
6-phase half-wave delta-star	6-phase half-wave delta-6-phase fork	6-phase (double 3-phase) half-wave delta-double wye with balance coil	3-phase full-wave delta-wye	3-phase full-wave delta-delta
				
3 6	3 6	3 6	3 6	3 6
0.042 6f	0.042 6f	0.042 6f	0.042 6f	0.042 6f
0.740 0.816 0.955	0.428 1.41 0.955	0.855 0.707 0.955	0.428 1.41 0.955	0.740 0.816 0.955
0.740 0.577 1.28	0.428 0.816 1.05	0.855 0.408 1.05	0.428 0.816 1.05	0.740 0.471 1.05
1.55	1.42	1.26	1.05	1.05
0.740(A) 0.408 1.81	0.428(A) { 0.577(B) } { 0.408(C) } 1.79	0.855(A) 0.289 1.48	0.428 0.816 1.05	0.740 0.471 1.05
2.09 1 0.167	2.09 1 0.167	2.42 0.5 0.167	1.05 1 0.333	1.05 1 0.333

* These circuit factors are equally applicable to tube or dry plate rectifying elements.
 † Line PF = DC output watts/line volt-amperes

Rectifier filter design

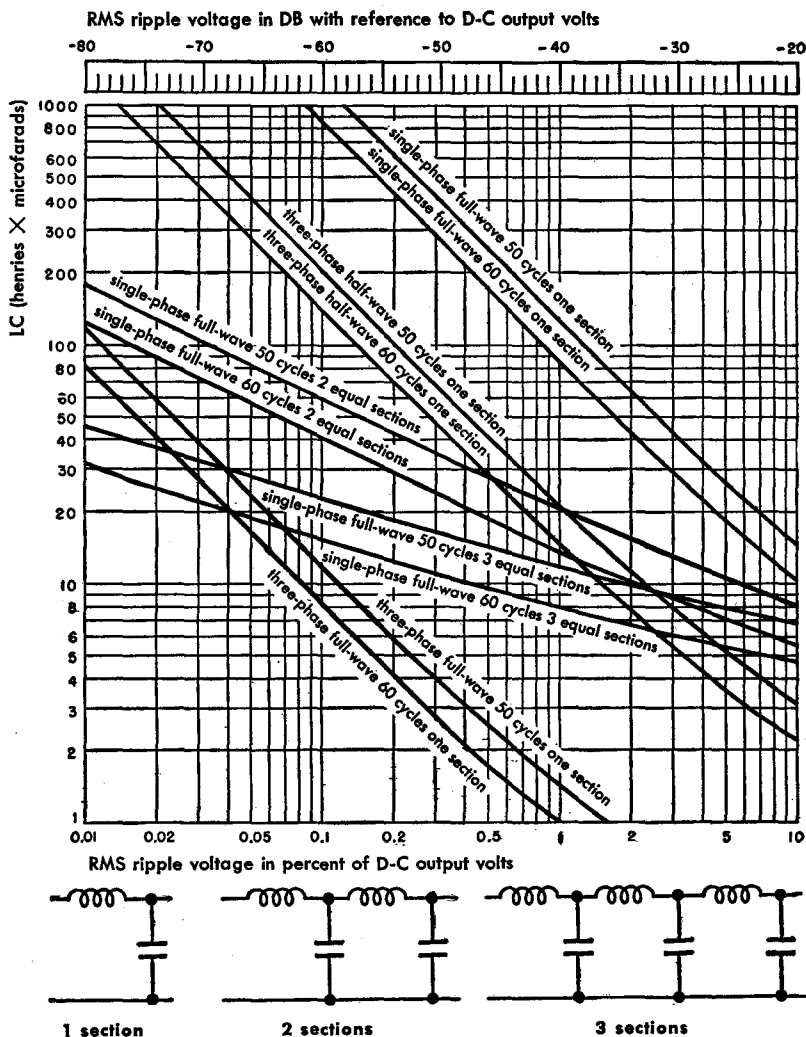

Ripple voltage vs LC for choke-input filters

Minimum inductance for a choke-input filter is determined from

$$L = \frac{KE}{If}$$

where

L = minimum inductance in henries

E = d-c output in volts

I = output current in amperes

f = supply frequency in cps

$K = 0.0527$ for full-wave, single-phase

$= 0.0132$ for half-wave, three-phase

$= 0.0053$ for full-wave, two-phase

$= 0.0016$ for full-wave, three-phase

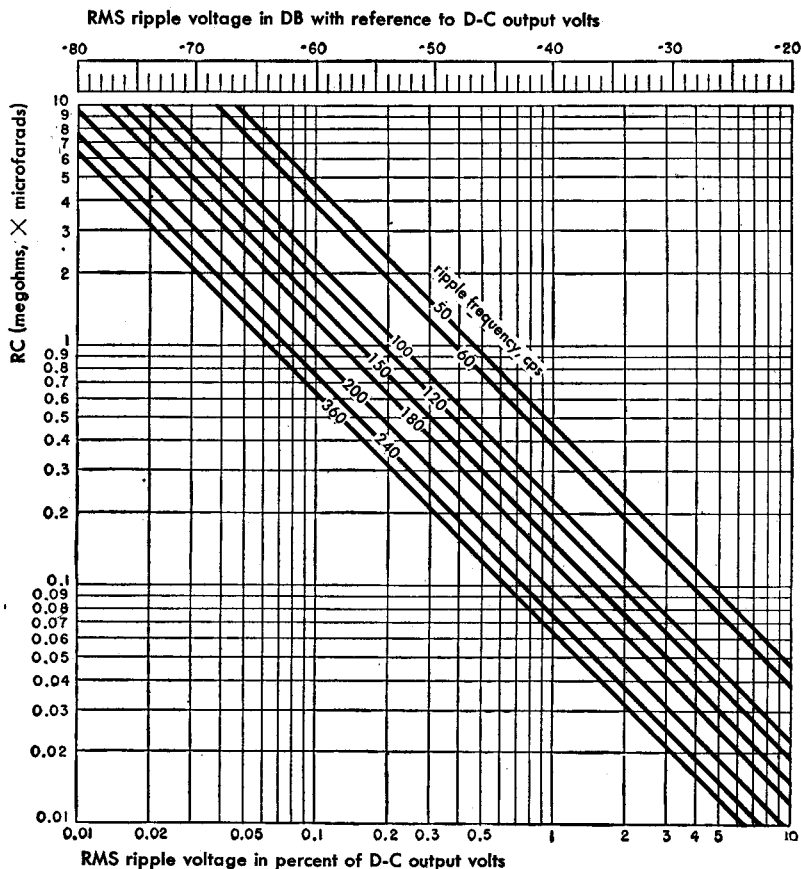
Rectifier filter design *continued***Ripple voltage vs RC for capacitor-input filters**

The above chart applies to a capacitance filter with resistance load as shown at the right.

For each additional $R'C'$ section, obtain R by adding a resistance and add $db = 104 - 20 \log fR'C'$.

For each additional LC' section, add $db = 882 - 40 \log f - 20 \log LC'$.

The above assumes that the impedance of C' is small with respect to that of R , R' , and L .

f = ripple frequency in cps

R' = series filter resistance in ohms

C' = shunt filter capacitance in microfarads

L = series filter inductance in henries.

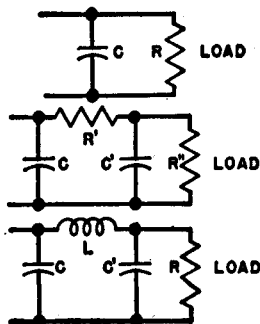

■ Iron-core transformers and reactors

Major transformer types

1. Audio transformers: Carry audio communication frequencies or some single control frequency.

a. Input transformers: Couple a signal source, e.g., microphone or line, to the grid(s) of an amplifier.

b. Interstage transformers (usually step-up voltage): Couple the plate(s) of a vacuum tube (except a driver stage) to the grid(s) of a succeeding stage of amplification.

c. Output transformers: Couple the plate(s) of an amplifier to an output load.

d. Driver transformers (usually step-down voltage): Couple the plate(s) of a driver stage (pre-amplifier) to the grid(s) of an amplifier stage in which grid current is drawn.

e. Modulation transformers: Couple the plate(s) of an audio output stage to the grid or plate of a modulated amplifier.

2. Power supply transformers: Supply appropriate plate and/or filament voltage to vacuum tubes in a unit of equipment.

a. Plate transformers: Supply potential to the plate(s) of high-vacuum or gas-filled tube(s) in a rectifier circuit.

b. Filament transformers: Supply current to heat the filaments of vacuum or gas-filled tubes.

c. Plate-filament transformers: Combinations of 2a and 2b.

d. Isolation transformers: Insulate or isolate two circuits, such as a grounded circuit from an ungrounded circuit.

e. Scott-transformers: Scott-connection utilizes two transformers to transmit power from two-phase to three-phase systems, or vice versa.

f. Auto-transformers: Provide increased or decreased voltage by means of a single winding suitably tapped for the primary and secondary circuits, part of the winding being common to both circuits.

Major reactor types

1. Reactors: Single-winding units that smooth current flow, provide d-c feed, or act as frequency-selective units (in suitable arrangement with capacitors).

a. Audio reactors: Single-winding units that supply plate current to a vacuum tube in parallel with the output circuit.

Major reactor types *continued*

- b. Wave-filter reactors: Function as filter unit components which aid in the acceptance or rejection of certain frequencies.
- c. Filter reactors: Smooth the d-c output current in rectifier circuits.
- d. Saturable reactors: Regulate voltage, current, or phase in conjunction with glow-discharge tubes of the thyatron type. They are also used as voltage-regulating devices with dry-type rectifiers.

Temperature, humidity, and pressure effects

A maximum ambient temperature of 40° C is usually assumed. Final operating temperatures with organic insulation (Class A), such as silk, cotton, or paper, are restricted to values less than 95° C. When weight and space requirements dictate undersized iron cores and wire, with resultant higher temperature rise, inorganic insulation and cooling expedients may be used. Cooling expedients include: open-frame; semi-enclosed (coil-covered, core-exposed) design; and fully-enclosed design having compound or liquid-filled insulant and cooling by convection, or forced cooling by air blast.

Relative humidities from zero to 97 percent should be assumed so that coils and leads should be impregnated with moisture-resistant insulating coatings or, alternatively, cases should be sealed vacuum tight. Pressure variation, in addition to moisture and temperature changes, due to altitude from sea-level up to 7,000 feet (greater for aircraft) may be encountered.

General limitations**Core material**

- a. For audio transformers and reactors: Core material should be such that core distortion is not greater than 0.75 percent at the lowest frequency.
- b. For power supply transformers: Core loss should be less than 0.82 watts per pound at 60 cps, for a flux density of 10,000 gauss. Filter reactors may have a core loss of 1.2 watts per pound at 60 cps, for 10,000 gauss.

Terminal facilities

- a. All leads or winding ends: Must remain inside the case for hermetically sealed units.
- b. Leads may terminate: In studs in a Bakelite board or bushing when voltage is less than 1000 volts peak. For higher voltages, Isolantite or wet process porcelain may be used.

Protective gaps

Protective gaps are frequently used on filter reactors or plate transformers in rectifier circuits delivering more than 1000 volts dc.

Design of power-supply transformers

The following may be used as a guide in the design of power supply transformers for receivers and small transmitters.

Nomenclature

- A_c = ab = cross section area of core, in square inches
 a = stack width in inches
 b = stack height in inches
 B_{max} = maximum core flux density in gauss. Usually assumed to be 10,000 gauss (64.5 kilolines per square inch) at 60 cps, or 12,000 gauss at 25 cps
 E_p = primary terminal voltage
 E_s = secondary terminal voltage
 f = frequency in cycles per second
 h = minimum height of a coil section above core in inches
 h' = maximum height of a coil section above core in inches
 K = stacking factor (usually $K = 0.9$)
 MLT = mean length of turn of a coil section in feet
 T_p = number of primary turns
 T_s = number of secondary turns
 VD_p = voltage drop due to primary resistance
 VD_s = voltage drop due to secondary resistance

Design procedure

1. Determine secondary output volt-ampere requirements.
2. Calculate primary current based on a wattage 10 percent greater than the volt-amperes determined in (1). Use the given primary voltage E_p .
3. The core area is determined roughly by the formula

$$\text{Core area} = \frac{\sqrt{\text{wattage}}}{5.58} \sqrt{\frac{60}{f}}$$

Select a lamination (from a transformer manufacturer's lamination data book) that will fit the transformer space requirements and provide the proper core area when stacked to a sufficient height.

4. Compute the number of primary turns $T_p = \frac{E_p \times 10^8}{4.44 f B_{max} A_c K}$
5. Compute the number of secondary turns $T_s = \frac{E_s}{E_p} T_p$
6. Determine the wire sizes needed for primary and secondary on the basis of an optimum current density of 1000 amperes per square inch, using Table I and the currents carried by the primary and secondary. Greater or smaller densities may be used as required. For very small transformers, densities up to 2500 amperes per square inch are sometimes used.

Design of power-supply transformers *continued*

7. Calculate the number of turns per layer that can be placed in the lamination window space, deducting margin space from the window length.
8. From this value, calculate the total number of primary and secondary layers needed.
9. Calculate the total wire height, using the wire diameter and the number of layers.
10. Determine the total insulation thickness required between wire layers (from Table I), and under and over coil sections.
11. Add the results of (9) and (10) and multiply the figure obtained by 10/9 to allow for bulge in winding wire and wrapping insulation. Revise the design, as necessary, to make this over-all thickness figure (coil build) slightly less than the lamination window width.
12. Calculate the mean length of turns for the primary and for each secondary coil section

$$MLT = \frac{2a + 2b + 2\pi \frac{(h' + h)}{2}}{12}$$

13. Calculate the total wire length in feet of each primary and secondary coil by multiplying the *MLT* value of the coil by the corresponding total number of turns in that coil.
14. The resistance of each coil is obtained by multiplying the total wire length obtained above by the resistance per foot.
15. Calculate the voltage drop in each primary and secondary from the calculated resistance and the current flow.
16. Compensate for the voltage drop in the primary and in each secondary by determining the corrected number of turns

$$(\text{corrected } T_p) = \frac{E_p - VD_p}{E_p} \times (\text{original } T_p)$$

$$(\text{corrected } T_s) = \frac{E_s + VD_s}{E_s} \times (\text{original } T_s)$$

17. Revise the number of layers of each winding according to the corrected number of turns.
18. Calculate the copper loss in both primary and secondary windings from the resistance of each coil times the square of the current flowing in it.

Design of power-supply transformers *continued*

19. Calculate the core loss from the weight (in pounds) of the core used and the core loss per pound obtained from the core loss curve given by the manufacturer for the iron used.

20. The efficiency of the transformer is

$$\text{Percent efficiency} = \frac{\text{wattage output} \times 100}{\text{wattage output} + \text{core loss} + \text{copper loss}}$$

Table I—Round enameled copper wire

AWG (B&S)	diameter inches	turns per inch	current capacity amperes*	ohms per 1000 ft at 50° C	coil margin inches	interlayer insulation† inches
10	0.1039	9	8.2	1.12	0.25	0.010
11	0.0927	10	6.5	1.41	0.25	0.010
12	0.0827	11	5.1	1.78	0.25	0.010
13	0.0738	12	4.1	2.24	0.25	0.010
14	0.0659	13	3.2	2.82	0.25	0.010
15	0.0588	14	2.6	3.56	0.188	0.010
16	0.0524	16	2.0	4.49	0.188	0.010
17	0.0469	19	1.61	5.66	0.188	0.010
18	0.0418	21	1.28	7.14	0.125	0.005
19	0.0374	24	1.01	9.0	0.125	0.005
20	0.0334	26	0.80	11.4	0.125	0.005
21	0.0299	30	0.64	14.3	0.125	0.005
22	0.0266	34	0.50	18.1	0.125	0.003
23	0.0238	39	0.40	22.8	0.125	0.003
24	0.0213	43	0.32	28.7	0.125	0.003
25	0.0190	48	0.25	36.2	0.125	0.002
26	0.0169	54	0.20	45.6	0.125	0.002
27	0.0152	59	0.158	57.5	0.125	0.002
28	0.0135	68	0.126	72.6	0.125	0.002
29	0.0122	74	0.100	91	0.125	0.002
30	0.0108	84	0.079	115	0.125	0.0015
31	0.0097	94	0.063	146	0.125	0.0015
32	0.0088	104	0.050	183	0.094	0.0015
33	0.0078	117	0.039	231	0.094	0.0015
34	0.0069	131	0.031	292	0.094	0.001
35	0.0061	146	0.025	368	0.094	0.001
36	0.0055	162	0.0196	464	0.094	0.001
37	0.0049	183	0.0156	585	0.094	0.001
38	0.0044	204	0.0124	737	0.063	0.001
39	0.0038	227	0.0098	930	0.063	0.00075
40	0.0034	261	0.0078	1173	0.063	0.00075

* Current capacity at 1000 amperes per square inch. For other current densities, multiply by (current density)/1000.

† Interlayer insulation is usually Kraft paper.
See also page 60.

■ Vacuum tubes

Nomenclature*

- e_c = instantaneous total grid voltage
- e_b = instantaneous total plate voltage
- i_c = instantaneous total grid current
- i_b = instantaneous total plate current
- E_c = average value of grid voltage
- E_b = average or quiescent value of plate voltage
- I_c = average or quiescent value of grid current
- I_b = average or quiescent value of plate current
- e_g = instantaneous value of varying component of grid voltage
- e_p = instantaneous value of varying component of plate voltage
- i_g = instantaneous value of varying component of grid current
- i_p = instantaneous value of varying component of plate current
- E_g = effective or maximum value of varying component of grid voltage
- E_p = effective or maximum value of varying component of plate voltage
- I_g = effective or maximum value of varying component of grid current
- I_p = effective or maximum value of varying component of plate current
- I_f = filament or heater current
- I_s = total electron emission (from cathode)
- r_l = external plate load resistance
- C_{gp} = grid-plate direct capacitance
- C_{gk} = grid-cathode direct capacitance
- C_{pk} = plate-cathode direct capacitance
- θ_p = plate current conduction angle
- r_p = variational (a-c) plate resistance
- R_{pb} = total (d-c) plate resistance

Note: In the following text, the superscript M indicates the use of the maximum or peak value of the varying component, i.e., ${}^M E_p$ = maximum or peak value of the alternating component of the plate voltage.

* From IRE standard symbols (Electronics Standards, 1938)

Coefficients

Amplification factor μ : Ratio of incremental plate voltage to control-electrode voltage change at a fixed plate current with constant voltage on other electrodes.

$$\mu = \left. \begin{array}{l} \left[\frac{\delta e_b}{\delta e_{c1}} \right] I_b \\ E_{c2} \text{-----} E_{cn} \end{array} \right\} \text{constant}$$

$r_l = 0$

Coefficients *continued*

Transconductance s_m : Ratio of incremental plate current to control-electrode voltage change at constant voltage on other electrodes.

$$s_m = \left[\frac{\delta i_b}{\delta e_{c1}} \right]_{E_b, E_{c2}, \dots, E_{cn} \text{ constant}} \\ r_i = 0$$

When electrodes are plate and control grid, the ratio is the *mutual conductance* g_m of the tube.

$$g_m = \frac{\mu}{r_p}$$

Variational (a-c) plate resistance r_p : Ratio of incremental plate voltage to current change at constant voltage on other electrodes.

$$r_p = \left[\frac{\delta e_b}{\delta i_b} \right]_{E_{c1}, \dots, E_{cn} \text{ constant}} \\ r_i = 0$$

Total (d-c) plate resistance R_p : Ratio of total plate voltage to current for constant voltage on other electrodes.

$$R_p = \left[\frac{e_b}{i_b} \right]_{E_{c1}, \dots, E_{cn} \text{ constant}} \\ r_i = 0$$

Terminology

Control grid: Electrode to which plate-current-controlling signal voltage is applied.

Space-charge grid: Electrode, usually biased to constant positive voltage, placed adjacent to cathode to reduce current-limiting effect of space charge.

Suppressor grid: Grid placed between two electrodes to suppress the effect of secondary electrons.

Screen grid: Grid placed between anode and control grid to reduce the capacitive coupling between them.

Primary emission: Thermionic emission of electrons from a surface.

Secondary emission: Usually of electrons, from a surface by direct impact not thermal action, of electronic or ionic bombardment.

Total emission I_s : Maximum (saturated, temperature-limited) value of electron current which may be drawn from a cathode. *Available total emission* is that peak value of current which may safely be drawn.

Terminology *continued*

Transfer characteristic: Relation, usually graphical, between voltage on one electrode and current to another, voltages on all other electrodes remaining constant.

Electrode characteristic: Relation, usually graphical, between the voltage on, and current to, a tube electrode, all other electrode voltages remaining constant.

Composite-diode lines: Relation, usually two curves, of the currents flowing to the control grid and the anode of a triode as a function of the equal voltage applied to them (grid-plate tied).

Critical grid voltage: Instantaneous value of grid voltage (with respect to cathode) at which anode current conduction is initiated through a gas tube.

Constant current characteristics: Relation, usually graphical, between the voltages on two electrodes, for constant specified current to one of them and constant voltages on all other electrodes.

Formulas

For unipotential cathode and negligible saturation of cathode emission

function	parallel plane cathode and plate	cylindrical cathode and plate
Diode plate current (amperes)	$G_1 e_b^{\frac{3}{2}}$	$G_1 e_b^{\frac{3}{2}}$
Triode plate current (amperes)	$G_2 \left(\frac{e_b + \mu e_c}{1 + \mu} \right)^{\frac{3}{2}}$	$G_2 \left(\frac{e_b + \mu e_c}{1 + \mu} \right)^{\frac{3}{2}}$
Diode perveance G_1	$2.3 \times 10^{-6} \frac{A_b}{d_b^2}$	$2.3 \times 10^{-6} \frac{A_b}{\beta^2 r_b^2}$
Triode perveance G_2	$2.3 \times 10^{-6} \frac{A_b}{d_b d_c}$	$2.3 \times 10^{-6} \frac{A_b}{\beta^2 r_b r_c}$
Amplification factor μ	$2.7 d_c \left(\frac{d_b}{d_c} - 1 \right)$	$2\pi d_c \log \frac{d_b}{d_c}$
	$\rho \log \frac{\rho}{2\pi r_g}$	$\rho \log \frac{\rho}{2\pi r_g}$
Mutual conductance g_m	$1.5 G_2 \frac{\mu}{\mu + 1} \sqrt{e'_g}$	$1.5 G_2 \frac{\mu}{\mu + 1} \sqrt{e'_g}$
	$e'_g = \frac{E_b + \mu E_c}{1 + \mu}$	$e'_g = \frac{E_b + \mu E_c}{1 + \mu}$

Formulas *continued*

where

A_b = effective anode area in square centimeters

d_b = anode-cathode distance in centimeters

d_c = grid-cathode distance in centimeters

β = geometrical constant, a function of ratio of anode to cathode radius;

$$\beta^2 \cong 1 \text{ for } \frac{r_b}{r_k} > 10 \text{ (see curve Fig. 1)}$$

ρ = pitch of grid wires in centimeters

r_g = grid wire radius in centimeters

r_b = anode radius in centimeters

r_k = cathode radius in centimeters

r_c = grid radius in centimeters

Note: These formulas are based on theoretical considerations and do not provide accurate results; for practical structures, however, they give a fair idea of the relationship between the tube geometry and the constants of the tube.

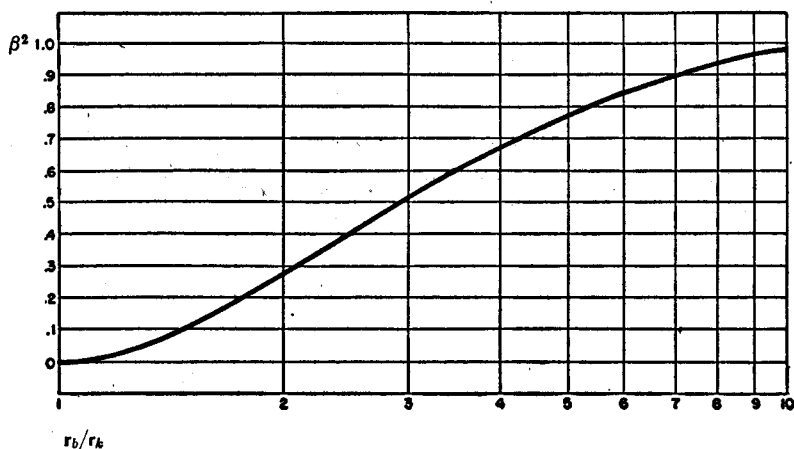

Fig. 1—Values of β^2 for values of $\frac{r_b}{r_k} < 10$.

Performance limitations

Tube performance limitation factors include electrode dissipation, filament emission, and the transit time of electrons in the active part of the tube. For a given tube, the ultimate limitation may be any one or a combination of these factors.

Electrode dissipation data

Tube performance is limited by electrode dissipation. In turn, tube dissipation is limited by the maximum safe operating temperatures of the glass-to-metal seals (approximately 200° C), glass envelope, and tube electrodes. Thus excessive dissipation may result in breakage, loss of vacuum, and destruction of the tube.

Typical operating data for common types of cooling are roughly

type	average cooling surface temperature °C	specific dissipation watts/cm ² of cooling surface	cooling medium supply
Radiation	400-1000	4-10	
Water	30-60	30-110	0.25-0.5 gpm per kw
Forced-air	150-200	0.5-1	50-150 cfm per kw

The operating temperature of radiation-cooled anodes for a given dissipation is determined by the relative total emissivity of the anode material. Thus, graphite electrodes which approach black-body radiation conditions operate at the lower temperature range indicated, while untreated tantalum and molybdenum work at relatively high temperatures. In computing cooling-medium flow, a minimum velocity sufficient to insure turbulent flow at the dissipating surface must be maintained. In the case of water and forced-air cooled tubes, the figures above apply to clean cooling surfaces, and may be reduced to a small fraction of these values by heat-insulating coatings such as mineral scale or dust. Cooling surfaces should, thus, be closely observed and cleaned periodically.

Dissipation and temperature rise of cooling water

$$KW = 0.264 Q(T_2 - T_1)$$

where KW = power in kilowatts, Q = flow in gallons per minute, T₂ and T₁ = outlet and inlet temperatures in degrees centigrade. An alternate formula is

$$KW = \frac{\text{liters per minute } (T_2 - T_1)}{14.3}$$

or KW = liters per minute when the temperature rise is a reasonable figure, namely 14.3° C.

Air flow and temperature rise

$$Q = 5.92 (T_1 + 273) \frac{P}{T_2 - T_1}$$

where Q = air flow in cubic feet per minute.

Filament characteristics

The sum of the instantaneous peak currents drawn by all of the electrodes must be within the available total emission of the filament. This emission is determined by the filament material, area, and temperature.

Typical data on the three types of filament most used are

type	efficiency ma/watt	specific emission I_s amp/cm ²	watt/cm ²	operating temperature Kelvin	ratio hot-to-cold resistance
Pure tungsten (W)	5-10	0.25-0.7	70-84	2500-2600	14:1
Thoriated tungsten (ThW)	40-100	0.5-3	26-28	1950-2000	10:1
Oxide coated (BaCaSr)	50-150	0.5-2.5	5-10	1100-1250	2.5 to 5.5:1

In the cases of thoriated-tungsten and oxide-coated filament tubes, the emission data vary widely between tubes around the approximate range indicated in the table. The figures for specific emission refer to the peak or saturated value which is usually two or more times the total available value for these filaments. Instantaneous peak current values drawn during operation should never exceed the published available emission figure for the given tube.

Thoriated-tungsten and oxide-coated type filaments should be operated close to the specified published voltage. Deviation from these values will result in rapid destruction of the cathode surface.

In the case of pure tungsten, the filament may be operated over a considerable temperature range. It should be borne in mind, however, that the total filament-emission current available varies closely as the seventh power of the filament voltage. Likewise, the expected filament life is critically dependent on the operating temperature. The relationship between filament voltage and life is shown by Fig. 2. It will be seen that an increase of 5 percent above rated filament voltage reduces the life expectancy by 50 percent. Where the full normal emission is not required, a corresponding increase in life may be secured by operating a pure tungsten filament below rated filament voltage.

From the above tabulated values of hot-to-cold resistance, it may be seen that a very high heating current may be drawn by a cold filament, particularly one of the tungsten type. In order to avoid destruction by mechanical stresses which are proportional to I^2 , it is imperative to limit the current to a safe value, say, 150 percent of normal hot value for large tubes and 250 percent for medium types. This may be accomplished by resistance and time-delay relays, high-reactance transformers, or regulators.

Filament characteristics *continued*

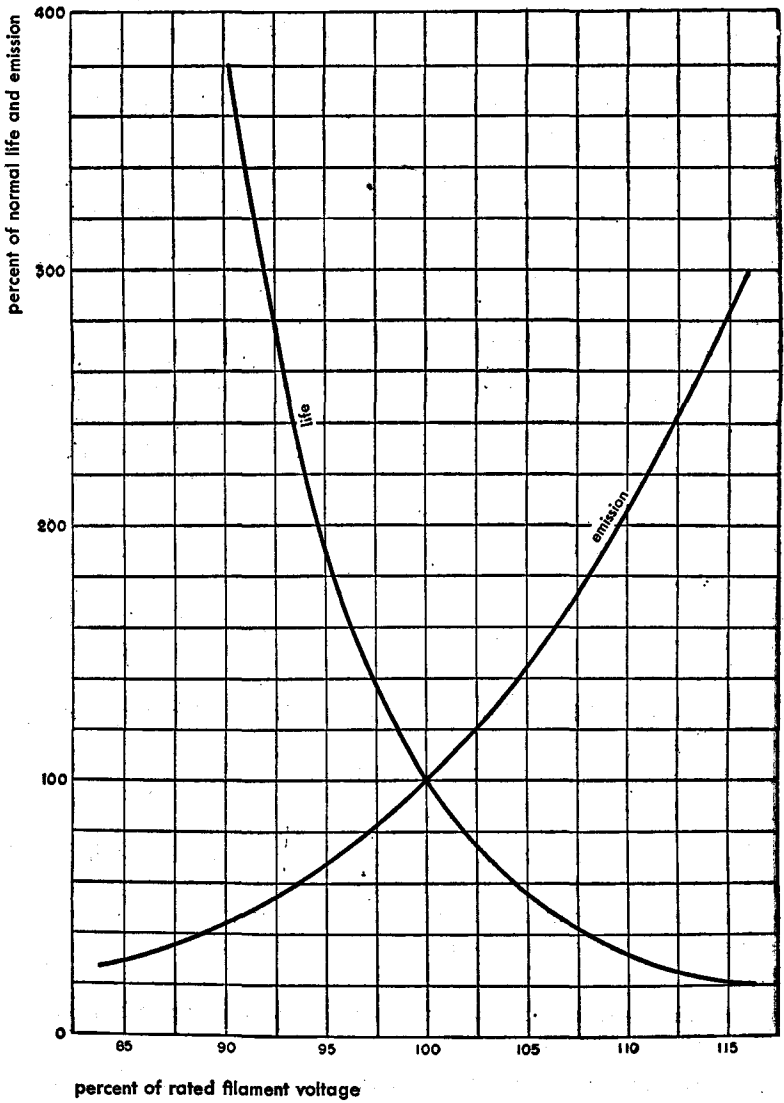

Fig. 2—Effect of change in filament voltage on the life and emission of bright tungsten filament (based on 2575° K normal temperature).

Filament characteristics *continued*

In the case where a severe overload has temporarily impaired the emission of a thoriated-tungsten filament, the activity can sometimes be restored by operating the tube with filament voltage only in accordance with one of the following schedules:

1. At normal filament voltage for several hours or overnight. Or, if the emission fails to respond.
2. At 30 percent above normal for 10 minutes, then at normal for 20 to 30 minutes. Or, in extreme cases when 1 and 2 have failed to give results and at the risk of burning out the filament.
3. At 75 percent above normal for 30 seconds followed by schedule 2.

Ultra-high-frequency tubes

Tubes for u-h-f application differ widely in design among themselves and from those for lower frequency. The theory of their operation and the principles of their design have not been fully expounded, and great progress in this field still lies ahead.

Ultra-high-frequency tubes may be classified according to principle of operation as follows:

1. Negative-grid tubes
2. Positive-grid tubes
3. Velocity-modulated tubes
4. Magnetrons

1. Negative-grid tubes: Effectiveness of negative-grid tubes at ultra-high-frequencies is limited by two factors

- a. difficulty of designing the circuit associated with the tube
- b. effect of electron inertia.

a. Design of u-h-f circuit associated with negative-grid tubes: The circuit must be tunable at the operating frequency. This leads to the use of transmission lines as associated circuits of the parallel or coaxial type. The tubes themselves are constructed so as to be part of the associated transmission line.

Lines in some cases are tuned on harmonic modes, thus making possible the use of larger circuit elements.

Circuit impedance must match the optimum loading impedance of the tube, a requirement difficult to satisfy inasmuch as the capacitive reactances are very small and u-h-f losses are important in both conductors and insulators. Difficulty in obtaining the proper Q of the circuit is increased with frequency.

Ultra-high-frequency tubes *continued*

b. Effect of electron inertia: The theory of electron inertia effect in receiving tubes has been formulated by Llewelyn, but no comparable, complete theory is now available for transmitting tubes. In both cases the time of flight of an electron from cathode to anode must be a small fraction of the oscillating period. When this period is so short as to be of the same order of magnitude as the transit time, receiving tubes cease to amplify and transmitting tubes cease to oscillate.

Small tubes with close spacing between electrodes have been built that can be operated up to about 3000 megacycles.

To compare results obtained with different tubes and circuits pertaining to a family ruled by the law of similitude, it is useful to know that dimensionless magnitudes, such as efficiency, or signal-noise ratio, are the same when the dimensionless parameter

$$\phi = \frac{f \times d}{\sqrt{V}} \text{ remains constant}$$

where

f = frequency in megacycles

d = cathode-to-anode distance in centimeters

V = anode voltage in volts.

Transit-time effect appears when ϕ becomes greater than 1. Spacing between electrodes of u-h-f tubes then must be small, and operation at high voltage is necessary. In addition cathodes must be designed for high current density operation.

2. Positive-grid tubes: Utilize an oscillating space charge produced by acceleration of electrons through the positive grid toward a negative reflecting anode. This principle has been used for generating waves down to lengths of one centimeter. Low power output and low efficiency have hitherto limited their wide application.

3. Velocity-modulated tubes: Utilize, the acceleration and retarding action of an alternating electron voltage on an electron beam to vary the velocity in the beam. After passage of the beam through a field-free drift space, the beam arrives with variations of space-charge density. In passing through the opening of a resonant cavity at this point, the variation of the beam density induces a current in the external circuit. Several types of amplifiers and oscillators employ this principle of operation; some, such as the reflex Klystron, have a single cavity. While a theoretical efficiency of about 50 percent may thereby be achieved, the actual efficiency in the frequency range around 10 centimeters is only a few percent.

4. Magnetrons: May be considered as another form of velocity-modulated tube in which the electron stream instead of being accelerated linearly is

Ultra-high-frequency tubes *continued*

given a circular trajectory by means of a transverse magnetic field. Energy from this beam is not lost directly to an acceleration electrode at d-c potential as in the linear case and accordingly a higher operating efficiency may be obtained. Usually acceleration and retardation of the rotary beam is accomplished by one or more pairs of electrodes associated with one or more resonant circuits.

Wavelengths down to a centimeter are produced by the so-called *first order* ($n = 1$) oscillations generated in a magnetron having a single pair of plates. Relatively low efficiency and power output are obtained in this mode of operation. Design formulas relating dimensions, d-c anode voltage, magnetic field strength, and output frequency for this case are obtained from the basic relation for electron angular velocity

$$\omega_m = H \frac{e}{m}$$

$$\lambda = \frac{10,700}{H}$$

$$E_b = 0.022 r_b^2 \left[1 - \left(\frac{r_k}{r_b} \right)^2 \right]^2 H^2$$

where

H = field intensity in gauss

E_b = d-c accelerating voltage in volts

λ = generated wavelength in centimeters

r_b = anode radius in centimeters

r_k = cathode radius in centimeters

Higher order oscillations of the magnetron may be obtained at high outputs and efficiencies exceeding that of the linear velocity-modulated tubes.

Cathode-ray tubes**Electrodes***

Control electrode (modulating electrode, grid, or grid No. 1): Is operated at a negative potential with respect to the cathode in conventional cathode-ray tubes. The negative potential controls the beam current and, therefore, the trace brightness.

* Sections on Electrodes, Characteristics, and Application Notes prepared by I. E. Lempert, Allen B. Dumont Laboratories, Inc.

Cathode-ray tubes *continued*

Screen grid (grid No. 2): Is not utilized in all cathode-ray tube designs. Its introduction makes the control characteristic independent of the accelerating potential when operated at fixed positive potential. In electrostatic focus, it makes the screen current (beam current to fluorescent screen) substantially independent of the focusing electrode voltage over the focus region. In some tube designs, it is used to change the control characteristic dynamically by application of varying potential.

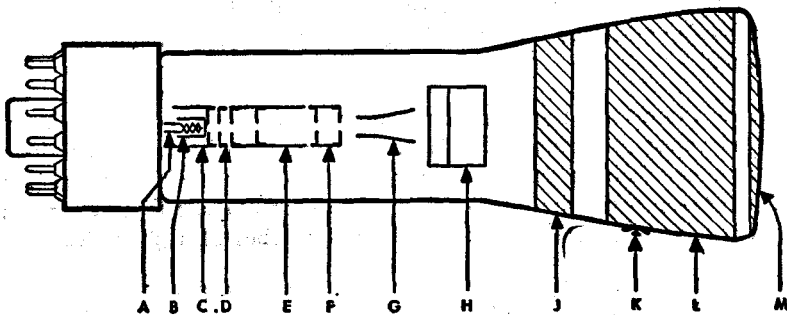

Fig. 3—Electrode arrangement of typical electrostatic focus and deflection cathode-ray tube. A heater. B cathode. C control electrode. D screen grid or pre-accelerator. E focusing electrode. F accelerating electrode. G deflection plate pair. H deflection yoke. J conductive coating connected to accelerating electrode. K intensifier electrode terminal. L intensifier electrode (conductive coating on glass). M fluorescent screen.

Focusing electrode (anode No. 1): Is used in electrostatic-focus cathode-ray tubes and operates at a positive potential,* adjustable to focus the spot.

Accelerating electrode (anode No. 2 or anode): In usual usage, the second anode is the last electrode, prior to deflection, which produces acceleration. The second anode potential is the potential of the electron beam in the deflection region.

Intensifier electrode (post-accelerating electrode, anode No. 3): Provides acceleration after deflection.

Preaccelerating electrode: In common usage, is an electrode like a screen grid or second grid, but connected to the accelerating electrode internally. It makes the screen current (beam current to fluorescent screen) substantially independent of the focusing electrode voltage over the focus region.

Deflection plates (deflection electrodes): Conventional cathode-ray tubes have two pairs of deflection plates at right angles to each other. The electric field between the plates of a pair causes deflection of the beam and, therefore, displacement of spot, in a direction perpendicular to plates of a pair.

* All potentials are with respect to the cathode except when otherwise indicated.

Characteristics

Cutoff voltage (E_{co}): Negative grid potential at which screen current becomes zero (as indicated by visual extinction of a focused undeflected spot), or some specified low value. It varies directly with the accelerating electrode potential except in tubes with independently connected screen grids where it varies approximately as the screen-grid potential, the accelerating electrode potential having a second order effect (E_{co} increases slightly with accelerating electrode potential). E_{co} is independent of intensifier electrode potential.

Control characteristic (modulation characteristic): Is a curve of beam current versus grid potential. It is often expressed in terms of grid drive (grid potential above cutoff) rather than actual grid potential. This method of expressing it has the advantage that the characteristic then varies less with accelerating potential and with individual tubes of a given design.

Focusing voltage: In electrostatic focus tubes, the focusing electrode voltage at which the spot comes to a focus varies directly with accelerating electrode voltage in most tube designs and is substantially independent of the intensifier electrode potential.

Focusing current or focusing ampere turns: Applies to magnetic-focus cathode-ray tubes and is usually expressed in terms of a definite focus coil in a definite location on the tube. While more than one value of current will focus, the best focus is obtained with the minimum value, i.e., the one ordinarily specified. The focusing current (or ampere turns) increases with accelerating potential.

Deflection factor (for electrostatic-deflection tubes): Is defined as the voltage required between a pair of deflection plates to produce unit deflection of the spot, and is usually expressed in d-c volts per inch of displacement. It varies directly with the accelerating potential in intensifier-type tubes so long as the ratio of the intensifier potential to accelerating-electrode potential (all potentials with respect to cathode) is constant. The application of twice the accelerating electrode potential to the intensifier electrode increases the deflection factor 15 percent to 30 percent above the value with the accelerating electrode and intensifier electrode at the same potential, depending on the tube design.

Deflection factor (for magnetic deflection tubes): Usually expressed in terms of a definite deflection yoke in a definite location on the tube, in amperes or milliamperes per inch of spot deflection, it varies as the square root of the accelerating electrode potential.

Cathode-ray tubes *continued*

Deflection sensitivity: Is the reciprocal of the deflection factor. Usually, however, it is expressed in millimeters per volt for electrostatic deflection tubes.

Spot size: Must be expressed in terms of a defined method of measurement since spot edges are not usually sharp. When the accelerating potential is varied and the screen current maintained constant, the spot size usually decreases with increasing accelerating potential. If the brightness is held constant while varying the accelerating potential, the spot size decreases even more with increasing accelerating potential.

Brightness: Increases with beam current and with accelerating potential. At constant screen current, it usually increases with accelerating potential at a rate between the first and second power of the accelerating potential, approaching a maximum depending upon the screen material.

Application notes

Grid voltage: To permit variation of brightness over the entire range, the grid voltage, should be variable from the maximum specified cutoff bias of a cathode-ray tube to zero. Allowance should be made for a-c grid voltages if they are applied, and for potential drops which may occur in d-c grid-return circuits due to allowable grid leakage.

Focusing electrode voltage source (electrostatic-focus tubes): Bleeder design should be such as to cover the range of focus voltage over which tubes are permitted to vary by specifications, both at the value of focusing-electrode current that may be encountered in operation, and at cutoff (zero focusing-electrode current).

Deflection-plate potentials (electrostatic-deflection tubes): To avoid defocusing of the spot, the instantaneous average potential of the plates of each deflection-plate pair should always be the same as that of the accelerating electrode.

Magnetic shielding: Magnetic shielding is necessary if it is desired to eliminate magnetic effects on the beam. The earth's and other magnetic fields may shift the beam considerably.

Approximate formulas

Electrostatic deflection: Is proportional to deflection voltage, inversely proportional to accelerating voltage, and at right angles to the plane of the plates and toward the more positive plate. For deflection electrode structures using straight parallel deflection plates

Cathode-ray tubes *continued*

$$D = \frac{E_d L^2}{2E_a A}$$

D = deflection

E_d = deflection voltage

E_a = accelerating voltage

A = separation of plates

l = length of plates

L = length from center of plates to screen

D, A, l, L are all in the same units

Electromagnetic deflection: Is proportional to flux or current in coil, inversely proportional to the square root of the accelerating voltage, and at right angles to the direction of the field

$$D = \frac{0.3LH}{\sqrt{E_a}}$$

D = deflection in centimeters

L = length in centimeters between screen and point where beam enters deflecting field

I = length of deflection field in centimeters

H = flux density in gauss

E_a = accelerating voltage

NI = deflecting coil ampere turns

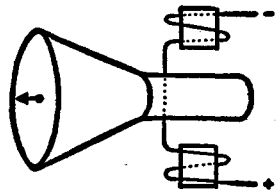

Deflection sensitivity: Is linear up to frequency where phase of deflecting voltage begins to reverse before electron has reached end of deflecting field. Beyond this frequency, sensitivity drops off reaching zero and then passing through a series of maxima and minima as $n = 1, 2, 3 \dots$. Each succeeding maximum is of smaller magnitude

$$D_{zero} = n\lambda \left(\frac{v}{c} \right)$$

$$D_{max} = (2n - 1) \left(\frac{\lambda}{2} \right) \left(\frac{v}{c} \right)$$

D = deflection

v = electron velocity

c = speed of light (3×10^{10} cm/sec)

Electron velocity: For accelerating voltages up to 10,000

$$v \text{ (km per sec)} = 593\sqrt{E_a}$$

Cathode-ray tubes *continued*

Beyond 10,000 volts, apply Einstein's correction for the increase in mass of the electron.

Earth's magnetic field:

Maximum 0.4 gauss horizontal (Philippine Islands)

0.6 gauss vertical (Canada)

City of New York 0.17 gauss horizontal; 0.59 gauss vertical

Magnetic focusing: There is more than one value of current that will focus. Best focus is at minimum value.

For an average coil

$$IN = 220 \sqrt{\frac{V_0 d}{f}}$$

IN = ampere turns

V_0 = kv accelerating voltage

d = mean diameter of coil

f = focal length

d and f are in the same units

A well-designed, shielded coil will require fewer ampere turns.

Example of good shield design

$$X = \frac{d_1}{20}$$

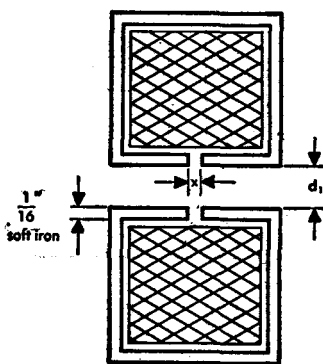

Army-Navy preferred list of electron tubes

142

1 November 1945

Receiving

filament voltage	diodes	diode triodes	triodes	twin triodes	pentodes		converters	Klystrons	power output	tuning indicators	rectifiers	miscellaneous	
					remote	sharp						cathode ray	crystals
1.4	1A3	1S5†	11E3	3A5	1T4	1L4 11N5 1S5†	11C6 1R5		3A4 3Q4 3S4			2AP1A 3DP1A 3J1 3J7 5CP1A 5CP7A 5FP7A 5FP14 5J1 7BP7A 12DP7A	1N21B 1N23B 1N25 1N26 1N31 1N32
5.0											5U4G 5Y3GT/G		
6.3	2B22 6AL5 6H6*	6AQ6 6SQ7* 6SR7*	2C22 2C40 6C4 6F4† 6I4 6I5* 9002	6J6 6SL7W 6SN7W 7F8	6AB7 6SG7* 6SK7* 9003	6AC7W 6AG7 6AK5 6AN5 6AS6 6SH7* 6SJ7* 7W7 9001	6SA7*	2K22 2K25 2K26 2K27 2K28 2K29 2K41 2K45 726A 726B 726C	6AK6 6AR6 6AS7G 6B4G 6L6WGA 6N7GT/G 6V6GT/G 6Y6G	6AF6G 6E5	6X5GT/G 1005		phototubes 1P21 925 1P30 926 1P35 929 920 931A 921 935 922
12.6	12H6*	12SQ7* 12SR7*	12J5GT	12SL7GT 12SN7GT	12SG7* 12SK7*	12SH7 12SJ7* 14W7	12SA7*						voltage regulators 0A2 0B2 0C2 0A3/VR75 0C3/VR105 0D3/VR150 991
25 or over									25L6GT/G 35L6GT/G		25Z6GT/G		
Only types for 28 volts anode supply operation		26C6				6AJ5 26A6	26D6		26A5 26A7GT 28D7				

Transmitting

	triodes	tetrodes	twin tetrodes	pentodes	pulse modulation	magnetrons	vacuum	rectifiers		clipper tubes	gas switching		
								gas	grid control		ATR	TR	
2C26A	811	807	815	2E22	3D21A	2J30-34	4J31-35	1Z2	3B28	2D21	3B26	1B35	1B23
2C39	826	813	829B	2E25	3C45	2J41	4J36-42	2X2A	4B26	C5B	4B31	1B37	1B24
2C43	862A	814	832A	4E27	3E29	2J42	4J43-44	3B24W	4B35	6D4	719A	1B44	1B27
3C28	880	827R†		803	4C35	2J48	4J50	5R4GY	5B21	393A		1B51	1B32
CV92(Br)†	889R-A	1625		837	5C22	2J49	4J51	371B	6C	394A		1B52	1B50
100TH	1626				6C21	2J50	4J52	836	83	884		1B53	1B55
250TH	8025A				715C†	2J51	5J26	1616	857B	2050		1B56	1B58
304TH						2J53	5J29	8016	866A			1B57	
450TH						2J55-56	5J30	8020	869B				
527						2J58	5J31		872A				
						2J60	5J32		1C06				
						2J61A-62A						pre-TR modulators	
												1B38	1B22
												1B54	1B41 1B42

* Where direct interchangeability with prototype listed above is assured and its JAN-1A Specification has been issued a counterpart of the prototype indicated by suffix letter(s) GT, GT/G, Y, W, A, B, etc. may be used.

† Consultation with applicable service laboratory's electron tube group is recommended before application in equipment.

‡ Diode Pentode.

■ Vacuum tube amplifiers

Classification

It is common practice to differentiate between types of vacuum tube circuits, particularly amplifiers, on the basis of the operating regime of the tube.

Class A: Grid bias and alternating grid voltages such that plate current flows continuously throughout electrical cycle ($\theta_p = 360^\circ$).

Class AB: Grid bias and alternating grid voltages such that plate current flows appreciably more than half but less than entire electrical cycle ($360^\circ > \theta_p > 180^\circ$).

Class B: Grid bias close to cut-off such that plate current flows only during approximately half of electrical cycle ($\theta_p \cong 180^\circ$).

Class C: Grid bias appreciably greater than cut-off so that plate current flows for appreciably less than half of electrical cycle ($\theta_p < 180^\circ$).

A further classification between circuits in which positive grid current is conducted during some portion of the cycle, and those in which it is not, is denoted by subscripts 2 and 1, respectively. Thus a class AB₂ amplifier operates with a positive swing of the alternating grid voltage such that positive electronic current is conducted, and accordingly in-phase power is required to drive the tube.

General design

For quickly estimating the performance of a tube from catalog data, or for predicting the characteristics needed for a given application, the ratios given in Table I may be used.

Table I—Typical amplifier operating data

Maximum signal conditions—per tube

function	class A	class B a-f (p-p)	class B r-f	class C r-f
Plate efficiency η %	20-30	35-65	60-70	65-85
Peak instantaneous to d-c plate current ratio M_{ib}/I_b	1.5-2	3.1	3.1	3.1-4.5
RMS alternating to d-c plate current ratio I_p/I_b	0.5-0.7	1.1	1.1	1.1-1.2
RMS alternating to d-c plate voltage ratio E_p/E_b	0.3-0.5	0.5-0.6	0.5-0.6	0.5-0.6
D-C to peak instantaneous grid current I_e/M_{ie}		0.25-0.1	0.25-0.1	0.15-0.1

General design *continued*

Table I gives correlating data for typical operation of tubes in the various amplifier classifications. From this table, knowing the maximum ratings of a tube, the maximum power output, currents, voltages, and corresponding load impedance may be estimated. Thus, taking for example, a type F-124-A water-cooled transmitting tube as a class C radio-frequency power amplifier and oscillator—the constant-current characteristics of which are shown in Fig. 1—published maximum ratings are as follows:

D-C plate voltage	$E_b = 20,000$ volts
D-C grid voltage	$E_c = 3,000$ volts
D-C plate current	$I_b = 7$ amperes
R-F grid current	$I_g = 50$ amperes
Plate input	$P_i = 135,000$ watts
Plate dissipation	$P_p = 40,000$ watts

Maximum conditions may be estimated as follows:

$$\text{For } \eta = 75\% \quad P_i = 135,000 \text{ watts} \quad E_b = 20,000 \text{ volts}$$

$$\text{Power output } P_0 = \eta P_i = 100,000 \text{ watts}$$

$$\text{Average d-c plate current } I_b = P_i/E_b = 6.7 \text{ amperes}$$

From tabulated typical ratio $M_{i_b}/I_b = 4$, instantaneous peak plate current $M_{i_b} = 4I_b = 27$ amperes

The rms alternating plate current component, taking ratio $I_p/I_b = 1.2$, $I_p = 1.2 I_b = 8$ amperes

The rms value of the alternating plate voltage component from the ratio $E_p/E_b = 0.6$ is $E_p = 0.6 E_b = 12,000$ volts.

The approximate operating load resistance r_L is now found from

$$r_L = \frac{E_p}{I_p} = 1500 \text{ ohms.}$$

An estimate of the grid drive power required may be obtained by reference to the constant current characteristics of the tube and determination of the peak instantaneous positive grid current M_{i_c} and the corresponding instantaneous total grid voltage M_{e_c} . Taking the value of grid bias E_c for the given operating condition, the peak a-c grid drive voltage is

$$M_{E_g} = (M_{e_c} - E_c)$$

from which the peak instantaneous grid drive power

$$M_{P_g} = M_{E_g} M_{i_c}$$

General design *continued*

An approximation to the average grid drive power P_g , necessarily rough due to neglect of negative grid current, is obtained from the typical ratio

$$\frac{I_c}{M_i I_c} = 0.2$$

of d-c to peak value of grid current, giving

$$P_g = I_c E_g = 0.2 M_i E_g \text{ watts.}$$

Plate dissipation P_p may be checked with published values since

$$P_p = P_i - P_o.$$

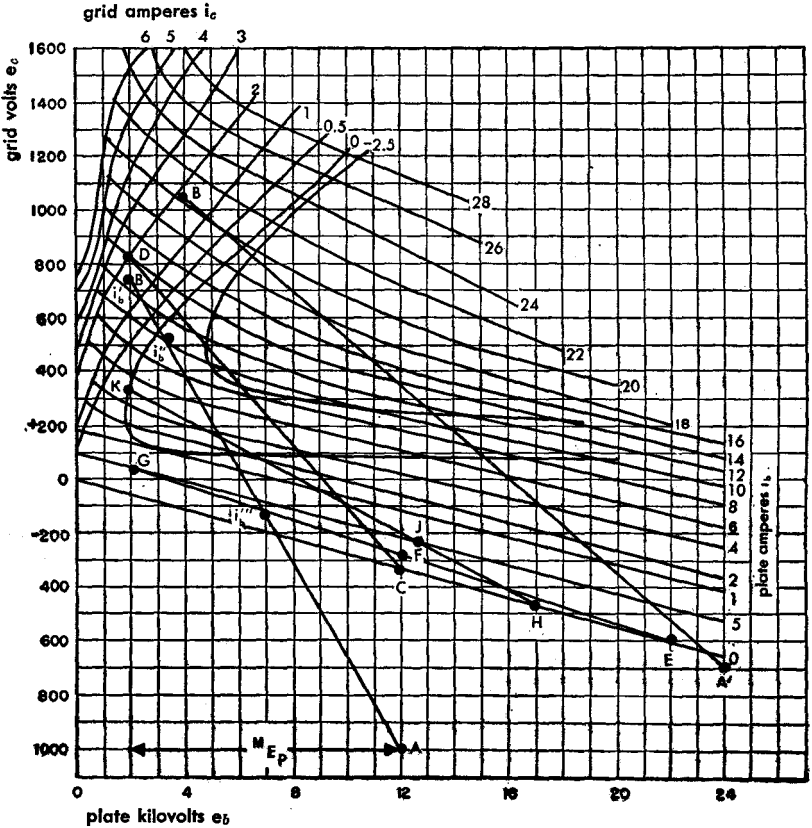

Fig. 1—Constant-current characteristics with typical load lines: AB—class C, CD—class B, EFG—class A, and HJK—class AB.

General design *continued*

It should be borne in mind that combinations of published maximum ratings as well as each individual maximum rating must be observed. Thus, for example in this case, the maximum d-c plate operating voltage of 20,000 volts does not permit operation at the maximum d-c plate current of 7 amperes since this exceeds the maximum plate input rating of 135,000 watts.

Plate load resistance r_l may be connected directly in the tube plate circuit, as in the resistance-coupled amplifier, through impedance-matching elements as in audio-frequency transformer coupling, or effectively represented by a loaded parallel resonant circuit as in most radio-frequency amplifiers. In any case, calculated values apply only to effectively resistive loads, such as are normally closely approximated in radio-frequency amplifiers. With appreciably reactive loads, operating currents and voltages will in general be quite different and their precise calculation is quite difficult.

The physical load resistance present in any given set-up may be measured by audio-frequency or radio-frequency bridge methods. In many cases, the proper value of r_l is ascertained experimentally as in radio-frequency amplifiers which are tuned to the proper minimum d-c plate current. Conversely, if the circuit is to be matched to the tube, r_l is determined directly as in a resistance-coupled amplifier or as

$$r_l = N^2 r_s$$

in the case of a transformer-coupled stage, where N is the primary-to-secondary output voltage transformation ratio. In a parallel-resonant circuit in which the output resistance r_s is connected directly in one of the resistance legs,

$$r_l = \frac{X^2}{r_s} = \frac{L}{Cr_s} = QX,$$

where X is the leg reactance at resonance (ohms).

L and C are leg inductance (henries) and capacitance (farads), respectively,

$$Q = \frac{X}{r_s}$$

Graphical design methods

When accurate operating data are required, more precise methods must be used. Because of the non-linear nature of tube characteristics, graphical methods usually are most convenient and rapid. Examples of such methods are given below.

A comparison of the operating regimes of class A, AB, B, and C amplifiers is given in the constant-current characteristics graph of Fig. 1. The

Graphical design methods *continued*

lines corresponding to the different classes of operation are each the locus of instantaneous grid e_c and plate e_b voltages, corresponding to their respective load impedances.

For radio-frequency amplifiers and oscillators having tuned circuits giving an effective resistive load, plate and grid tube and load alternating voltages are sinusoidal and in phase (disregarding transit time), and the loci become straight lines.

For amplifiers having non-resonant resistive loads, the loci are in general non-linear except in the distortionless case of linear tube characteristics (constant r_p) for which they are again straight lines.

Thus, for determination of radio-frequency performance, the constant-current chart is convenient. For solution of audio-frequency problems, however, it is more convenient to use the ($i_b - e_c$) transfer characteristics of Fig. 2 on which a dynamic load line may be constructed.

Methods for calculation of the most important cases are given below.

Class C r-f amplifier or oscillator

Draw straight line from A to B (Fig. 1) corresponding to chosen d-c operating plate and grid voltages, and to desired peak alternating plate and grid voltage excursions. The projection of AB on the horizontal axis thus corresponds to ${}^M E_p$. Using Chaffee's 11-point method of harmonic analysis, lay out on AB points:

$$e'_p = {}^M E_p \quad e''_p = 0.866 {}^M E_p \quad e'''_p = 0.5 {}^M E_p$$

to each of which correspond instantaneous plate currents i'_b, i''_b and i'''_b and instantaneous grid currents i'_c, i''_c and i'''_c . The operating currents are obtained from the following expressions:

$$I_b = \frac{1}{12} [i'_b + 2i''_b + 2i'''_b] \quad I_c = \frac{1}{12} [i'_c + 2i''_c + 2i'''_c]$$

$${}^M I_p = \frac{1}{6} [i'_b + 1.73i''_b + i'''_b] \quad {}^M I_g = \frac{1}{6} [i'_c + 1.73i''_c + i'''_c].$$

Substitution of the above in the following give the desired operating data.

$$\text{Power output } P_o = \frac{{}^M E_p {}^M I_p}{2}$$

$$\text{Power input } P_i = E_b I_b$$

$$\text{Average grid excitation power} = \frac{{}^M E_g {}^M I_g}{2}$$

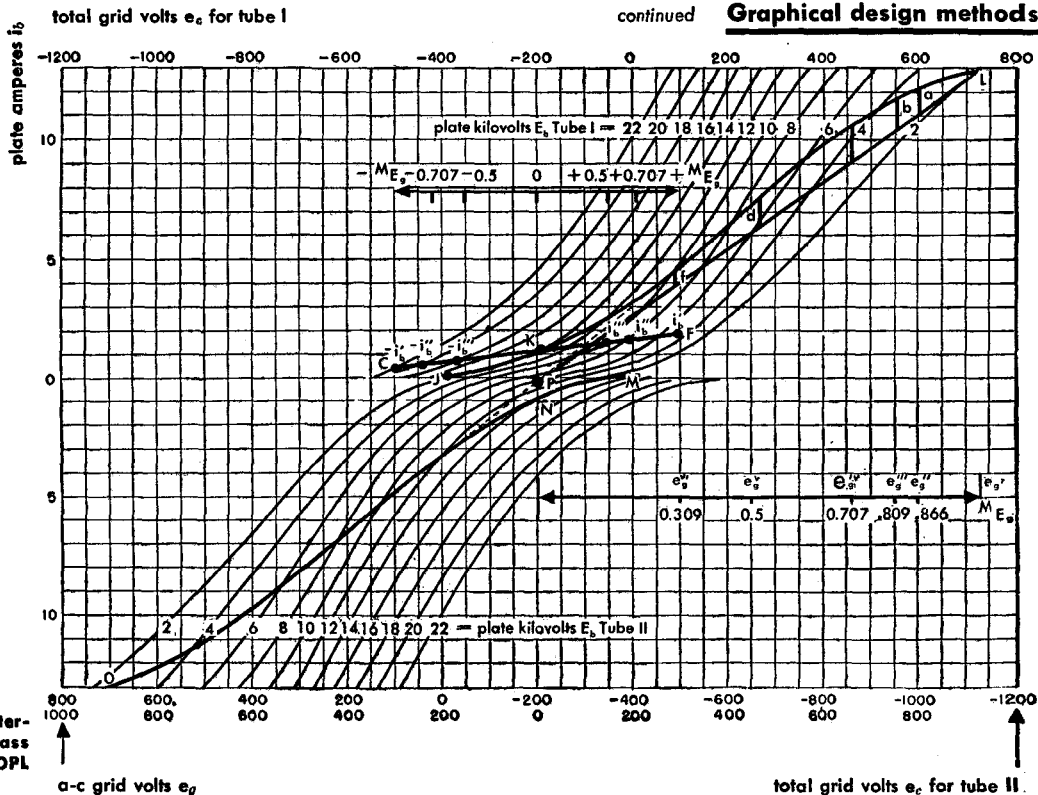

Fig. 2—Transfer characteristics i_b versus e_b with class A_2 —CKF and class B—OPL load lines.

Graphical design methods *continued*

Peak grid excitation power = ${}^M E_g i'_c$

Plate load resistance $r_l = \frac{{}^M E_p}{{}^M I_p}$

Grid bias resistance $R_c = \frac{E_c}{I_c}$

Plate efficiency $\eta = \frac{P_o}{P_i}$

Plate dissipation $P_p = P_i - P_o$

The above procedure may also be applied to plate-modulated class C amplifiers. Taking the above data as applying to carrier conditions, the analysis is repeated for $E_b^{\text{crest}} = 2E_b$ and $P_o^{\text{crest}} = 4P_o$ keeping r_l constant. After a cut-and-try method has given a peak solution, it will often be found that combination fixed and self grid biasing as well as grid modulation is indicated to obtain linear operation.

To illustrate the preceding exposition, a typical amplifier calculation is given below:

Operating requirements (carrier condition)

$E_b = 12,000$ volts $P_o = 25,000$ watts $\eta = 75\%$

Preliminary calculation (refer to Table II)

Table II—Class C r-f amplifier data 100% plate modulation

symbol	preliminary	detailed	
	carrier	carrier	crest
E_b (volts)	12,000	12,000	24,000
${}^M E_p$ (volts)	10,000	10,000	20,000
E_c (volts)		-1,000	-700
${}^M E_g$ (volts)		1,740	1,740
I_b (amp)	2.9	2.8	6.4
${}^M I_p$ (amp)	4.9	5.1	10.2
I_c (amp)		0.125	0.083
${}^M I_g$ (amp)		0.255	0.183
P_i (watts)	35,000	33,600	154,000
P_o (watts)	25,000	25,500	102,000
P_p (watts)		220	160
η (percent)	75	76	66
r_l (ohms)	2,060	1,960	1,960
R_c (ohms)		7,100	7,100
E_{cc} (volts)		-110	-110

Graphical design methods *continued*

$$\frac{E_p}{E_b} = 0.6$$

$$E_p = 0.6 \times 12,000 = 7200 \text{ volts}$$

$${}^M E_p = 1.41 \times 7200 = 10,000 \text{ volts}$$

$$I_p = \frac{P_o}{E_p}$$

$$I_p = \frac{25,000}{7200} = 3.48 \text{ amperes}$$

$${}^M I_p = 4.9 \text{ amperes}$$

$$\frac{I_p}{I_b} = 1.2$$

$$I_b = \frac{3.48}{1.2} = 2.9 \text{ amperes}$$

$$P_i = 12,000 \times 2.9 = 35,000 \text{ watts}$$

$$\frac{{}^M i_b}{I_b} = 4.5$$

$${}^M i_b = 4.5 \times 2.9 = 13.0 \text{ amperes}$$

$$r_l = \frac{E_p}{I_p} = \frac{7200}{3.48} = 2060 \text{ ohms}$$

Complete calculation

Layout carrier operating line, AB on constant current graph, Fig. 1, using values of E_b , ${}^M E_p$, and ${}^M i_b$ from preliminary calculated data. Operating carrier bias voltage, E_c , is chosen somewhat greater than twice cutoff value, 1000 volts, to locate point A.

The following data are taken along AB:

$i_b' = 13 \text{ amp}$	$i_c' = 1.7 \text{ amp}$	$E_c = -1000 \text{ volts}$
$i_b'' = 10 \text{ amp}$	$i_c'' = -0.1 \text{ amp}$	$e_c' = 740 \text{ volts}$
$i_b''' = 0.3 \text{ amp}$	$i_c''' = 0 \text{ amp}$	${}^M E_p = 10,000 \text{ volts}$

From the formulas, complete carrier data as follows are calculated:

$${}^M I_p = \frac{1}{6} [13 + 1.73 \times 10 + 0.3] = 5.1 \text{ amp}$$

$$P_o = \frac{10,000 \times 5.1}{2} = 25,500 \text{ watts}$$

$$I_b = \frac{1}{12} [13 + 2 \times 10 + 2 \times 0.3] = 2.8 \text{ amp}$$

$$P_i = 12,000 \times 2.8 = 33,600 \text{ watts}$$

Graphical design methods *continued*

$$\eta = \frac{25,500}{33,600} \times 100 = 76 \text{ percent}$$

$$r_l = \frac{10,000}{5.1} = 1960 \text{ ohms}$$

$$I_c = \frac{1}{12} [1.7 + 2 (-0.1)] = 0.125 \text{ amp}$$

$$M I_o = \frac{1}{6} [1.7 + 1.7 (-0.1)] + 0.255 \text{ amp}$$

$$P_o = \frac{1740 \times 0.255}{2} = 220 \text{ watts}$$

Operating data at 100 percent positive modulation crests are now calculated knowing that here

$$E_b = 24,000 \text{ volts} \quad r_l = 1960 \text{ ohms}$$

and for undistorted operation

$$P_0 = 4 \times 25,500 = 102,000 \text{ watts} \quad M E_p = 20,000 \text{ volts}$$

The crest operating line A'B' is now located by trial so as to satisfy the above conditions, using the same formulas and method as for the carrier condition.

It is seen that in order to obtain full-crest power output, in addition to doubling the alternating plate voltage, the peak plate current must be increased. This is accomplished by reducing the crest bias voltage with resultant increase of current conduction period, but lower plate efficiency.

The effect of grid secondary emission to lower the crest grid current is taken advantage of to obtain the reduced grid-resistance voltage drop required. By use of combination fixed and grid resistance bias proper variation of the total bias is obtained. The value of grid resistance required is given by

$$R_c = \frac{-[E_c - \text{crest} E_c]}{I_c - \text{crest} I_c}$$

and the value of fixed bias by

$$E_{cc} = E_c - (I_c R_c)$$

Calculations at carrier and positive crest together with the condition of zero output at negative crest give sufficiently complete data for most purposes. If accurate calculation of audio-frequency harmonic distortion is necessary the above method may be applied to the additional points required.

Class B r-f amplifiers

A rapid approximate method is to determine by inspection from the tube ($i_b - e_b$) characteristics the instantaneous current, i'_b and voltage e'_b , corresponding to peak alternating voltage swing from operating voltage E_b .

$$\text{A-C plate current } {}^M I_p = \frac{i'_b}{2}$$

$$\text{D-C plate current } I_b = \frac{i'_b}{\pi}$$

$$\text{A-C plate voltage } {}^M E_p = E_b - e'_b$$

$$\text{Power output } P_0 = \frac{(E_b - e'_b) i'_b}{4}$$

$$\text{Power input } P_i = \frac{E_b i'_b}{\pi}$$

$$\text{Plate efficiency } \eta = \frac{\pi}{4} \left(1 - \frac{e'_b}{E_b} \right)$$

Thus $\eta \cong 0.6$ for the usual crest value of ${}^M E_p \cong 0.8 E_b$.

The same method of analysis used for the class C amplifier may also be used in this case. The carrier and crest condition calculations, however, are now made from the same E_b , the carrier condition corresponding to an alternating-voltage amplitude of $\frac{{}^M E_p}{2}$ such as to give the desired carrier power output.

For greater accuracy than the simple check of carrier and crest conditions, the radio-frequency plate currents ${}^M I'_{p1}$, ${}^M I''_{p1}$, ${}^M I'''_{p1}$, ${}^M I^o_{p1} - {}^M I'''_{p1}$, $- {}^M I''_{p1}$, and $- {}^M I'_{p1}$ may be calculated for seven corresponding selected points of the audio-frequency modulation envelope $+ {}^M E_g$, $+ 0.707 {}^M E_g$, $+ 0.5 {}^M E_g$, 0 , $- 0.5 {}^M E_g$, $- 0.707 {}^M E_g$, and $- {}^M E_g$, where the negative signs denote values in the negative half of the modulation cycle. Designating

$$S' = {}^M I'_{p1} + (- {}^M I'_{p1})$$

$$D' = {}^M I'_{p1} - (- {}^M I'_{p1}), \text{ etc.,}$$

the fundamental and harmonic components of the output audio-frequency current are obtained as

$${}^M I_{p1} = \frac{S'}{4} + \frac{S''}{2\sqrt{2}} \text{ (fundamental)}$$

$${}^M I_{p2} = \frac{5D'}{24} + \frac{D''}{4} - \frac{D'''}{3}$$

Graphical design methods *continued*

$$M_{I_{p3}} = \frac{S'}{6} - \frac{S'''}{3}$$

$$M_{I_{p5}} = \frac{S'}{12} - \frac{S''}{2\sqrt{2}} + \frac{S'''}{3}$$

$$M_{I_{p4a}} = \frac{D'}{8} - \frac{D''}{4}$$

$$M_{I_{p6}} = \frac{D'}{24} - \frac{D''}{4} + \frac{D'''}{3}$$

This detailed method of calculation of audio-frequency harmonic distortion may, of course, also be applied to calculation of the class C modulated amplifier, as well as to the class A modulated amplifier.

Class A and AB a-f amplifiers

Approximate formulas assuming linear tube characteristics:

Maximum undistorted power output $M P_0 = \frac{M E_p M I_p}{2}$

when plate load resistance $r_l = r_p \left[\frac{E_c}{\frac{M E_p}{\mu} - E_c} - 1 \right]$

and

Negative grid bias $E_c = \frac{M E_p}{\mu} \left(\frac{r_l + r_p}{r_l + 2r_p} \right)$

giving

Maximum plate efficiency $\eta = \frac{M E_p M I_p}{8 E_b I_b}$

Maximum maximum undistorted power output $MM P_0 = \frac{M E_p^2}{16 r_p}$

when

$$r_l = 2 r_p \quad E_c = \frac{3}{4} \frac{M E_p}{\mu}$$

An exact analysis may be obtained by use of a dynamic load line laid out on the transfer characteristics of the tube. Such a line is CKF of Fig. 2 which is constructed about operating point K for a given load resistance r_l from the following relation:

$$i_b^S = \frac{e_b^R - e_b^S}{r_l} + i_b^R$$

where

R, S, etc., are successive conveniently spaced construction points.

Graphical design methods *continued*

Using the seven-point method of harmonic analysis, plot instantaneous plate currents i'_b , i''_b , i'''_b , i_b , $-i'''_b$, $-i''_b$, and $-i'_b$ corresponding to $+M E_g$, $+0.707M E_g$, $+0.5M E_g$, 0 , $-0.5M E_g$, $-0.707M E_g$, and $-M E_g$, where 0 corresponds to the operating point K . In addition to the formulas given under class B radio-frequency amplifiers:

$$I_b \text{ average} = I_b + \frac{D'}{8} + \frac{D''}{4}$$

from which complete data may be calculated.

Class AB and B a-f amplifiers

Approximate formulas assuming linear tube characteristics give (referring to Fig. 1, line CD) for a class B audio-frequency amplifier:

$$M I_p = i'_b$$

$$P_0 = \frac{M E_p M I_p}{2}$$

$$P_i = \frac{2}{\pi} E_b M I_p$$

$$\eta = \frac{\pi}{4} \frac{M E_p}{E_b}$$

$$R_{pp} = 4 \frac{M E_p}{i'_b} = 4 r_l$$

Again an exact solution may be derived by use of the dynamic load line JKL on the $(i_b - e_c)$ characteristic of Fig. 2. This line is calculated about the operating point K for the given r_l (in the same way as for the class A case). However, since two tubes operate in phase opposition in this case, an identical dynamic load line MNO represents the other half cycle, laid out about the operating bias abscissa point but in the opposite direction (see Fig. 2).

Algebraic addition of instantaneous current values of the two tubes at each value of e_c gives the composite dynamic characteristic for the two tubes OPL. Inasmuch as this curve is symmetrical about point P it may be analyzed for harmonics along a single half curve PL by the Mouromtseff 5-point method. A straight line is drawn from P to L and ordinate plate current differences a , b , c , d , f between this line and curve, corresponding to e''_g , e'''_g , e^{IV}_g , e^V_g , and e^{VI}_g , are measured. Ordinate distances measured upward from curve PL are taken positive.

Graphical design methods *continued*

Fundamental and harmonic current amplitudes and power are found from the following formulas:

$$M_{I_{p1}} = i'_b - M_{I_{p3}} + M_{I_{p5}} - M_{I_{p7}} + M_{I_{p9}} - M_{I_{p11}}$$

$$M_{I_{p3}} = 0.4475 (b + f) + \frac{d}{3} - 0.578 d - \frac{1}{2} M_{I_{p5}}$$

$$M_{I_{p5}} = 0.4 (a - f)$$

$$M_{I_{p7}} = 0.4475 (b + f) - M_{I_{p3}} + 0.5 M_{I_{p5}}$$

$$M_{I_{p9}} = M_{I_{p3}} - \frac{2}{3} d$$

$$M_{I_{p11}} = 0.707c - M_{I_{p3}} + M_{I_{p5}}$$

Even harmonics are not present due to dynamic characteristic symmetry. The direct current and power input values are found by the 7-point analysis from curve PL and doubled for two tubes.

Classification of amplifier circuits

The classification of amplifiers in classes A, B, and C is based on the operating conditions of the tube.

Another classification can be used, based on the type of circuits associated with the tube.

A tube can be considered as a four-terminal network with two input terminals and two output terminals. One of the input terminals and one of the output terminals are usually common; this common junction or point is usually called "ground".

When the common point is connected to the filament or cathode of the tube, we can speak of a grounded-cathode circuit. It is the most conventional type of vacuum tube circuit. When the common point is the grid, we can speak of a grounded-grid circuit, and when the common point is the plate or anode, we can speak of the grounded-anode circuit.

This last type of circuit is most commonly known by the name of *cathode follower*.

A fourth and most general class of circuit is obtained when the common point or ground is not directly connected to any of the three electrodes of the tube. This is the condition encountered at u-h-f where the series impedances of the internal tube leads make it impossible to ground any of them. It is also encountered in such special types of circuits as the *phase-splitter*, in which the impedance from plate to ground and the impedance from cathode to ground are made equal in order to obtain an output between plate and cathode balanced with respect to ground.

Table III—Classification of triode amplifier circuits

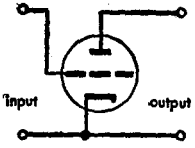
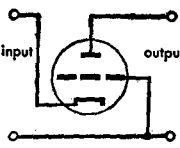
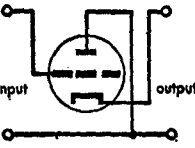
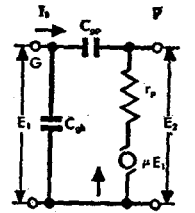
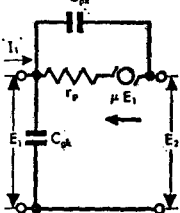
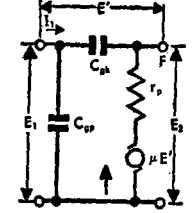
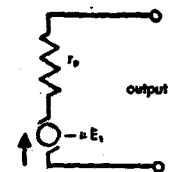
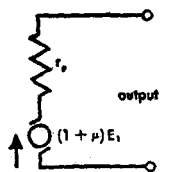
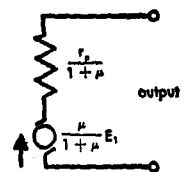
circuit classification	grounded-cathode	grounded-grid	grounded-plate or cathode follower
Circuit schematic			
Equivalent circuit, a-c component, class A operation			
Voltage gain, γ for output load impedance = Z_2	<p>neglecting C_{gp}</p> $\gamma = \frac{-\mu Z_2}{r_p + Z_2}$ $= -g_m \frac{r_p Z_2}{r_p + Z_2}$ <p>(Z_2 includes C_{pk})</p>	<p>neglecting C_{pk}</p> $\gamma = (1 + \mu) \frac{Z_2}{r_p + Z_2}$ <p>(Z_2 includes C_{gp})</p>	<p>neglecting C_g</p> $\gamma = \frac{\mu Z_2}{r_p + (1 + \mu) Z_2}$ <p>(Z_2 includes C_{pk})</p>
Input admittance	$Y_1 = j\omega [C_{gk} + (1 - \gamma) C_{gp}]$	$Y_1 = j\omega [C_{gk} + (1 - \gamma) C_{pk}] + \frac{1 + \mu}{r_p + Z_2}$	$Y_1 = j\omega [C_{gp} + (1 - \gamma) C_{gk}]$
Equivalent generator seen by load at output terminals	<p>neglecting C_{gp}</p> 	<p>neglecting C_{pk}</p> 	<p>neglecting C_{pk}</p> 

Classification of amplifier circuits *continued*

Design information for the first three classifications is given in Table III, where

Z_2 = load impedance to which output terminals of amplifier are connected

E_1 = rms driving voltage across input terminals of amplifier

E_2 = rms output voltage across load impedance Z_2

I_1 = rms current at input terminals of amplifier

γ = voltage gain of amplifier = $\frac{E_2}{E_1}$

Y_1 = input admittance to input terminals of amplifier = $\frac{I_1}{E_1}$

$\omega = 2\pi \times$ frequency of excitation voltage E_1

$j = \sqrt{-1}$

and the remaining notation is in accordance with the nomenclature of pages 127 and 128.

Cathode follower data

General characteristics

1. High impedance input, low impedance output.
2. Input and output have one side grounded.
3. Good wide-band frequency and phase response.
4. Output is in phase with input.
5. Voltage gain or transfer is always less than one.
6. A power gain can be obtained.
7. Input capacitance is reduced.

General case

Transfer = $\frac{g_m R_L}{g_m R_L + 1}$ or $g_m Z_r$

Z_r = resultant cathode to ground impedance = R_{out} in parallel with R_e

R_{out} = output resistance

= $\frac{R_p}{\mu + 1}$ or approximately $\frac{1}{g_m}$

R_L = total load resistance

Input capacitance = $C_{gp} + \frac{C_{ok}}{1 + g_m R_L}$

g_m = transconductance in mhos (1000 micromhos = 0.001 mhos)

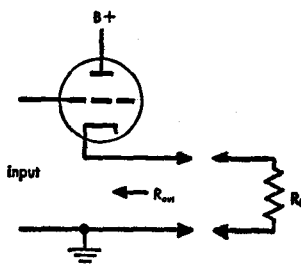

Cathode follower data *continued***Specific cases**

1. To match the characteristic impedance of the transmission line, R_{out} must equal Z_0 . The transfer is approximately 0.5.

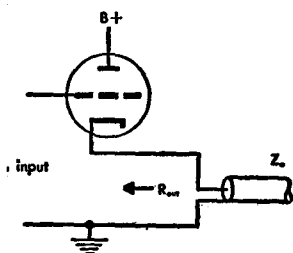

2. If R_{out} is less than Z_0 , add resistor R_c' in series so that $R_c' = Z_0 - R_{out}$. The transfer is approximately 0.5.

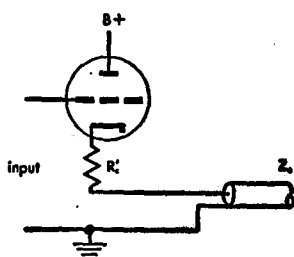

3. If R_{out} is greater than Z_0 add resistor R_c in parallel so that

$$R_c = \frac{Z_0 R_{out}}{R_{out} - Z_0}$$

$$\text{Transfer} = \frac{g_m Z_0}{2}$$

Note: Normal operating bias must be provided.

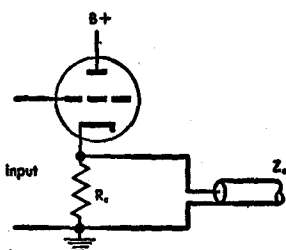

For coupling a high impedance into a low impedance transmission line, for maximum transfer choose a tube with a high g_m .

Resistance-coupled audio amplifier design

Stage gain at

$$\text{Medium frequencies} = A_m = \frac{\mu R}{R + R_p}$$

$$\text{High frequencies} = A_h = \frac{A_m}{\sqrt{1 + \omega^2 C_1^2 r^2}}$$

$$\text{Low frequencies*} = A_l = \frac{A_m}{\sqrt{1 + \frac{1}{\omega^2 C_2^2 \rho^2}}}$$

*The low-frequency stage gain also is affected by the values of the cathode by-pass capacitor and the screen by-pass capacitor.

Resistance coupled audio amplifier design *continued*

where

$$R = \frac{r_l R_2}{r_l + R_2}$$

$$r = \frac{R r_p}{R + r_p}$$

$$\rho = R_2 + \frac{r_l r_p}{r_l + r_p}$$

μ = amplification factor of tube

$\omega = 2\pi \times$ frequency

r_l = plate load resistance in ohms

R_2 = grid leak resistance in ohms

r_p = a-c plate resistance in ohms

C_1 = total shunt capacitance in farads

C_2 = coupling capacitance in farads

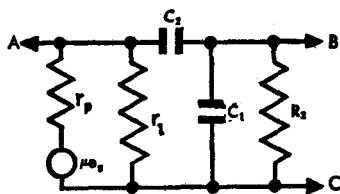

A—plate.
B—grid.
C—ground or cathode.

Given $C_1, C_2, R_2,$ and X = fractional response required

At highest frequency

$$r = \frac{\sqrt{1 - X^2}}{\omega C_1 X} \quad R = \frac{r r_p}{r_p - r} \quad r_l = \frac{R R_2}{R_2 - R}$$

At lowest frequency*

$$C_2 = \frac{X}{\omega \rho \sqrt{1 - X^2}}$$

* The low-frequency stage gain also is affected by the values of the cathode by-pass capacitor and the screen by-pass capacitor.

Negative feedback

The following quantities are functions of frequency with respect to magnitude and phase:

$E, N,$ and D = signal, noise, and distortion output voltage with feedback
 $e, n,$ and d = signal, noise, and distortion output voltage without feedback

- A = voltage amplification of amplifier at a given frequency
- β = fraction of output voltage fed back; for usual negative feedback, β is negative
- ϕ = phase shift of amplifier and feedback circuit at a given frequency

Reduction in gain caused by feedback

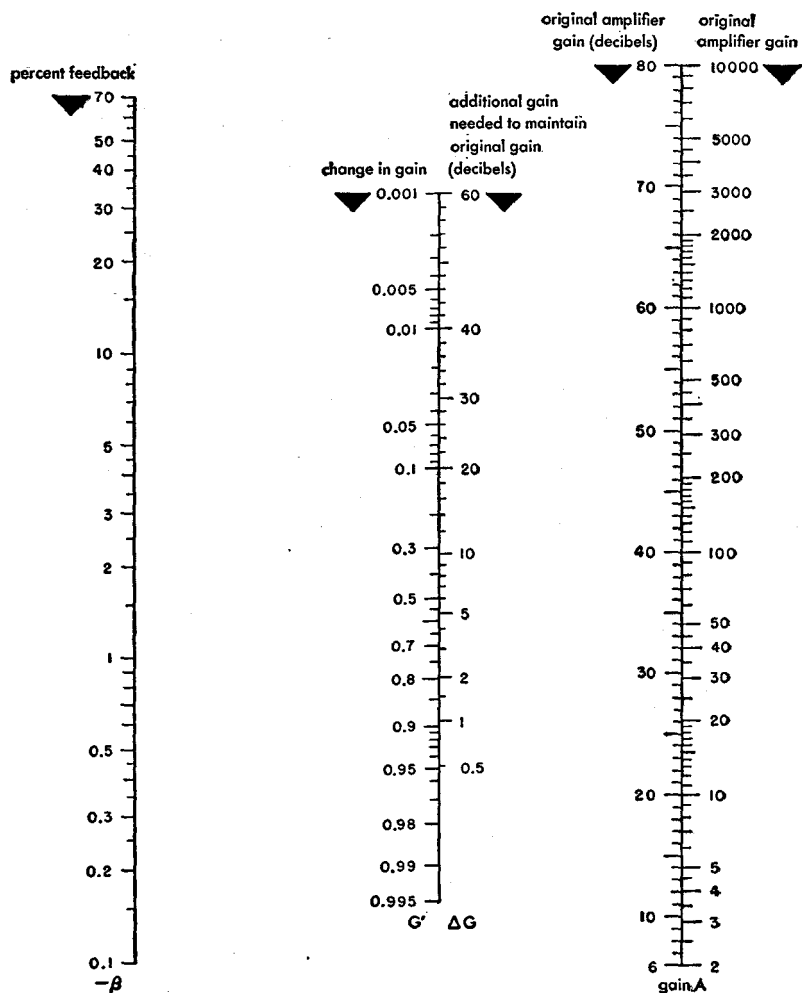
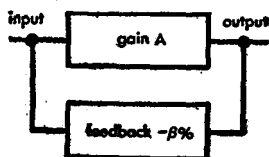

Fig. 3—In negative-feedback amplifier considerations β , expressed as a percentage, has a negative value. A line across the β and A scales intersects the center scale to indicate change in gain. It also indicates the amount, in decibels, the input must be increased to maintain original output.



Negative feedback *continued*

The total output voltage with feedback is

$$E + N + D = e + \frac{n}{1 - A\beta} + \frac{d}{1 - A\beta} \quad (1)$$

It is assumed that the input signal to the amplifier is increased when negative feedback is applied, keeping $E = e$.

$(1 - A\beta)$ is a measure of the amount of feedback. By definition, the amount of feedback expressed in decibels is

$$20 \log_{10} |1 - A\beta| \quad (2)$$

$$\text{Voltage gain with feedback} = \frac{A}{1 - A\beta} \quad (3)$$

$$\text{and change of gain} = \frac{1}{1 - A\beta} \quad (4)$$

If the amount of feedback is large, i.e., $-A\beta \gg 1$, the voltage gain becomes $-\frac{1}{\beta}$ and so is independent of A . (5)

In the general case when ϕ is not restricted to 0 or π

$$\text{the voltage gain} = \frac{A}{\sqrt{1 + |A\beta|^2 - 2|A\beta| \cos \phi}} \quad (6)$$

$$\text{and change of gain} = \frac{1}{\sqrt{1 + |A\beta|^2 - 2|A\beta| \cos \phi}} \quad (7)$$

Hence if $|A\beta| \gg 1$, the expression is substantially independent of ϕ .

On the polar diagram relating $(A\beta)$ and ϕ (Nyquist diagram), the system is unstable if the point $(1, 0)$ is enclosed by the curve.

Feedback amplifier with single beam power tube

The use of the foregoing negative feedback formulas is illustrated by the amplifier circuit shown in Fig. 4.

The amplifier consists of an output stage using a 6V6-G beam power tetrode with feedback driven by a resistance-coupled stage using a 6J7-G in a pentode connection. Except for resistors R_1 and R_2 which supply the feedback voltage, the circuit constants and tube characteristics are taken from published data.

Negative feedback *continued*

The fraction of the output voltage to be fed back is determined by specifying that the total harmonic distortion is not to exceed 4 percent. The plate supply voltage is taken as 250 volts. At this voltage, the 6V6-G has 8 percent

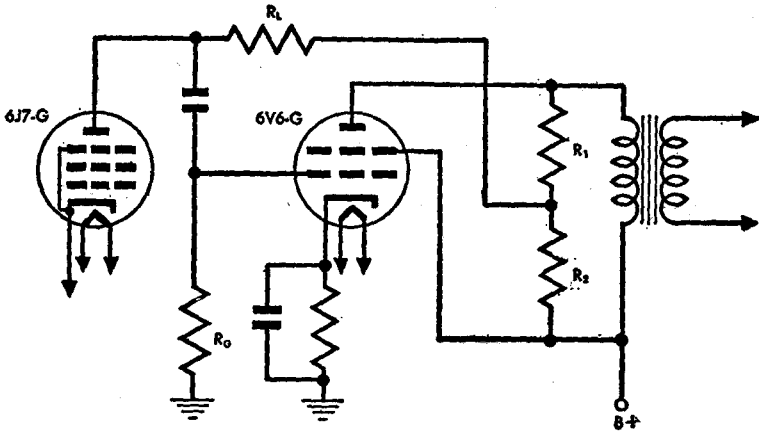

Fig. 4—Feedback amplifier with single beam power tube.

total harmonic distortion. From equation (1), it is seen that the distortion output voltage with feedback is

$$D = \frac{d}{1 - A\beta}$$

This may be written as

$$1 - A\beta = \frac{d}{D}$$

where

$$\frac{d}{D} = \frac{8}{4} = 2 \quad 1 - A\beta = 2 \quad \beta = -\frac{1}{A}$$

and where A = the voltage amplification of the amplifier without feedback.

The peak a-f voltage output of the 6V6-G under the assumed conditions is

$$E_o = \sqrt{4.5 \times 5000 \times 2} = 212 \text{ volts}$$

This voltage is obtained with a peak a-f grid voltage of 12.5 volts so that the voltage gain of this stage without feedback is

$$A = \frac{212}{12.5} = 17$$

Negative feedback *continued*

Hence $\beta = -\frac{1}{A} = -\frac{1}{17} = -0.0589$ or 5.9% approximately

The voltage gain of the output stage with feedback is computed from equation (3) as follows

$$A' = \frac{A}{1 - A\beta} = \frac{17}{2} = 8.5$$

and the change of gain due to feedback by equation (4) thus

$$\frac{1}{1 - A\beta} = 0.5$$

The required amount of feedback voltage is obtained by choosing suitable values for R_1 and R_2 . The feedback voltage on the grid of the 6V6-G is reduced by the effect of R_g , R_L and the plate resistance of the 6J7-G. The effective grid resistance is

$$R_g' = \frac{R_g r_p}{R_g + r_p}$$

where $R_g = 0.5$ megohm.

This is the maximum allowable resistance in the grid circuit of the 6V6-G with cathode bias.

$r_p = 4$ megohms, the plate resistance of the 6J7-G tube

$$R_g' = \frac{4 \times 0.5}{4 + 0.5} = 0.445 \text{ megohm}$$

The fraction of the feedback voltage across R_2 which appears at the grid of the 6V6-G is

$$\frac{R_g'}{R_g' + R_L} = \frac{0.445}{0.445 + 0.25} = 0.64$$

where $R_L = 0.25$ megohm.

Thus the voltage across R_2 to give the required feedback must be

$$\frac{5.9}{0.64} = 9.2\% \text{ of the output voltage.}$$

This voltage will be obtained if $R_1 = 50,000$ ohms and $R_2 = 5000$ ohms.

This resistance combination gives a feedback voltage ratio of

$$\frac{5000 \times 100}{50,000 + 5000} = 9.1\% \text{ of the output voltage.}$$

Negative feedback *continued*

In a transformer-coupled output stage, the effect of phase shift on the gain with feedback does not become appreciable until a noticeable decrease in gain without feedback also occurs. In the high-frequency range, a phase shift of 25 degrees lagging is accompanied by a 10 percent decrease in gain. For this frequency, the gain with feedback is computed from equation (6).

$$A' = \frac{A}{\sqrt{1 + |A\beta|^2 - 2|A\beta|\cos\phi}}$$

where $A = 15.3$, $\phi = 180^\circ$, $\cos\phi = 0.906$, $\beta = 0.059$.

$$A' = \frac{15.3}{\sqrt{1 + |0.9|^2 + 2|0.9|0.906}} = \frac{15.3}{\sqrt{3.44}} = \frac{15.3}{1.85} = 8.27$$

The change of gain with feedback is computed from equation (7).

$$\frac{1}{\sqrt{1 + |A\beta|^2 - 2|A\beta|\cos\phi}} = \frac{1}{1.85} = 0.541$$

If this gain with feedback is compared with the value of 8.5 for the case of no phase shift, it is seen that the effect of frequency on the gain is only 2.7 percent with feedback compared to 10 percent without feedback.

The change of gain with feedback is 0.541 times the gain without feedback whereas in the frequency range, where there is no phase shift, the corresponding value is 0.5. This quantity is 0.511 when there is phase shift but no decrease of gain without feedback.

Distortion

A rapid indication of the harmonic content of an alternating source is given by the *distortion factor* which is expressed as a percentage.

$$\text{Distortion factor} = \sqrt{\frac{\text{sum of squares of amplitudes of harmonics}}{\text{square of amplitude of fundamental}}} \times 100\%$$

If this factor is reasonably small, say less than 10 percent, the error involved in measuring it

$$\sqrt{\frac{\text{sum of squares of amplitudes of harmonics}}{\text{sum of squares of amplitudes of fundamental and harmonics}}} \times 100\%$$

is also small. This latter is measured by the *distortion factor meter*.

■ Room acoustics*

General considerations for good room acoustics

The following information is intended primarily to aid field engineers in appraising acoustical properties of existing structures and not as a complete treatise on the subject.

Good acoustics—governing factors

a. Reverberation time or amount of reverberation: Varies with frequency and is measured by the time required for a sound, when suddenly interrupted, to die away or decay to a level 60 decibels (db) below the original sound.

The reverberation time and the shape of the reverberation-time/frequency curve can be controlled by selecting the proper amounts and varieties of sound-absorbent materials and by the methods of application. Room occupants must be considered inasmuch as each person present contributes a fairly definite amount of sound absorption.

b. Standing sound waves: Resonant conditions in sound studios cause standing waves by reflections from opposing parallel surfaces, such as ceiling-floor and parallel walls, resulting in serious peaks in the reverberation-time/frequency curve. Standing sound waves in a room can be considered comparable to standing electrical waves in an improperly terminated transmission line where the transmitted power is not fully absorbed by the load.

Room sizes and proportions for good acoustics

The frequency of standing waves is dependent on room sizes: frequency decreases with increase of distances between walls and between floor and ceiling. In rooms with two equal dimensions, the two sets of standing waves occur at the same frequency with resultant increase of reverberation time at resonant frequency. In a room with walls and ceilings of cubical contour this effect is tripled and elimination of standing waves is practically impossible.

The most advantageous ratio for height: width: length is in the proportion of $1:2^{2/3} : 2^{3/3}$ or separated by $1/3$ or $2/3$ of an octave.

In properly proportioned rooms, resonant conditions can be effectively reduced and standing waves practically eliminated by introducing numerous surfaces disposed obliquely. Thus, large-order reflections can be avoided by breaking them up into numerous smaller reflections. The object is to pre-

* Compiled by Edward J. Content, consulting engineer.

Room sizes and proportions for good acoustics *continued*

vent sound reflection back to the point of origin until after several reflections.

Most desirable ratios of dimensions for broadcast studios are given in Fig. 1.

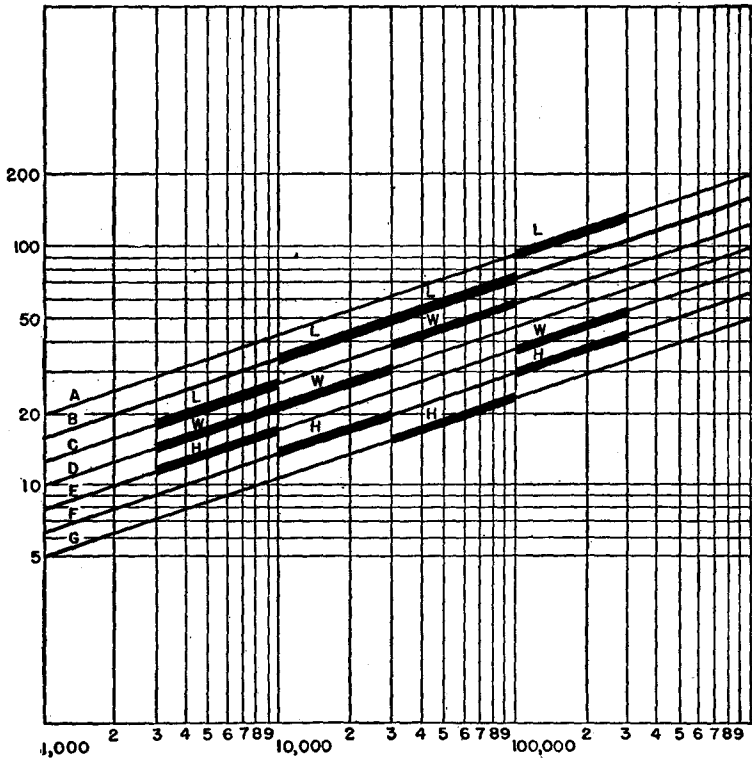

Courtesy of Acoustical Society of America and RCA

volume in cubic feet
 dimensions in feet

type room	H:W:L	chart designation
Small	1:1.25:1.6	E:D:C:
Average shape	1:1.60:2.5	F:D:B:
Low ceiling	1:2.50:3.2	G:C:B:
Long	1:1.25:3.2	F:E:A:

Fig. 1—Preferred room dimensions based on 2¹ ratio. Permissible deviation ± 5 percent.

Optimum reverberation time

Optimum, or most desirable reverberation time, varies with (1) room size, and (2) use, such as music, speech, etc. (see Figs. 2 and 3).

Optimum reverberation time *continued*

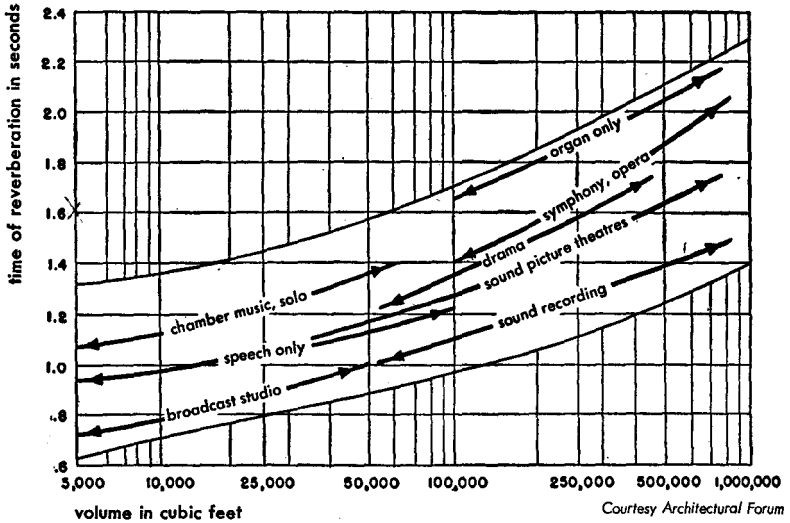

Fig. 2—Optimum reverberation time in seconds for various room volumes at 512 cycles per second.

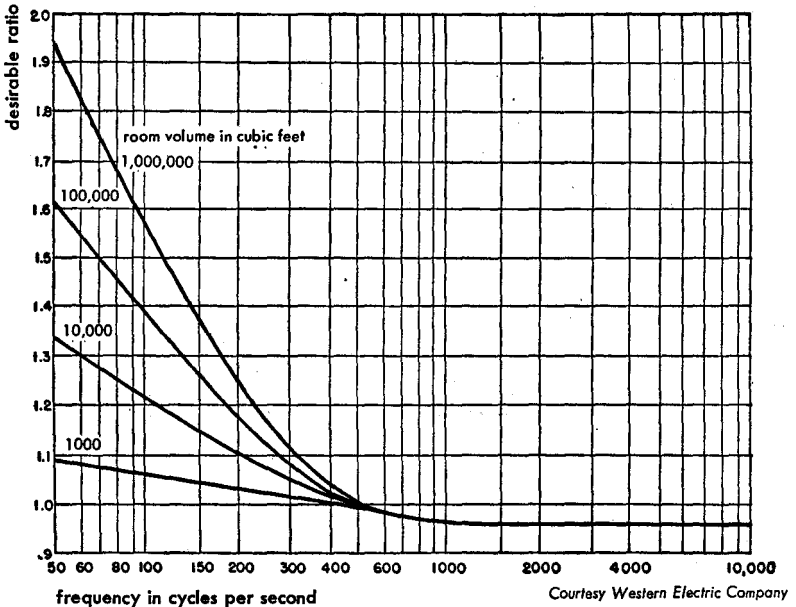

Fig. 3—Desirable relative reverberation time versus frequency for various structures and auditoriums.

Note: These curves show the desirable ratio of the reverberation time for various frequencies to the reverberation time for 512 cycles. The desirable reverberation time for any frequency between 60 and 8000 cycles may be found by multiplying the reverberation time at 512 cycles (from Fig. 2) by the number in the vertical scale which corresponds to the frequency chosen.

Optimum reverberation time continued

A small radio studio for speech broadcasts represents a special case. The acoustic studio design should be such that the studio neither adds nor detracts from the speaker's voice, which on reproduction in the home should sound as though he were actually present.

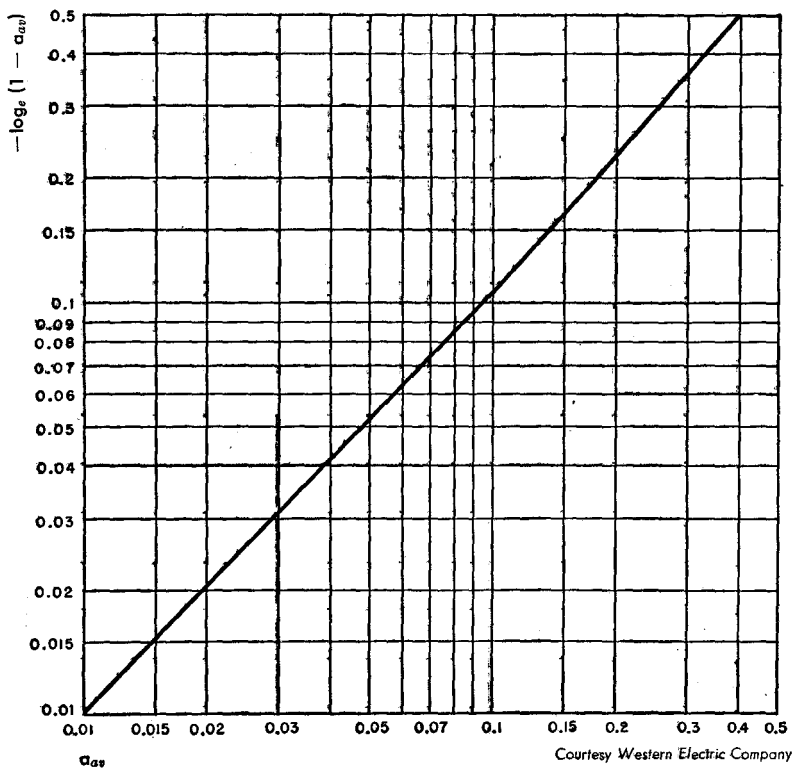

Fig. 4.

For optimum characteristics of a speech studio, the reverberation time should be about one-half a second throughout the middle and lower audio-frequency range. At high frequencies, the reverberation time may be 20 percent to 25 percent greater than at 512 cycles. This rise at the higher frequencies enhances intelligibility and allows for the presence in the studio of one or two extra persons without materially affecting the reverberation-time/frequency curve.

Optimum reverberation time *continued*

Speech sounds above about 1000 cycles promote intelligibility. Apparent intensity of speech sounds is provided by frequencies below this value.

Preponderance of low bass reverberation and standing waves tends to make the voice sound "boomy" and impairs speech intelligibility.

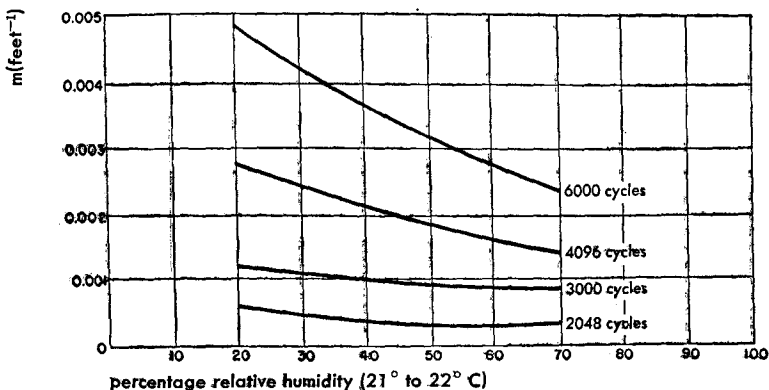

Fig. 5—Value of attenuation constant m at different frequencies and relative humidities.*

Computation of reverberation time

Reverberation time at different audio frequencies may be computed from room dimensions and average absorption. Each portion of the surface of a room has a certain absorption coefficient α dependent on the material of the surface, its method of application, etc. This absorption coefficient is equal to the ratio of the energy absorbed by the surface to the total energy impinging thereon at various audio frequencies. Total absorption for a given surface area in square feet S is expressed in terms of absorption units, the number of units being equal to $a_{av}S$.

$$a_{av} = \frac{\text{total number of absorption units}}{\text{total surface in square feet}}$$

One absorption unit provides the same amount of sound absorption as one square foot of open window. Absorption units are sometimes referred to as "open window" or "OW" units.

$$T = \frac{0.05V}{-S \log_e(1 - a_{av})}$$

where T = reverberation time in seconds, V = room volume in cubic feet, S = total surface of room in square feet, a_{av} = average absorption coefficient of room at frequency under consideration.

* Reprinted by permission from *Architectural Acoustics* by V. O. Knudsen, published by John Wiley and Sons, Inc.

Computation of reverberation time continued

For absorption coefficients α of some typical building materials, see Table I. As an aid in using the formula for reverberation time, Fig. 4 (page 168) may be used for obtaining $[-\log_e (1 - \alpha_{av})]$ from known values of α_{av} .

Table II shows absorption coefficients for some of the more commonly used materials for acoustical correction.

Table I—Acoustical coefficients of materials and persons*

description	sound absorption coefficients cycles per second						authority
	128	256	512	1024	2048	4096	
Brick wall unpainted	0.024	0.025	0.031	0.042	0.049	0.07	W. C. Sabine
Brick wall painted	0.012	0.013	0.017	0.02	0.023	0.025	W. C. Sabine
Plaster + finish coat							
Wood lath—wood studs	0.020	0.022	0.032	0.039	0.039	0.028	P. E. Sabine
Plaster + finish coat on metal lath	0.038	0.049	0.060	0.085	0.043	0.056	V. O. Knudsen
Poured concrete unpainted	0.010	0.012	0.016	0.019	0.023	0.035	V. O. Knudsen
Poured concrete painted and varnished	0.009	0.011	0.014	0.016	0.017	0.018	V. O. Knudsen
Carpet, pile on concrete	0.09	0.08	0.21	0.26	0.27	0.37	Building Research Station
Carpet, pile on $\frac{3}{8}$ " felt	0.11	0.14	0.37	0.43	0.27	0.25	Building Research Station
Draperies, velour, 18 oz per sq yd in contact with wall	0.05	0.12	0.35	0.45	0.38	0.36	P. E. Sabine
Ozite $\frac{5}{8}$ "	0.051	0.12	0.17	0.33	0.45	0.47	P. E. Sabine
Rug, axminster	0.11	0.14	0.20	0.33	0.52	0.82	Wente and Bedell
Audience, seated per sq ft of area	0.72	0.89	0.95	0.99	1.00	1.00	W. C. Sabine
Each person, seated	1.4	2.25	3.8	5.4	6.6	—	Bureau of Standards, averages of 4 tests
Each person, seated	—	—	—	—	—	7.0	Estimated
Glass surfaces	0.05	0.04	0.03	0.025	0.022	0.02	Estimated

* Reprinted by permission from Architectural Acoustics by V. O. Knudsen, published by John Wiley and Sons, Inc.

Table II—Acoustical coefficients of materials used for acoustical correction

material	cycles per second						noise-reduction coef* *	manufactured by
	128	256	512	1024	2048	4096		
Corkoustic—B4	0.08	0.13	0.51	0.75	0.47	0.46	0.45	Armstrong Cork Co.
Corkoustic—B6	0.15	0.28	0.82	0.60	0.58	0.38	0.55	Armstrong Cork Co.
Cushiontone A-3	0.17	0.58	0.70	0.90	0.76	0.71	0.75	Armstrong Cork Co.
Koustex	0.10	0.24	0.64	0.92	0.77	0.75	0.65	David E. Kennedy, Inc.
Sanacoustic (metal) tiles	0.25	0.56	0.99	0.99	0.91	0.82	0.85	Johns-Manville Sales Corp.
Permacoustic tiles $\frac{3}{4}$ "	0.19	0.34	0.74	0.76	0.75	0.74	0.65	Johns-Manville Sales Corp.
Low-frequency element	0.66	0.60	0.50	0.50	0.35	0.20	0.50	Johns-Manville Sales Corp.
Triple-tuned element	0.66	0.61	0.80	0.74	0.79	0.75	0.75	Johns-Manville Sales Corp.
High-frequency element	0.20	0.46	0.55	0.66	0.79	0.75	0.60	Johns-Manville Sales Corp.
Absorbatone A	0.15	0.28	0.82	0.99	0.87	0.98	0.75	Luse Stevenson Co.
Acoustex 60R	0.14	0.28	0.81	0.94	0.83	0.80	0.70	National Gypsum Co.
Econacoustic 1"	0.25	0.40	0.78	0.76	0.79	0.68	0.70	National Gypsum Co.
Fiberglas acoustical tiletype TW-PF 9D	0.22	0.46	0.97	0.90	0.68	0.52	0.75	Owens-Corning Fiberglas Corp.
Acoustone D $1\frac{1}{8}$ "	0.13	0.26	0.79	0.88	0.76	0.74	0.65	U. S. Gypsum Company
Acoustone F $1\frac{1}{8}$ "	0.16	0.33	0.85	0.89	0.80	0.75	0.70	U. S. Gypsum Company
Acousti-celotex type C-6 $1\frac{1}{4}$ "	0.30	0.56	0.94	0.96	0.69	0.56	0.80	The Celotex Corp.
Absorbex type A 1"	0.41	0.71	0.96	0.88	0.85	0.96	0.85	The Celotex Corp.
Acoustee B metal facing $1\frac{1}{8}$ "	0.29	0.57	0.98	0.99	0.85	0.57	0.85	The Celotex Corp.

Courtesy Acoustics Materials Association

* The noise-reduction coefficient is the average of the coefficients at frequencies from 256 to 2048 cycles inclusive, given to the nearest 5 percent. This average coefficient is recommended for use in comparing materials for noise-quieting purposes as in offices, hospitals, banks, corridors, etc.

Computation of reverberation time *continued*

Considerable variation of sound-absorption in air at frequencies above 1000 cycles occurs at high relative humidities (see Fig. 5). Calculation of reverberation time, therefore, should be checked at average relative humidities applicable to the particular location involved. For such check calculations the following formula may be used:

$$T = \frac{0.05V}{-S \log_e (1 - a_{av}) + 4mV}$$

where m is the coefficient in feet⁻¹ as indicated in Fig. 5, page 169.

Electrical power levels for public address requirements

- a. Indoor: See Fig. 7, page 172.
b. Outdoor: See Fig. 8, page 173.

Note: Curves are for an exponential trumpet-type horn. Speech levels above reference—average 70 db, peak 80 db. For a loudspeaker of 25 percent efficiency, 4 times the power output would be required or an equivalent of 6 decibels. For one 10 percent efficiency, 10 times the power output would be required or 10 decibels.

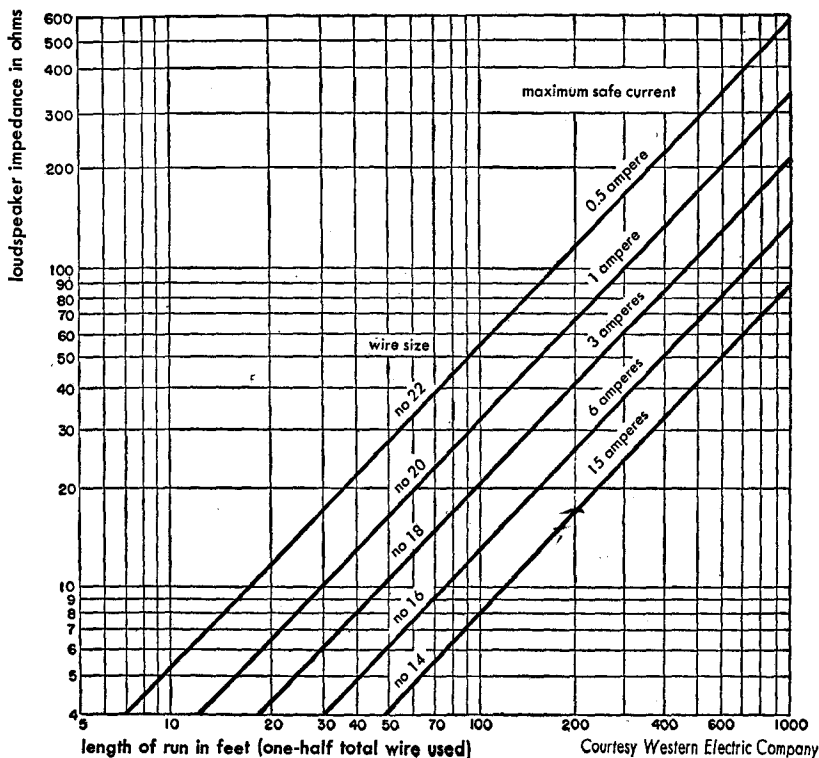

Fig. 6—Wire sizes for loudspeaker circuits assuming maximum loss of 0.5 decibel.

Electrical power levels for public address requirements continued

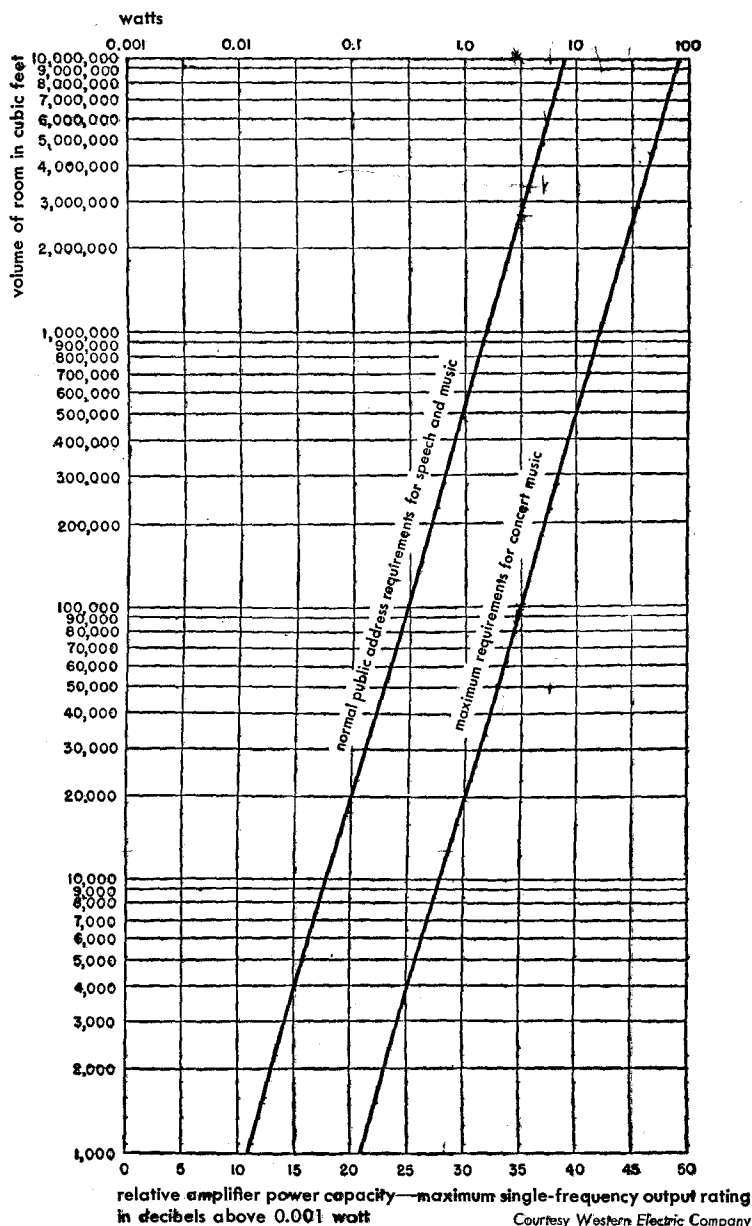

Fig. 7—Room volume and relative amplifier power capacity. To the indicated power level depending on loudspeaker efficiency, there must be added a correction factor which may vary from 4 decibels for the most efficient horn-type reproducers to 20 decibels for less efficient cone loudspeakers.

Electrical power levels for public address requirements *continued*

Fig. 8—Distance from loudspeaker and relative amplifier power capacity required for speech, average for 30° angle of coverage. For angles over 30°, more loudspeakers and proportional output power are required. Depending on loudspeaker efficiency, a correction factor must be added to the indicated power level, varying approximately from 4 to 7 decibels for the more-efficient type of horn loudspeakers.

Acoustical music ranges and levels

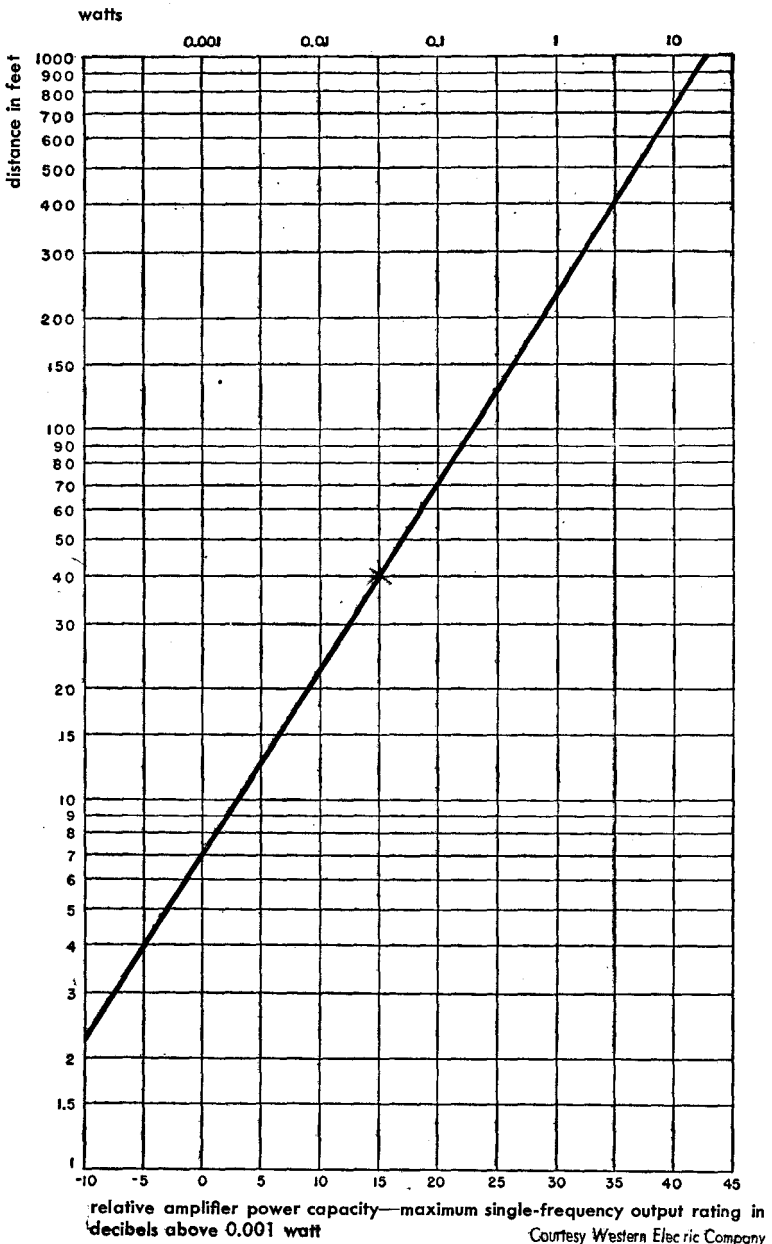
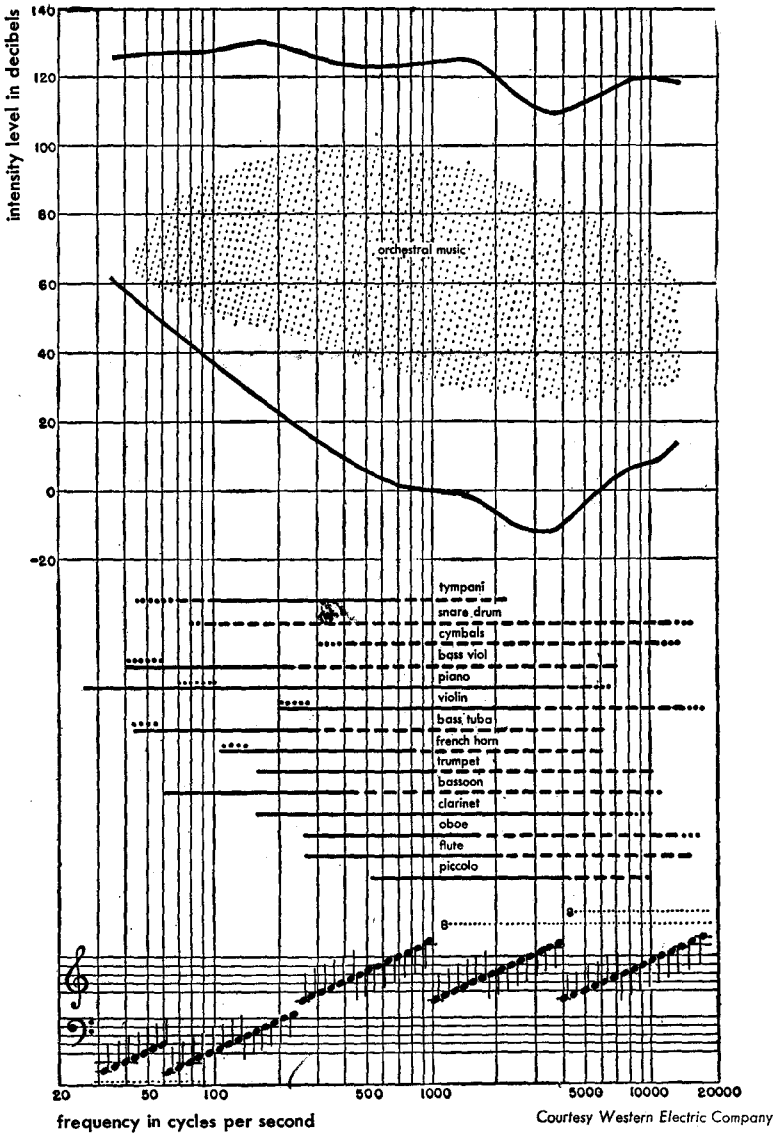

Fig. 9—Frequency ranges of musical instruments. Intensity levels of music. Zero level equals 10^{-16} watt per square centimeter.

Acoustical speech levels and ranges of other sounds

Fig. 10—Frequency ranges of male and female speech and other sounds. Intensity levels of conversational speech. Zero level equals 10^{-16} watt per square centimeter.

Acoustical sound level and pressure

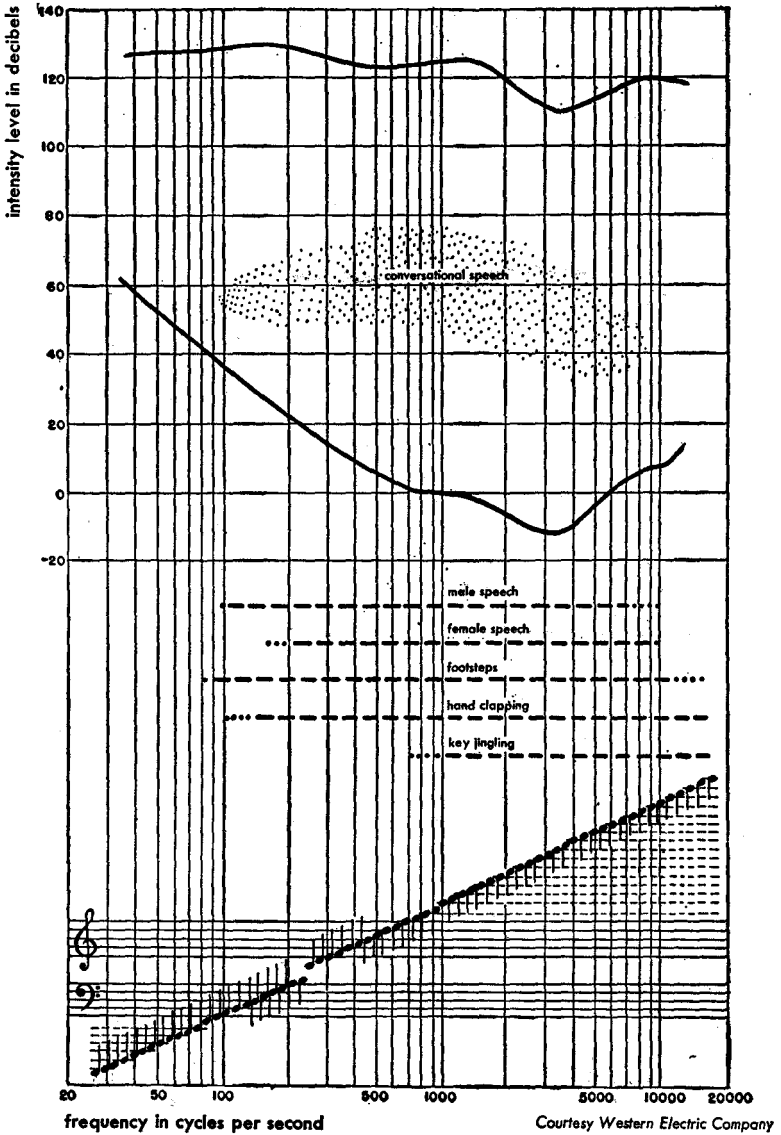
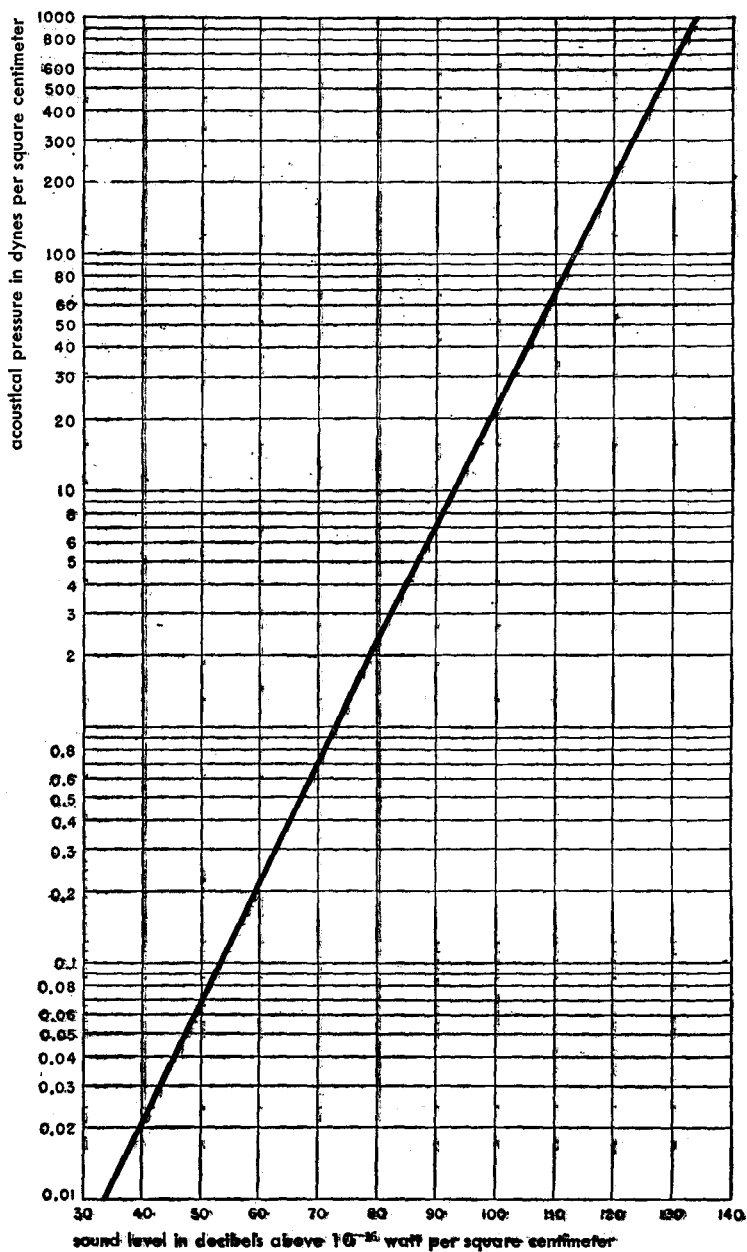

Courtesy Western Electric Company

Fig. 11—One dyne per square centimeter is equivalent to an acoustical level of plus 74 decibels.

Table III—Noise levels

noise out-of-doors	noise level in decibels	noise in building
	130	threshold of painful sound
airplane, 1600 rpm, 18 feet	120	
	110	boiler factory
riveter, 35 feet	100	subway, local station with express passing
elevated train, 15 feet	90	lion's roar, Bronx zoo house, 18 feet
noisiest spot at Niagara Falls	80	
very heavy street traffic, 15 feet	80	
average motor truck, 15 feet	70	average of 6 factory locations
average automobile, 15 feet	70	
	60	department store
quiet residential street, New York city 15 to 300 feet	60	average office
	50	
minimum street noise, midtown, New York city, 50 to 500 feet	40	quiet office average residence
	30	quietest residence measured
quiet garden, London	20	
rattle of leaves in a gentle breeze	20	quiet whisper, 5 feet
	10	
	10	threshold of hearing of street noise
reference level	0	

Zero level = 10^{-16} watt per square centimeter

Courtesy Western Electric Company

General

- Loudspeaker wire sizes: See Fig. 6, page 171.
- Acoustical musical ranges and levels: See Fig. 9, page 174.
- Acoustical speech levels and ranges of other sounds: See Fig. 10, page 175.
- Acoustical sound levels: See Fig. 11, page 176.
- Noise levels: See Table III.

General *continued*

f. Equal loudness contours: Fig. 12 gives average hearing characteristics of the human ear at audible frequencies and at loudness levels of zero to 120 db versus intensity levels expressed in decibels above 10^{-16} watt per square centimeter. Ear sensitivity varies considerably over the audible range of sound frequencies at various levels. A loudness level of 120 db is heard fairly uniformly throughout the entire audio range but, as indicated in Fig. 12,

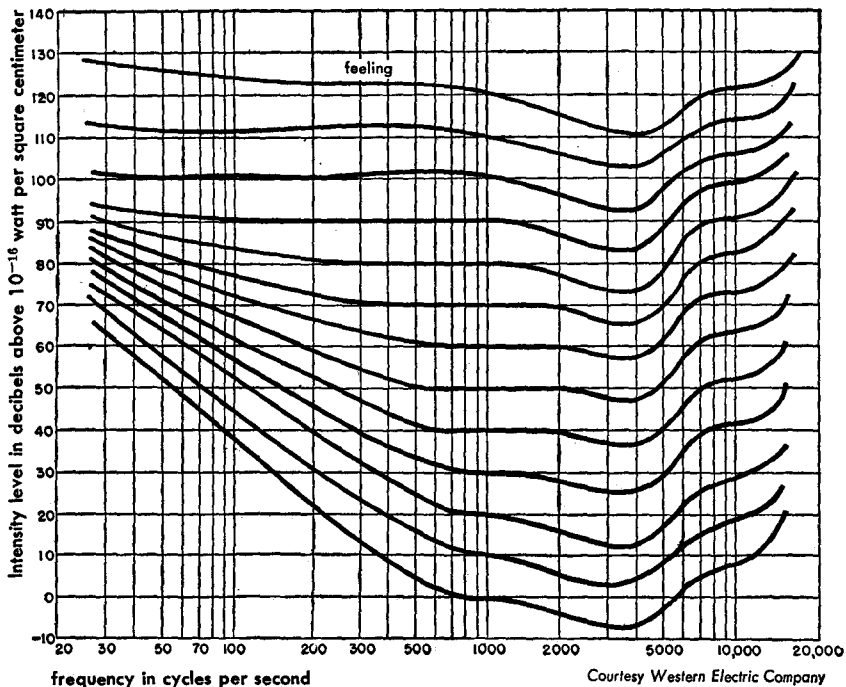

Fig. 12—Equal loudness contours.

a frequency of 1000 cycles at a 20 db level will be heard at very nearly the same intensity as a frequency of 60 cycles at a 60 db level. These curves explain why a loudspeaker operating at lower than normal level sounds as though the higher frequencies were accentuated and the lower tones seriously attenuated or entirely lacking; also, why music, speech, and other sounds, when reproduced, should have very nearly the same intensity as the original rendition. To avoid perceptible deficiency of lower tones, a symphony orchestra, for example, should be reproduced at an acoustical level during the loud passages of 90 to 100 db (see Fig. 9).

■ Wire transmission

Telephone transmission line data

Line constants of copper open-wire pairs

40 pairs DP (double petticoat) insulators per mile

12-inch spacing

temperature 68° F

frequency cycles per second	resistance ohms per loop mile			inductance millihenries per loop mile			leakance micromhos per loop mile:	
	165 mil	128 mil	104 mil	165 mil	128 mil	104 mil	dry	wet
0	4.02	6.68	10.12	3.37	3.53	3.66	0.01	2.5
500	4.04	6.70	10.13	3.37	3.53	3.66	0.15	3.0
1000	4.11	6.74	10.15	3.37	3.53	3.66	0.29	3.5
2000	4.35	6.89	10.26	3.36	3.53	3.66	0.57	4.5
3000	4.71	7.13	10.43	3.35	3.52	3.66	0.85	5.5
5000	5.56	7.83	10.94	3.34	3.52	3.66	1.4	7.5
10000	7.51	9.98	12.86	3.31	3.49	3.64	2.8	12.1
20000	10.16	13.54	17.08	3.28	3.46	3.61	5.6	20.5
30000	12.19	16.15	20.42	3.26	3.44	3.59	8.4	28.0
40000	13.90	18.34	23.14	3.26	3.43	3.58	11.2	35.0
50000	15.41	20.29	25.51	3.25	3.43	3.57	14.0	41.1
infin				3.21	3.37	3.50		

Capacitance on 40-wire lines

microfarad per loop mile

	165 mil	128 mil	104 mil
In space	0.00898	0.00855	0.00822
On 40-wire line, dry	0.00915	0.00871	0.00837
On 40-wire line, wet (approx)	0.00928	0.00886	0.00850

Line constants of copper open-wire pairs

53 pairs CS (special glass with steel pin) insulators per mile

8-inch spacing

temperature 68° F

frequency kilocycles per second	resistance ohms per loop mile			inductance millihenries per loop mile			leakance micromhos per loop mile:	
	165 mil	128 mil	104 mil	165 mil	128 mil	104 mil	dry	wet
0.0	4.02	6.68	10.12	3.11	3.27	3.40		
1.0	4.11	6.74	10.15	3.10	3.26	3.40	0.052	1.75
2.0	4.35	6.89	10.26	3.10	3.26	3.40		
3.0	4.71	7.13	10.43	3.09	3.26	3.40		
5.0	5.56	7.83	10.94	3.08	3.25	3.40	0.220	3.40
10.0	7.51	9.98	12.86	3.04	3.23	3.38	0.408	5.14
20.0	10.16	13.54	17.08	3.02	3.20	3.35	0.748	8.06
50.0	15.41	20.29	25.51	2.99	3.16	3.31	1.69	15.9
100.0	21.30	27.90	34.90	2.98	3.15	3.29	3.12	27.6
200.0	29.77	38.77	48.25	2.97	3.14	3.28		
500.0	46.45	60.30	74.65	2.96	3.13	3.27		
1000.0	65.30	84.50	104.5	2.96	3.12	3.26		
infin				2.95	3.11	3.24		

Capacitance on 40-wire lines

microfarad per loop mile

	165 mil	128 mil	104 mil
In space (no insulators)	0.00978	0.00928	0.00888
On 40-wire line, dry	0.01003	0.00951	0.00912

continued

Telephone transmission line data**Characteristics of standard types of aerial copper wire telephone circuits at 1000 cycles per second**

type of circuit	gauge of wires (mils)	spacing of wires (inches)	primary constants per loop mile				propagation constant				line impedance				wave-length miles	velocity miles per second	attenuation — db per mile
			R ohms	L henries	C μ f	G μ mho	polar		rectangular		polar		rectangular				
							magni-tude	angle deg +	α	β	magni-tude	angle deg —	R ohms	X ohms —			
Non-Pole Pair Phys	165	8	4.11	.00311	.00996	.14	.0353	83.99	.00370	.0351	565	5.88	562	58	179.0	179,000	.0321
Non-Pole Pair Side	165	12	4.11	.00337	.00915	.29	.0352	84.36	.00346	.0350	612	5.35	610	57	179.5	179,500	.0300
Pole Pair Side	165	18	4.11	.00364	.00863	.29	.0355	84.75	.00325	.0353	653	5.00	651	57	178.0	178,000	.0282
Non-Pole Pair Phan	165	12	2.06	.00208	.01514	.58	.0355	85.34	.00288	.0354	373	4.30	372	28	177.5	177,500	.0250
Non-Pole Pair Phys	128	8	6.74	.00327	.00944	.14	.0358	80.85	.00569	.0353	603	8.97	596	94	178.0	178,000	.0494
Non-Pole Pair Side	128	12	6.74	.00353	.00871	.29	.0356	81.39	.00533	.0352	650	8.32	643	94	178.5	178,500	.0462
Pole Pair Side	128	18	6.74	.00380	.00825	.29	.0358	81.95	.00502	.0355	693	7.72	686	93	177.0	177,000	.0436
Non-Pole Pair Phan	128	12	3.37	.00216	.01454	.58	.0357	82.84	.00445	.0355	401	6.73	398	47	177.0	177,000	.0386
Non-Pole Pair Phys	104	8	10.15	.00340	.00905	.14	.0367	77.22	.00811	.0358	644	12.63	629	141	175.5	175,500	.0704
Non-Pole Pair Side	104	12	10.15	.00366	.00837	.29	.0363	77.93	.00760	.0355	692	11.75	677	141	177.0	177,000	.0660
Pole Pair Side	104	18	10.15	.00393	.00797	.29	.0365	78.66	.00718	.0358	730	10.97	717	139	175.5	175,500	.0624
Non-Pole Pair Phan	104	12	5.08	.00223	.01409	.58	.0363	79.84	.00640	.0357	421	9.70	415	71	176.0	176,000	.0556

Notes: 1. All values are for dry weather conditions.

2. All capacitance values assume a line carrying 40 wires.

3. Resistance values are for temperature of 20° C (68° F).

4. DP (Double Petticoat) Insulators assumed for all 12-inch and 18-inch spaced wires—CS (Special Glass with Steel Pin) Insulators assumed for all 8-inch spaced wires.

Telephone transmission line data *continued*

Attenuation of 12-inch spaced open-wire pairs

Toll and DP (double petticoat) insulators

size wire weather	attenuation in db per mile					
	165 mil		128 mil		104 mil	
	dry	wet	dry	wet	dry	wet
frequency cycles per sec						
20	.0127	.0279	.0163	.0361	.0198	.0444
100	.0231	.0320	.0318	.0427	.0402	.0535
500	.0288	.0367	.0445	.0530	.0620	.0715
1000	.0300	.0387	.0444	.0557	.0661	.0760
2000	.0324	.0431	.0486	.0598	.0686	.0804
3000	.0360	.0485	.0511	.0642	.0707	.0845
5000	.0439	.0598	.0573	.0748	.0757	.0938
7000	.051	.070	.064	.085	.082	.103
10000	.061	.085	.076	.102	.093	.120
15000	.076	.108	.094	.127	.111	.147
20000	.088	.127	.108	.150	.129	.173
30000	.110	.161	.135	.188	.159	.216
40000	.130	.192	.158	.223	.185	.254
50000	.148	.220	.179	.253	.209	.287

CS (special glass with steel pin) insulators

20	.0126	.0252	.0162	.0326	.0197	.0402
100	.0230	.0303	.0317	.0406	.0401	.0509
500	.0286	.0348	.0441	.0510	.0618	.0693
1000	.0296	.0354	.0458	.0532	.0655	.0735
2000	.0318	.0399	.0475	.0561	.0676	.0767
3000	.0346	.0437	.0495	.0593	.0694	.0797
5000	.0412	.0531	.0547	.0668	.0731	.0856
7000	.048	.061	.062	.075	.078	.093
10000	.057	.072	.071	.087	.088	.104
15000	.068	.087	.085	.105	.104	.123
20000	.078	.099	.079	.121	.119	.141
30000	.096	.121	.120	.146	.145	.171
40000	.111	.138	.138	.166	.166	.195
50000	.125	.153	.154	.184	.185	.215

Attenuation of 8-inch spaced open-wire pairs

CS insulators

size wire weather	attenuation in db per mile					
	165 mil		128 mil		104 mil	
	dry	wet	dry	wet	dry	wet
frequency cycles per sec						
10000	.053	.074	.079	.090	.095	.109
20000	.054	.101	.104	.124	.127	.145
30000	.101	.124	.125	.150	.151	.177
50000	.129	.161	.159	.194	.190	.228
70000	.150	.194	.185	.232	.222	.270
100000	.178	.236	.220	.280	.262	.325
120000	.195	.261	.240	.310	.286	.359
140000	.211	.285	.259	.337	.308	.390
150000	.218	.296	.268	.350	.317	.403

Telephone transmission line data *continued*

Line and propagation constants of 16- and 19-AWG toll cable

loop mile basis non-loaded temperature 55° F

frequency kc per sec	resistance ohms per mile	inductance milli- henries per mile	conductance μ mo per mile	capacitance μ f per mile	attenuation db per mile	phase shift radians per mile	characteristic impedance ohms
16-gauge							
1	40.1	1.097	1	0.0588	0.69	0.09	251—/215
2	40.3	1.095	2	0.0588	0.94	0.14	190—/141
3	40.4	1.094	4	0.0587	1.05	0.19	170—/108
5	40.7	1.092	8	0.0588	1.15	0.28	154—/71
10	42.5	1.085	19	0.0587	1.30	0.54	142—/42
20	47.5	1.066	49	0.0585	1.54	1.01	137—/23
30	53.5	1.046	83	0.0584	1.77	1.49	135—/17
50	66.5	1.013	164	0.0582	2.25	2.43	133—/13
100	91.6	0.963	410	0.0580	3.30	4.71	129—/9
150	111.0	0.934	690	0.0578	4.17	6.94	127—/7
19-gauge							
1	83.6	1.108	1	0.0609	1.05	0.132	345—/319
2	83.7	1.108	3	0.0609	1.44	0.190	254—/215
3	83.8	1.107	4	0.0609	1.73	0.249	215—/170
5	84.0	1.106	9	0.0609	2.02	0.347	181—/121
10	85.0	1.103	22	0.0608	2.43	0.584	153—/72
20	88.5	1.094	56	0.0607	2.77	1.07	141—/41
30	93.5	1.083	98	0.0606	3.02	1.56	137—/29
50	105.4	1.062	193	0.0604	3.53	2.55	134—/20
100	136.0	1.016	484	0.0601	4.79	4.94	131—/13
150	164.4	0.985	830	0.0599	6.01	7.27	129—/10

Approximate characteristics of standard types of paper-insulated

wire gauge AWG	type of loading*	spacing of load coils miles	load coil constants per load section		constants assumed to be distributed per loop mile				propagation polar	
			R ohms	L henries	R ohms	L henries	C μ f	G μ mo	magni- tude	angle deg +
side circuit										
19	N.L.S.	—	—	—	85.8	.001	.062	1.5	.183	47.0
19	H-31-S	1.135	2.7	.031	88.2	.028	.062	1.5	.277	76.6
19	H-44-S	1.135	4.1	.043	89.4	.039	.062	1.5	.319	79.9
19	H-88-S	1.135	7.3	.088	92.2	.078	.062	1.5	.441	84.6
19	H-172-S	1.135	13.0	.170	97.3	.151	.062	1.5	.610	87.0
19	B-88-S	0.568	7.3	.088	98.7	.156	.062	1.5	.620	87.0
16	N.L.S.	—	—	—	42.1	.001	.062	1.5	.129	49.1
16	H-31-S	1.135	2.7	.031	44.5	.028	.062	1.5	.266	82.8
16	H-44-S	1.135	4.1	.043	45.7	.039	.062	1.5	.315	84.6
16	H-88-S	1.135	7.3	.088	48.5	.078	.062	1.5	.438	87.6
16	H-172-S	1.135	13.0	.170	53.6	.151	.062	1.5	.608	88.3
16	B-88-S	0.568	7.3	.088	54.9	.156	.062	1.5	.618	88.3
13	N.L.S.	—	—	—	21.9	.001	.062	1.5	.094	52.9
phantom circuit										
19	N.L.P.	—	—	—	42.9	.0007	.100	2.4	.165	47.8
19	H-18-P	1.135	1.4	.018	44.1	.017	.100	2.4	.270	78.7
19	H-25-P	1.135	2.1	.025	44.7	.023	.100	2.4	.308	81.3
19	H-50-P	1.135	3.7	.050	46.2	.045	.100	2.4	.424	85.3
19	H-63-P	1.135	6.1	.063	48.3	.056	.100	2.4	.472	86.0
19	B-50-P	0.568	3.7	.050	49.4	.089	.100	2.4	.594	87.4
16	N.L.P.	—	—	—	21.0	.0007	.100	2.4	.116	50.0
16	H-18-P	1.135	1.4	.018	22.2	.017	.100	2.4	.262	84.0
16	H-25-P	1.135	2.1	.025	22.8	.023	.100	2.4	.303	85.4
16	H-50-P	1.135	3.7	.050	24.3	.045	.100	2.4	.422	87.4
16	H-63-P	1.135	6.1	.063	26.4	.056	.100	2.4	.471	87.7
16	B-50-P	0.568	3.7	.050	27.5	.089	.100	2.4	.593	88.5
13	N.L.P.	—	—	—	10.9	.0007	.100	2.4	.086	55.1

physical circuit

16 | B-22 | 0.568 | 1.25 | .022 | 43.1 | .040 | .062 | 1.5 | .315 | 85.0

* The letters H and B indicate loading coil spacings of 6000 and 3000 feet, respectively.

Telephone transmission line data *continued*

Line constants of shielded 16-gauge spiral-four toll-entrance cable

loop mile basis non-loaded temperature 70° F

frequency kc per sec	resistance ohms per mile	inductance mh per mile	conductance μmho per mile	capacitance μf per mile	attenuation db per mile
side circuit					
0.4	43.5	1.913	0.02	0.0247	0.92
0.6	43.5	1.907	0.04	0.0247	0.93
0.8	43.6	1.901	0.06	0.0247	0.93
1.0	43.9	1.891	0.08	0.0247	0.94
2	44.2	1.857	0.20	0.0247	0.95
3	45.2	1.821	0.32	0.0247	0.96
5	49.0	1.753	0.53	0.0247	0.97
10	55.1	1.626	1.11	0.0247	1.00
20	61.6	1.539	2.49	0.0247	1.06
30	66.1	1.507	3.77	0.0247	1.15
40	71.0	1.490	5.50	0.0247	1.26
60	81.5	1.467	8.80	0.0247	1.44
80	90.1	1.450	12.2	0.0247	1.60
100	97.8	1.438	15.81	0.0247	1.77
120	104.9	1.429	19.6	0.0247	1.90
140	111.0	1.421	23.3	0.0247	2.03
200	127.3	1.411	35.1	0.0246	2.35
250	137.0	1.408	46.0	0.0246	—
300	149.5	1.406	56.5	0.0246	—
350	159.9	1.405	67.8	0.0246	—

Characteristic impedance of this cable at 140 kilocycles approximately 240 ohms.
For a description and illustration of this type cable see Kendall and Afel, "A Twelve-Channel Carrier Telephone System for Open-Wire Lines," B.S.T.J., January 1939, pp. 129-131.

toll telephone cable circuits at 1000 cycles per second

constant		line impedance				wave-length miles	velocity miles per second	cut-off frequency f _c	attenuation decibels per mile
rectangular α	β	polar magni- tude	angle deg —	rectangular R ohms	X ohms				
.1249	.134	470.	42.8	345.	319.4	46.9	46900	—	1.08
.0643	.269	710.	13.2	691.	162.2	23.3	23300	6700	.56
.0561	.314	818.	9.9	806.	140.8	20.0	20000	5700	.49
.0418	.439	1131.	5.2	1126.	102.8	14.3	14300	4000	.36
.0323	.609	1565.	2.8	1563.	76.9	10.3	10300	2900	.28
.0322	.619	1590.	2.8	1588.	76.7	10.2	10200	5700	.28
.0842	.097	331.	40.7	251.	215.4	64.5	64500	—	.73
.0334	.264	683.	7.0	677.	83.0	23.8	23800	6700	.29
.0296	.313	808.	5.2	805.	72.8	20.1	20000	5700	.26
.0224	.437	1124.	2.7	1123.	53.1	14.4	14400	4000	.19
.0183	.608	1562.	1.5	1562.	41.1	10.3	10300	2900	.16
.0185	.618	1587.	1.5	1587.	41.4	10.2	10200	5700	.16
.0568	.075	242.	36.9	194.	145.2	83.6	83600	—	.19
.1106	.122	262.	42.0	195.	175.2	51.5	51500	—	.96
.0529	.264	429.	11.1	421.	82.6	23.8	23800	7000	.46
.0466	.305	491.	8.5	485.	72.4	20.6	20600	5900	.40
.0351	.423	675.	4.5	673.	53.3	14.9	14900	4200	.30
.0331	.471	752.	3.8	750.	49.8	13.3	13300	3700	.29
.0273	.593	945.	2.4	944.	39.8	10.6	10600	5900	.24
.0746	.089	185.	39.0	144.	116.3	70.6	70600	—	.65
.0273	.260	417.	5.8	415.	41.8	24.1	24100	7000	.24
.0243	.302	483.	4.4	481.	36.8	20.8	20800	5900	.21
.0189	.422	672.	2.4	672.	27.5	14.9	14900	4200	.16
.0185	.471	749.	2.0	749.	26.6	13.4	13400	3700	.16
.0157	.593	944.	1.3	944.	21.4	10.6	10600	5900	.14
.0442	.071	137.	33.9	114.	76.3	89.1	89100	—	.43
.0273	.314	809.	4.8	806.	67.1	20.0	20000	11300	.24

Approximate characteristics of standard types of paper-insulated exchange telephone cable circuits

1000 cycles per second

wire gauge AWG	code no	type of loading	loop mile constants		propagation constant				mid-section characteristic impedance				wave length miles	velocity miles per second	cut-off freq	atten db per mile
			C μ F	G μ mho	polar		rectangular		polar		rectangular					
					mag	angle (deg)	α	β	mag	angle (deg)	Z ₀₁	Z ₀₂				
26	BST	NL	.083	1.6	—	—	—	—	910	—	—	—	—	—	—	2.9
	ST	NL	.069	1.6	.439	45.30	.307	.310	1037	44.5	719	706	20.4	20,400	—	2.67
24	DSM	NL	.085	1.9	—	—	—	—	725	—	—	—	—	—	—	2.3
	ASM	NL	.075	1.9	.355	45.53	.247	.251	778	44.2	558	543	25.0	25,000	—	2.15
		M88	.075	1.9	.448	70.25	.151	.421	987	23.7	904	396	14.9	14,900	3100	1.31
		H88	.075	1.9	.512	75.28	.130	.495	1160	14.6	1122	292	12.7	12,700	3700	1.13
		B88	.075	1.9	.684	81.70	.099	.677	1532	8.1	1515	215	9.3	9,270	5300	0.86
22	CSA	NL	.083	2.1	.297	45.92	.207	.213	576	43.8	416	399	29.4	29,400	—	1.80
		M88	.033	2.1	.447	76.27	.106	.434	905	13.7	880	214	14.5	14,500	2900	0.92
		H88	.083	2.1	.526	80.11	.0904	.519	1051	9.7	1040	177	12.1	12,100	3500	0.79
		H135	.083	2.1	.644	83.50	.0729	.640	1306	6.3	1300	144	9.8	9,800	2800	0.63
		B88	.083	2.1	.718	84.50	.0689	.718	1420	5.3	1410	130	8.75	8,750	5000	0.60
		B135	.083	2.1	.890	86.50	.0549	.890	1765	3.3	1770	102	7.05	7,050	4000	0.48
19	CNB	NL	.085	1.6	—	—	—	—	400	—	—	—	—	—	—	1.23
	DNB	NL	.066	1.6	.188	47.00	.128	.138	453	42.8	333	308	45.7	45,700	—	1.12
		M88	.066	1.6	.383	82.42	.0505	.380	950	8.9	939	146	16.6	16,600	3200	0.44
		H88	.066	1.6	.459	84.60	.0432	.459	1137	5.2	1130	103	13.7	13,700	3900	0.38
		H135	.066	1.6	.569	86.53	.0345	.570	1413	4.0	1410	99	11.0	11,000	3200	0.30
		H175	.066	1.6	.651	87.23	.0315	.651	1643	3.3	1640	95	9.7	9,700	2800	0.27
		B88	.066	1.6	.641	86.94	.0342	.641	1565	2.8	1560	77	9.8	9,800	5500	0.30
16	NH	NL	.064	1.5	.133	49.10	.0868	.1004	320	40.6	243	208	62.6	62,600	—	0.76
		M88	.064	1.5	.377	85.08	.0271	.377	937	4.6	934	76	16.7	16,700	3200	0.24
		H88	.064	1.5	.458	87.14	.0238	.458	1130	2.8	1130	55	13.7	13,700	3900	0.21

In the third column of the above table the letters M, H, and B indicate loading coil spacings of 9000 feet, 6000 feet, and 3000 feet, respectively, and the figures show the inductance of the loading coils used.

Open wire

Type J

Frequency allocation chart for type J and K carrier systems

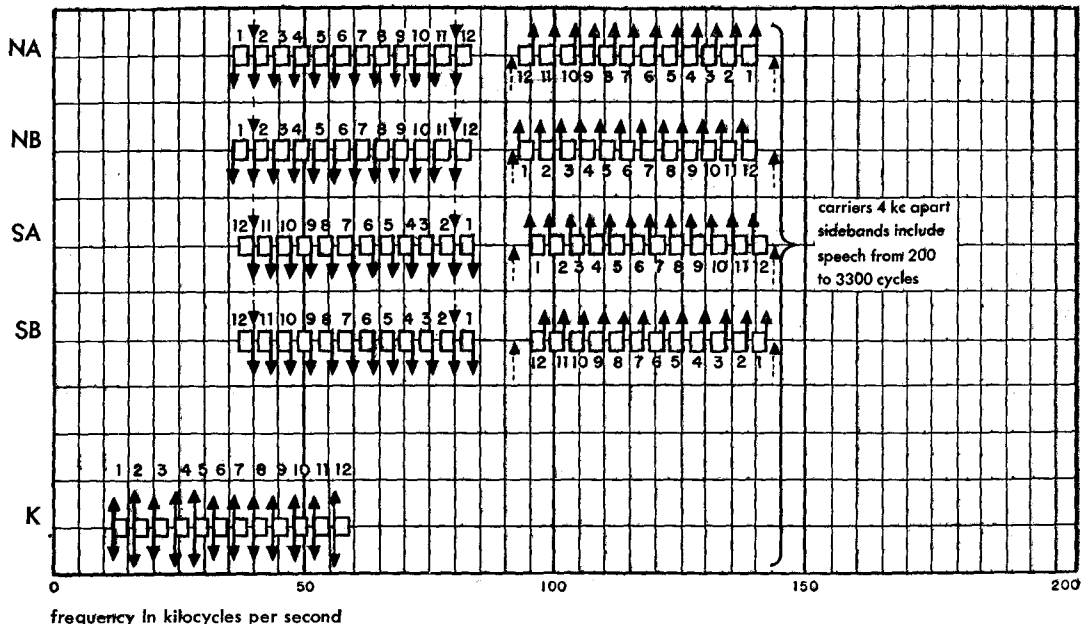

Cable

Pilot frequencies for the K system are 12, 28, and 56 kilocycles per second

Note: Frequency allocations shown in this chart and in the charts on pages 186, 187, and 188 are as used by the Bell System and the I. T. & T. System.

solid arrows denote carriers
 dotted arrows denote pilot frequencies
 ↑ denotes east-west ↓ denotes west-east
 □ = channel no 7
 the line frequencies shown are obtained
 by two or more stages of modulation

Carrier telephone

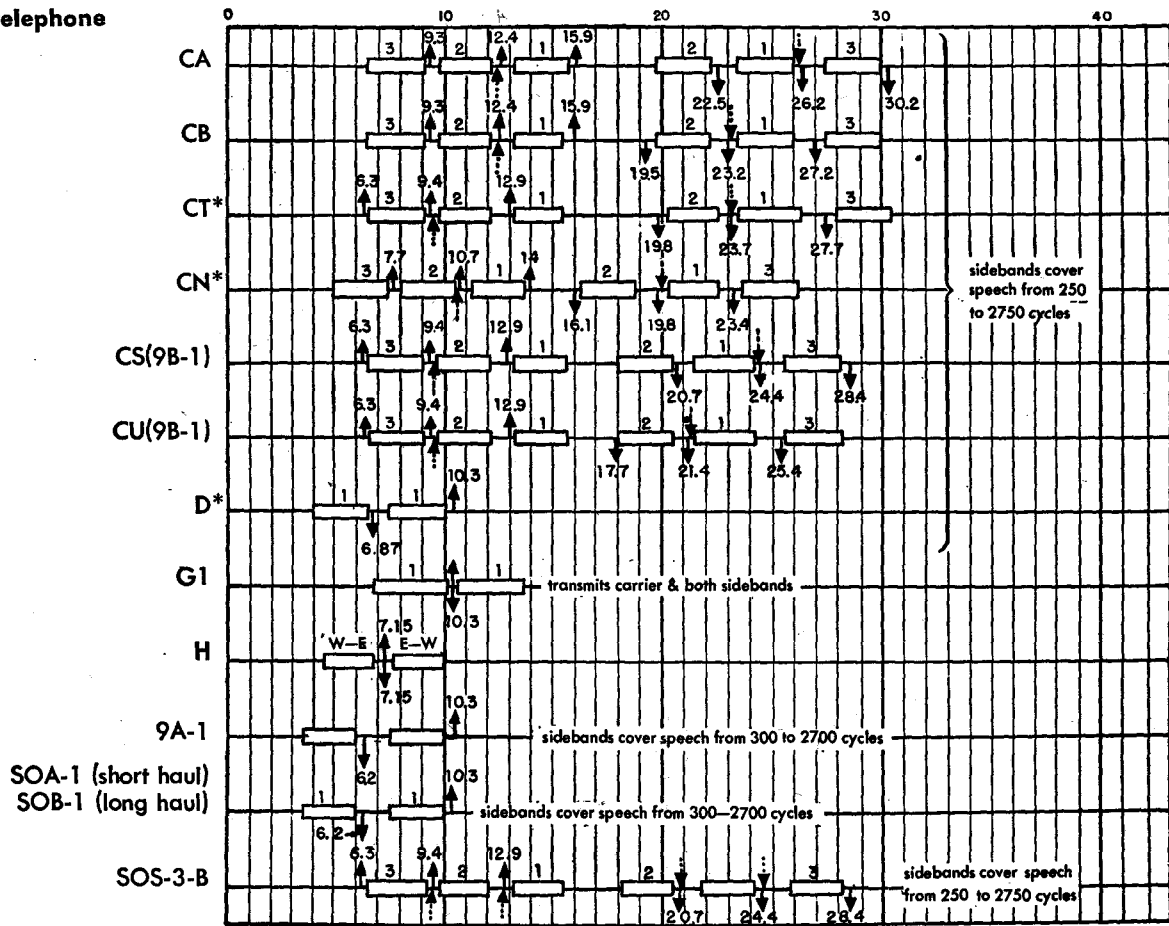

Program

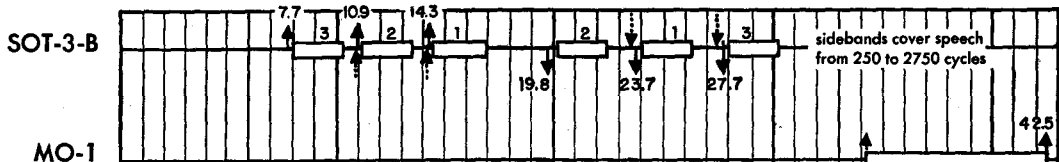

**Carrier telegraph
Voice frequency**

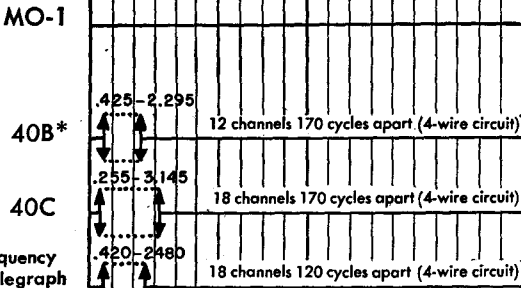

High frequency

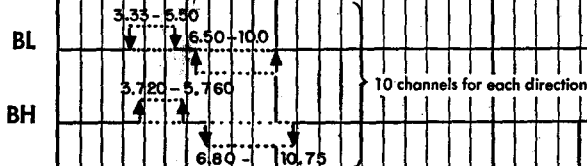

Miscellaneous

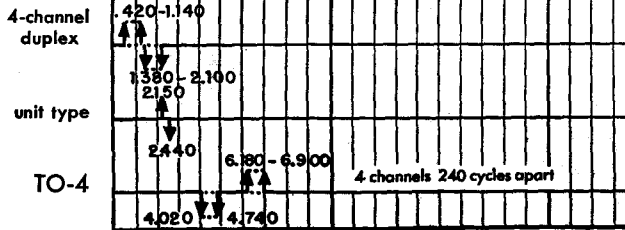

solid arrows denote carrier
dotted arrows denote pilot frequencies
↑ denotes east-west or A-B
↓ denotes west-east or B-A
2 = channel no 2
* manufacture discontinued

frequency in kilocycles per second

C.E. Jamnis
WIRE TRANSMISSION 187

Frequency allocation and modulation steps in the L carrier system

coaxial cable

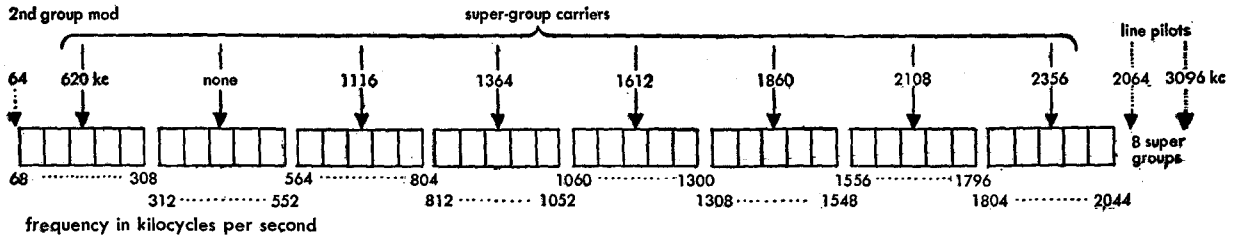
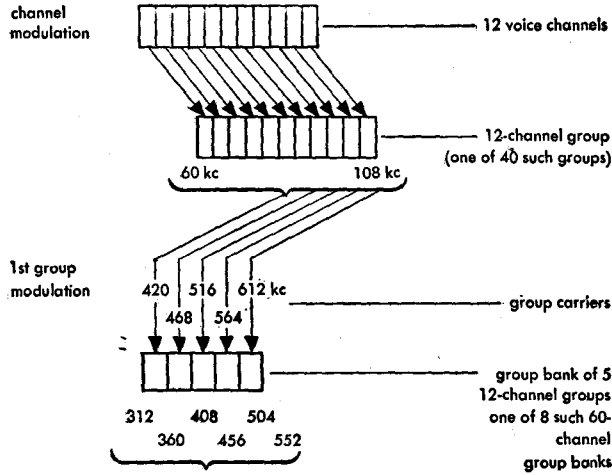

Noise and noise measurement *wire telephony***Definitions**

The following definitions are based upon those given in the Proceedings of the tenth Plenary Meeting (1934) of the *Comité Consultatif International Téléphonique (C.C.I.F.)*.

Note: The unit in which noise is expressed in many of the European countries differs from the two American standards, the *noise unit* and the *db above reference noise*. The European unit is referred to as the *psophometric electromotive force*.

Noise: Is a sound which tends to interfere with a correct perception of vocal sounds, desired to be heard in the course of a telephone conversation.

It is customary to distinguish between:

1. **Room noise:** Present in that part of the room where the telephone apparatus is used.
2. **Frying noise (transmitter noise):** Produced by the microphone, manifest even when conversation is not taking place.
3. **Line noise:** All noise electrically transmitted by the circuit, other than room noise and frying noise.

Psophometric electromotive force

In the case of a complete telephone connection the interference with a telephone conversation produced by extraneous currents may be compared with the interference which would be caused by a parasitic sinusoidal current of 800 cycles per second. The strength of the latter current, when the interference is the same in both cases, can be determined.

If the receiver used has a resistance of 600 ohms and a negligible reactance (if necessary it should be connected through a suitable transformer), the psophometric electromotive force at the end of a circuit is defined as twice the voltage at 800 cycles per second, measured at the terminals of the receiver under the conditions described.

The psophometric electromotive force is therefore the electromotive force of a source having an internal resistance of 600 ohms and zero internal reactance which, when connected directly to a standard receiver of 600 ohms resistance and zero reactance, produces the same sinusoidal current at 800 cycles per second as in the case with the arrangements indicated above.

Noise and noise measurement *continued*

An instrument known as the *psophometer* has been designed. When connected directly across the terminals of the 600-ohm receiver, it gives a reading of half of the psophometric electromotive force for the particular case considered.

In a general way, the term *psophometric voltage* between any two points refers to the reading on the instrument when connected to these two points.

If, instead of a complete connection, only a section thereof is under consideration, the psophometric electromotive force with respect to the end of that section is defined as twice the psophometric voltage measured at the terminals of a pure resistance of 600 ohms, connected at the end of the section, if necessary through a suitable transformer.

The C. C. I. F. has published a Specification for a psophometer which is included in Volume II of the Proceedings of the Tenth Plenary Meeting in 1934. An important part of this psophometer is a filter network associated with the measuring circuit whose function is to *weight* each frequency in accordance with its interference value relative to a frequency of 800 cycles.

Noise levels

The amount of noise found on different circuits, and even on the same circuit at different times, varies through quite wide limits. Further, there is no definite agreement as to what constitutes a *quiet* circuit, a *noisy* circuit, etc. The following values should therefore be regarded merely as a rough indication of the general levels which may be encountered under the different conditions:

Open-wire circuit	db above ref noise
Quiet	20
Average	35
Noisy	50
Cable circuit	
Quiet	15
Average	25
Noisy	40

Relationship of European and American noise units

The psophometric emf can be related to the American units: the *noise unit* and the *decibel above reference noise*.

The following chart shows this relationship together with correction factors for psophometric measurements on circuits of impedance other than 600 ohms.

Noise and noise measurement *continued*

Relationship of European and American units

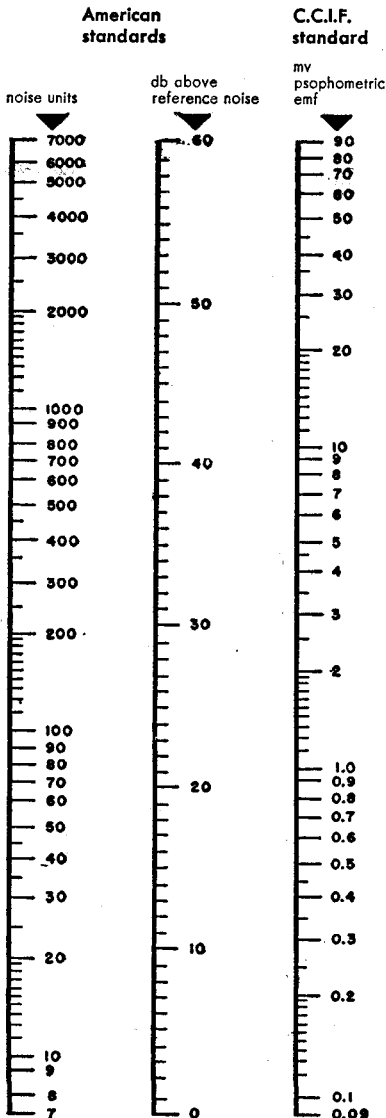

1. The relationship of noise units to db's above reference noise is obtained from technical report No. 1B-5 of the joint subcommittee on development and research of the Bell Telephone System and the Edison Electric Institute.

2. The relationship of db's above reference noise to psophometric emf is obtained from the Proceedings of C.C.I.F. 1934.

3. The C.C.I.F. expresses noise limits in terms of the psophometric emf for a circuit of 600 ohms resistance and zero reactance, terminated in a resistance of 600 ohms. Measurements made in terms of the potential difference across the terminations, or on circuits of impedance other than 600 ohms, should be corrected as follows:

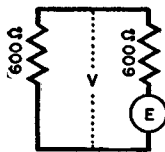

Psophometric emf = E
E = 2V

a psophometer measures V not E

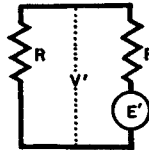

$$E = E' \sqrt{\frac{600}{R}}$$

$$= 2V' \sqrt{\frac{600}{R}}$$

4. Reference noise—with respect to which the American noise measuring set is calibrated—is a 1000 cycles per second tone 90 db below 1 milliwatt.

Telegraph facilities

	speed of usual types	
	frequency cycles	bauds
Grounded wire	75	150
Simplex (telephone)	50	100
Composite	15	30
Metallic telegraph	85	170
Carrier channel		
Narrow band	40	80
Wide band	75	150

Telegraph printer systems

Speed depends on two factors: 1. Code used, and 2. frequency handling capacity of transmission facilities. One (1) word = 5 letters and 1 space.

Frequency of printing telegraph systems in cycles per second

Let

S = number of units in code (plus allowance for synchronizing)

N = number of channels

W = revolutions per second

$$= \frac{\text{words per minute} \times \text{characters per transmitted word}}{60}$$

(1 word is assumed to consist of 5 letters and 1 space, or 6 characters.)

$$f = \text{frequency in cycles per second} \quad f = \frac{1}{2} SNW$$

Examples

1. Three-channel multiplex operating at 60 words per minute, 5-unit code.

$$f = \frac{1}{2} \times 5 \times 3 \times \frac{60 \times 6}{60} = 45 \text{ cycles or } 90 \text{ bauds}$$

2. Single-printer circuit operating at 60 words per minute, 5-unit code + $2\frac{1}{2}$ units for synchronizing.

$$f = \frac{1}{2} \times 7\frac{1}{2} \times 1 \times \frac{60 \times 6}{60} = 22\frac{1}{2} \text{ cycles or } 45 \text{ bauds}$$

3. Two-channel Baudot operating at 50 words per minute, 5-unit code + 2 units for synchronizing.

$$f = \frac{1}{2} (5 + 2) \times 2 \times \frac{50 \times 6}{60} = 35 \text{ cycles or } 70 \text{ bauds}$$

Comparison of telegraph codes

American Morse 

Continental Morse 

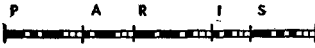
Bain 

Creed 

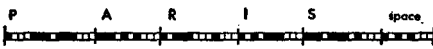
Barclay 

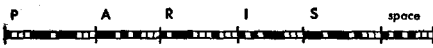
Buckingham 

Hughes 

Rowland 

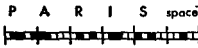
Murray Automatic 

Baudot 

Add 2 units to each channel for 2-channel and 1 unit to each character for 4-channel operation. These conditions allow for synchronization and retardation.

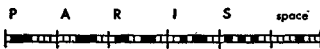
Morkrum 

Cable Morse 

Cook 

Multiple 

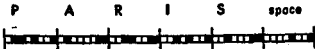
IBM (Globe Wireless) 

RCA 

■ Radio frequency transmission lines

Formulas for uniform transmission lines *losses neglected*

$$Z_o = \sqrt{\frac{L}{C}}$$

$$L = 1016 \sqrt{\epsilon} Z_o$$

$$C = 1016 \frac{\sqrt{\epsilon}}{Z_o}$$

$$\frac{V}{c} = \frac{1}{\sqrt{\epsilon}}$$

$$Z_s = Z_o \frac{Z_r + j Z_o \tan l^\circ}{Z_o + j Z_r \tan l^\circ}$$

$$Z_s = \frac{Z_o^2}{Z_r} \quad \text{for } l^\circ = 90^\circ \text{ (quarter wave)}$$

$$Z_{ss} = + j Z_o \tan l^\circ$$

$$Z_{so} = - \frac{j Z_o}{\tan l^\circ}$$

$$l^\circ = 360 \frac{l}{\lambda}$$

$$\lambda = \lambda_o \left(\frac{V}{c} \right)$$

where

L = inductance of transmission line in micromicrohenries per foot

C = capacitance of transmission line in micromicrofarads per foot

V = velocity of propagation in transmission line } same units
 c = velocity of propagation in free space }

Z_s = sending end impedance of transmission line in ohms

Z_o = surge impedance of transmission line in ohms

Z_r = terminating impedance of transmission line in ohms

l° = length of line in electrical degrees

l = length of line

λ = wavelength in transmission line } same units
 λ_o = wavelength in free space }

ε = dielectric constant of transmission line medium

= 1 for air

Z_{ss} = sending end impedance (ohms) of transmission line shorted at far end

Z_{so} = sending end impedance (ohms) of transmission line open at far end

Surge impedance of uniform lines—0 to 210 ohms

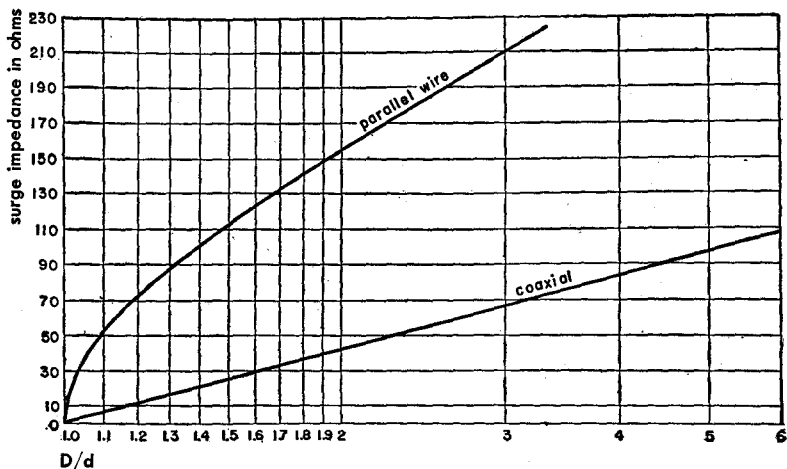

Surge impedance of uniform lines—0 to 700 ohms

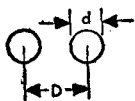
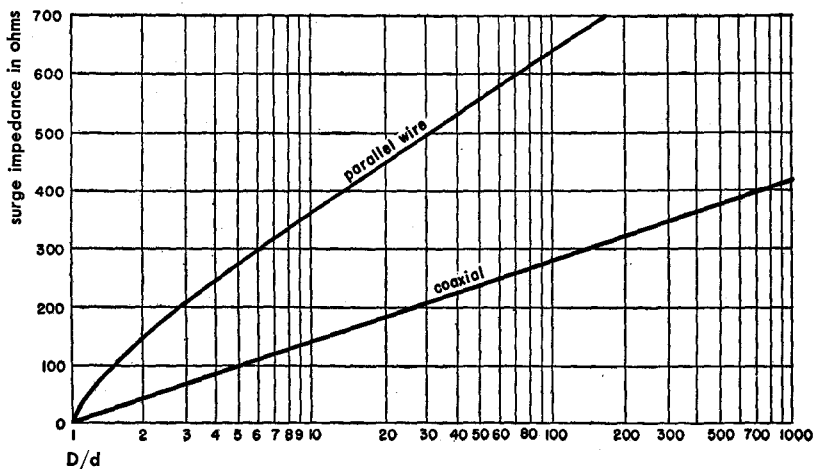

parallel wire

$$Z_0 = 120 \cosh^{-1} \frac{D}{d}$$

$$\cong 276 \log_{10} \frac{2D}{d}$$

for $D \gg d$

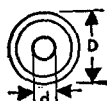

coaxial

$$Z_0 = 138 \log_{10} \frac{D}{d}$$

Transmission line data

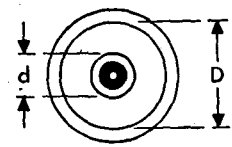
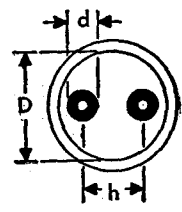
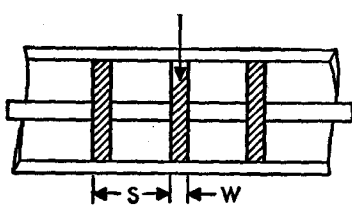
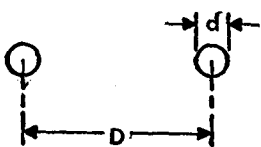
type of line	characteristic impedance
<p>A single coaxial line</p> 	$Z_0 = \frac{138}{\sqrt{\epsilon}} \log_{10} \frac{D}{d}$ <p>$\epsilon =$ dielectric constant $= 1$ in air</p>
<p>B balanced shielded line</p> 	<p>for $D \gg d, h \gg d$</p> $Z_0 \cong \frac{276}{\sqrt{\epsilon}} \log_{10} \left[2v \frac{1 - \sigma^2}{1 + \sigma^2} \right]$ $\sigma = \frac{h}{D}$ $v = \frac{h}{d}$
<p>C beads—dielectric ϵ_1</p> 	<p>for cases (A) and (B)</p> <p>if ceramic beads are used at frequent intervals—call new surge impedance Z_0'</p> $Z_0' = \frac{Z_0}{\sqrt{\epsilon + \frac{\epsilon_1 - \epsilon}{S} W}}$
<p>D open two-wire line</p> 	$Z_0 = 120 \cosh^{-1} \frac{D}{d}$ $\cong 276 \log_{10} \frac{2D}{d}$

Transmission line data—miscellaneous types

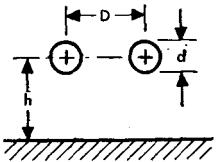
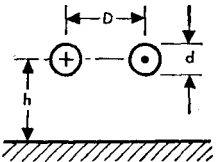
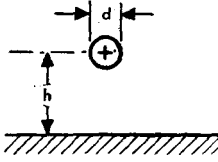
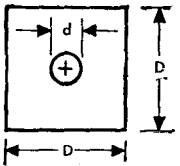
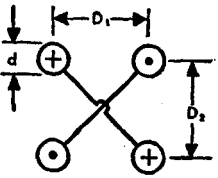
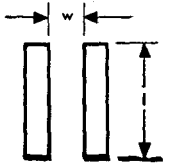
type of line	characteristic impedance
	$Z_0 = 69 \log_{10} \left[\frac{4h}{d} \sqrt{1 + \left(\frac{2h}{D} \right)^2} \right]$
	$Z_0 = 276 \log_{10} \left[\frac{4h}{d \sqrt{1 + \left(\frac{2h}{D} \right)^2}} \right]$
	$Z_0 = 138 \log_{10} \frac{4h}{d}$
	$Z_0 = 138 \log_{10} \frac{D}{d} \left[1.078 - 0.078 \left(\frac{d}{D} \right)^2 \right]$
	$Z_0 = 138 \log_{10} \frac{2D_2}{d \sqrt{1 + \left(\frac{D_2}{D_1} \right)^2}}$
	$l \gg w$ $Z_0 \cong 377 \frac{w}{l}$

Transmission line attenuation due to load mismatch

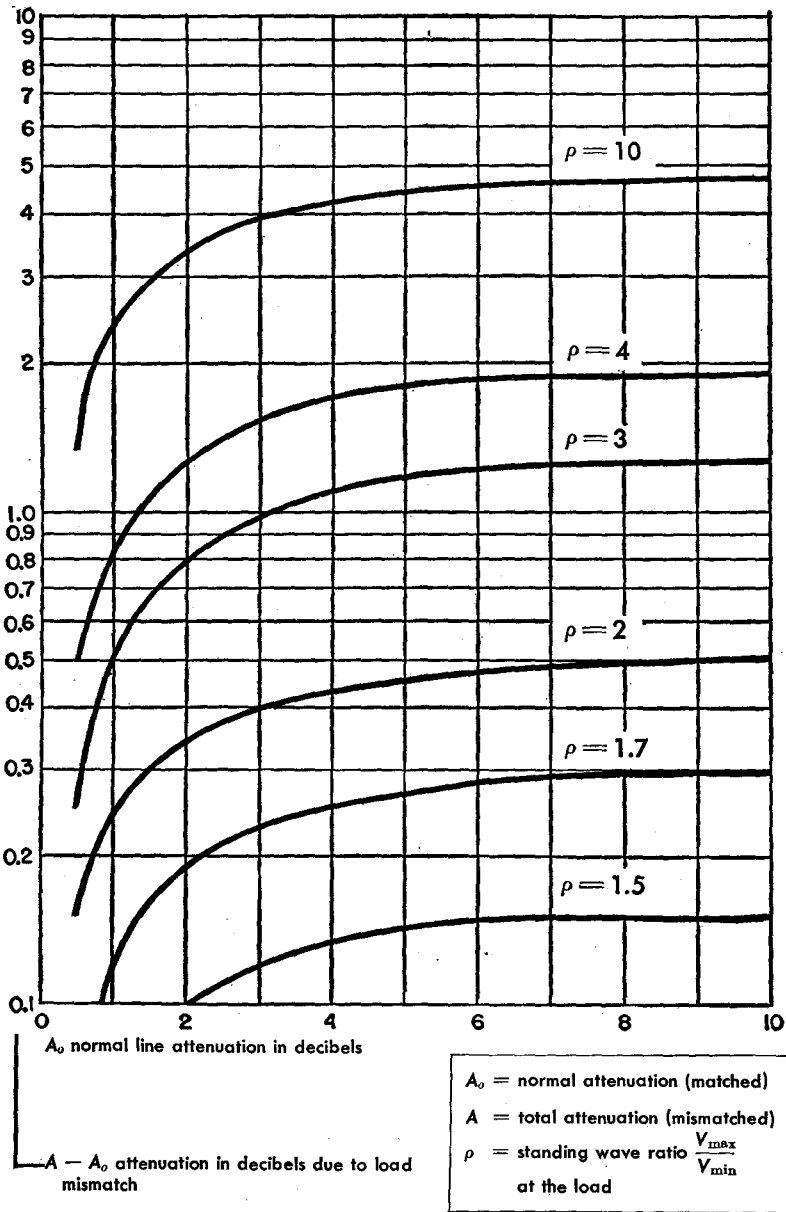

Impedance matching with shorted stub

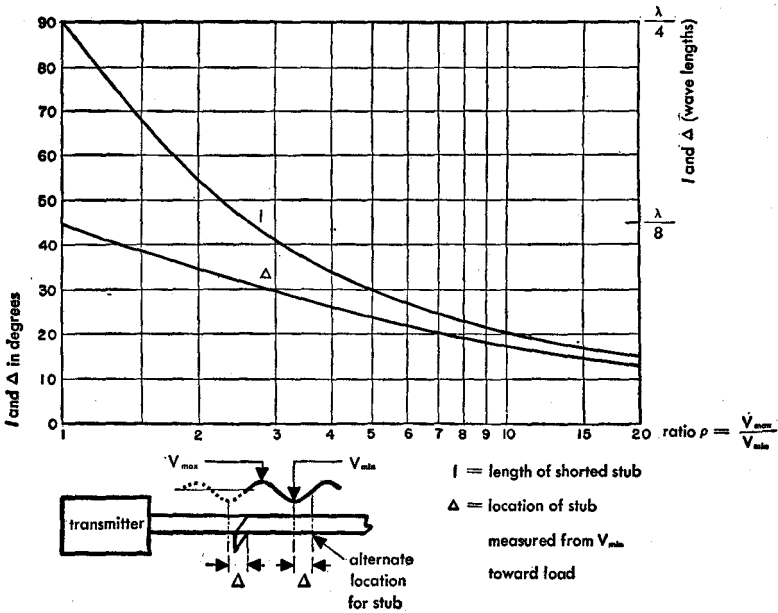

Impedance matching with open stub

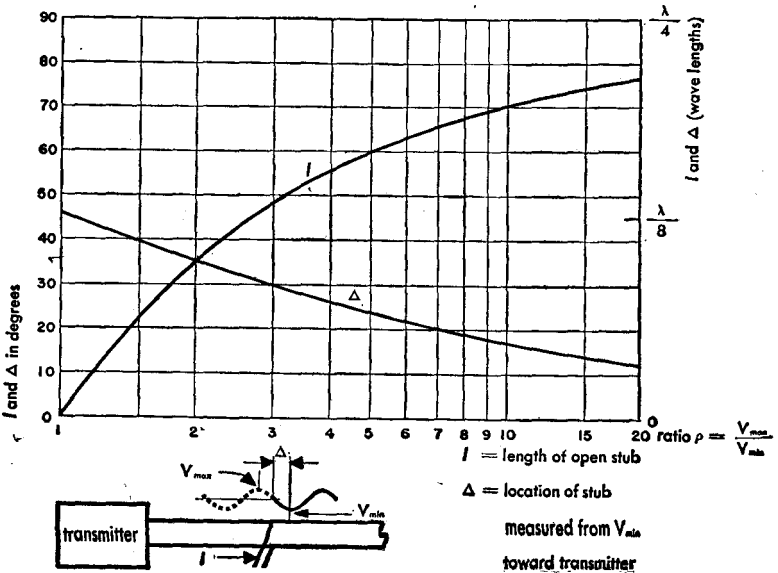

Impedance matching with coupled section

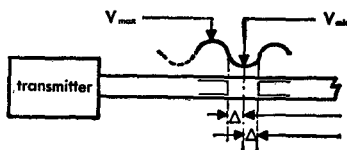
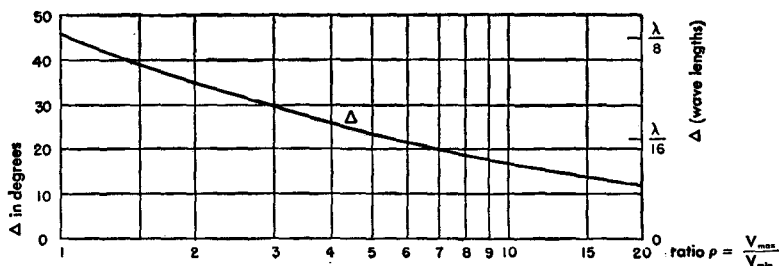

shorter than resonant section
longer than resonant section

Detuning from resonance for a particular type of section

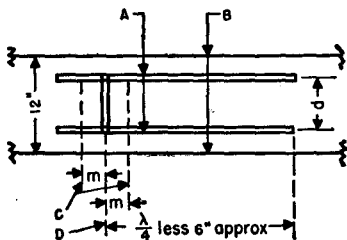
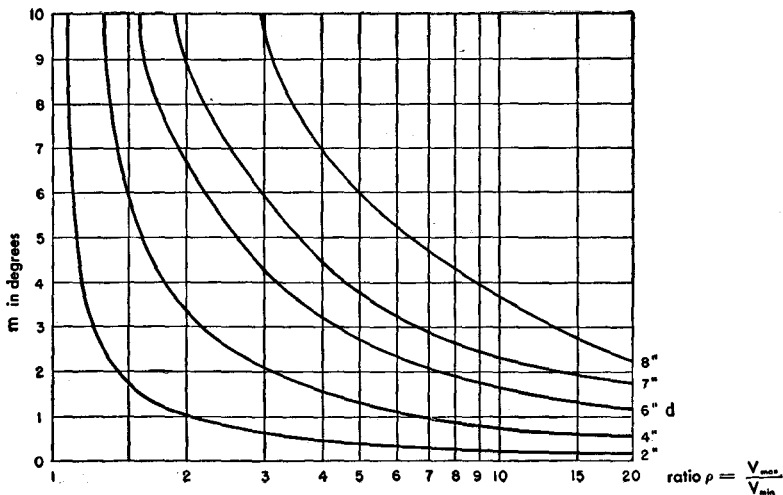

- A = coupled section—two 0.75-inch diameter copper tubes, coplanar with line
- B = transmission line—two 0.162-inch diameter wires
- C = alternative positions of shorting bar for impedance matching
- D = position of shorting bar for maximum current in section conductors

Army-Navy standard list of radio-frequency cables

class of cables	Army-Navy type number	inner conductor	dielectric material (1)	nominal diam of dielectric (in)	shielding braid	protective covering	nominal overall diam (in)	weight lb/ft	nominal impedance ohms	nominal capacitance $\mu\text{ft}/\text{ft}$	maximum operating voltage rms	remarks	
50-55 ohms	Single braid	RG-58/U	20 AWG copper	A	0.116	Tinned Copper	Vinyl	0.195	0.025	53.5	28.5	1,900	General purpose small size flexible cable
		RG-8/U	7/21 AWG copper	A	0.285	Copper	Vinyl	0.405	0.106	52.0	29.5	4,000	General purpose medium size flexible cable
		RG-10/U	7/21 AWG copper	A	0.285	Copper	Vinyl (non-contaminating) armor	(max) 0.475	0.146	52.0	29.5	4,000	Same as RG-8/U armored for naval equipment
		RG-17/U	0.188 copper	A	0.680	Copper	Vinyl (non-contaminating)	0.870	0.460	52.0	29.5	11,000	Large high power low attenuation transmission cable
		RG-18/U	0.188 copper	A	0.680	Copper	Vinyl (non-contaminating) armor	(max) 0.945	0.585	52.0	29.5	11,000	Same as RG-17/U armored for naval equipment
		RG-19/U	0.250 copper	A	0.910	Copper	Vinyl (non-contaminating)	0.120	0.740	52.0	29.5	14,000	Very large high power low attenuation transmission cable
		RG-20/U	0.250 copper	A	0.910	Copper	Vinyl (non-contaminating) armor	(max) 1.195	0.925	52.0	29.5	14,000	Same as RG-19/U armored for naval equipment
	Double braid	RG-55/U	20AWG copper	A	0.116	Tinned copper	Polyethylene	(max) 0.206	0.034	53.5	28.5	1,900	Small size flexible cable
		RG-5/U	16 AWG copper	A	0.185	Copper	Vinyl	0.332	0.087	53.5	28.5	2,000	Small microwave cable
		RG-9/U	7/21 AWG silvered copper	A	0.280	Inner—silver coated copper. Outer-copper	Vinyl (non-contaminating)	0.420	0.150	51.0	30.0	4,000	Medium size, low level circuit cable

Notes:

1. Dielectric materials

A Stabilized polyethylene

C Synthetic rubber compound

D Layer of synthetic rubber dielectric between thin layers of conducting rubber

continued **Army-Navy standard list of radio-frequency cables**

class of cables	Army-Navy type number	inner conductor	dielec material (1)	nominal diam of dielectric (in)	shielding braid	protective covering	nominal overall diam (in)	weight lb/ft	nominal impedance ohms	nominal capacitance $\mu\text{ft}/\text{ft}$	maximum operating voltage rms	remarks	
70-80 ohms	Single braid	RG-14/U	10 AWG copper	A	0.370	Copper	Vinyl (non-contaminating)	0.545	0.216	52.0	29.5	5,500	General purpose semi-flexible power transmission cable
		RG-74/U	10 AWG copper	A	0.370	Copper	Vinyl (non-contaminating) armor	0.615	0.310	52.0	29.5	5,500	Same as RG-14/U armored for naval equipment
	Double braid	RG-59/U	22 AWG copperweld	A	0.146	Copper	Vinyl	0.242	0.032	73.0	21.0	2,300	General purpose small size video cable
		RG-11/U	7/26 AWG tinned copper	A	0.285	Copper	Vinyl	0.405	0.096	75.0	20.5	4,000	Medium size, flexible video and communication cable
		RG-12/U	7/26 AWG tinned copper	A	0.285	Copper	Vinyl (non-contaminating) armor	0.475	0.141	75.0	20.5	4,000	Same as RG-11/U armored for naval equipment
		RG-6/U	21 AWG copperweld	A	0.185	Inner—silver coated copper. Outer—copper	Vinyl (non-contaminating)	0.332	0.082	76.0	20.0	2,700	Small size video and I-F cable
RG-13/U	7/26 AWG tinned copper	A	0.280	Copper	Vinyl	0.420	0.126	74.0	20.5	4,000	I-F cable		
Cables of special characteristics	Twin conductor	RG-22/U	2 Cond. 7/18 AWG copper	A	0.285	Single—tinned copper	Vinyl	0.405	0.107	95.0	16.0	1,000	Small size twin conductor cable
		RG-57/U	2 Cond. 7/21 AWG copper	A	0.472	Single—tinned copper	Vinyl	0.625	0.225	95.0	16.0	3,000	Large size twin conductor cable
	High attenuation	RG-21/U	16 AWG resistance wire	A	0.185	Inner—silver coated copper. Outer—copper	Vinyl (non-contaminating)	0.332	0.087	53.0	29.0	2,700	Special attenuating cable with small temperature coefficient of attenuation
	High impedance	RG-65/U	No. 32 Formex F helix diam 0.128 in.	A	0.285	Single—copper	Vinyl	0.405	0.096	95.0	44.0	1,000	High impedance video cable. High delay

continued

Army-Navy standard list of radio frequency cables

class of cables	Army-Navy type number	inner conductor	dielec material (1)	nominal diam of dielectric (in)	shielding braid	protective covering	nominal overall diam (in)	weight lb/ft	nominal impedance ohms	nominal capacitance $\mu\text{mf/ft}$	maximum operating voltage rms	remarks		
Low capacitance	Single braid	RG-62/U	22 AWG copperweld	A	0.146	Copper	Vinyl	0.242	0.0382	93.0	13.5 max 14.5	750	Small size low capacitance air-spaced cable	
		RG-63/U	22 AWG copperweld	A	0.285	Copper	Vinyl	0.405	0.0832	125	10.0 max 11.0	1,000	Medium size low capacitance air-spaced cable	
	Double braid	RG-71/U	22 AWG copperweld	A	0.146	Inner—plain copper. Outer—tinned copper	Polyethylene	0.250	0.0457	93.0	13.5 max 14.5	750	Small size low capacitance air-spaced cable for I-F purposes	
Pulse applications	Single braid	RG-26/U	19/0.0117 tinned copper	D	(2) 0.308	Tinned copper	Synthetic rubber and armor	(max) 0.525	0.189	48.0	50.0	8,000 (peak)	Medium size pulse cable armored for naval equipment	
		RG-27/U	19/0.0185 tinned copper	D	(2) 0.455	Single—tinned copper	Vinyl and armor	(max) 0.675	0.304	48.0	50.0	15,000 (peak)	Large size pulse cable armored for naval equipment	
	Double braid	RG-64/U	19/0.0117 tinned copper	D	(2) 0.308	Tinned copper	Neoprene	0.495	0.205	48.0	50.0	8,000 (peak)	Medium size pulse cable	
			RG-25/U	19/0.0117 tinned copper	D	(2) 0.308	Tinned copper	Neoprene	0.565	0.205	48.0	50.0	8,000 (peak)	Special twisting pulse cable for naval equipment
			RG-28/U	19/0.0185 tinned copper	D	(2) 0.455	Inner—tinned copper. Outer—galvanized steel	Synthetic rubber	0.805	0.370	48.0	50.0	15,000 (peak)	Large size pulse cable
Twisting application	Single braid	RG-41/U	16/30 AWG tinned copper	C	0.250	Tinned copper	Neoprene	0.425	0.150	67.5	27.0	3,000	Special twist cable	

Notes:

- Dielectric materials
 - Stabilized polyethylene
 - Synthetic rubber compound
 - Layer of synthetic rubber dielectric between thin layers of conducting rubber

2. This value is the diameter over the outer layer of conducting rubber.

Attenuation of standard r-f cables vs frequency

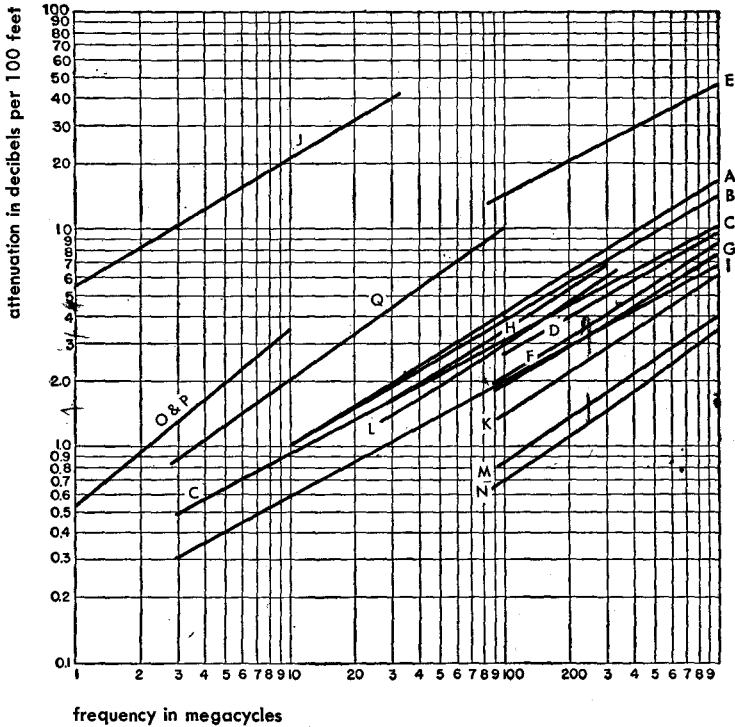

The above chart refers to cables listed in the Army-Navy standard list of radio-frequency cables on pages 201, 202, and 203. For an explanation of the letters accompanying the curves, see the table below. Each letter refers to one or more A-N standard cables. The number following the letter in the table is the numerical part of the RG- /U number as listed under "Army-Navy type number" in the third column of the preceding list.

RG—number

A 55/U	D 5/U	F 10/U	J 63/U	M 17/U	O 26/U
A 58/U	D 6/U	G 11/U	J 65/U	M 18/U	O 64/U
B 59/U	E 21/U	G 12/U	K 14/U	N 19/U	P 27/U
C 62/U	F 8/U	G 13/U	K 74/U	N 20/U	P 28/U
C 71/U	F 9/U	H 22/U	L 57/U	O 25/U	Q 4/U

Length of transmission line

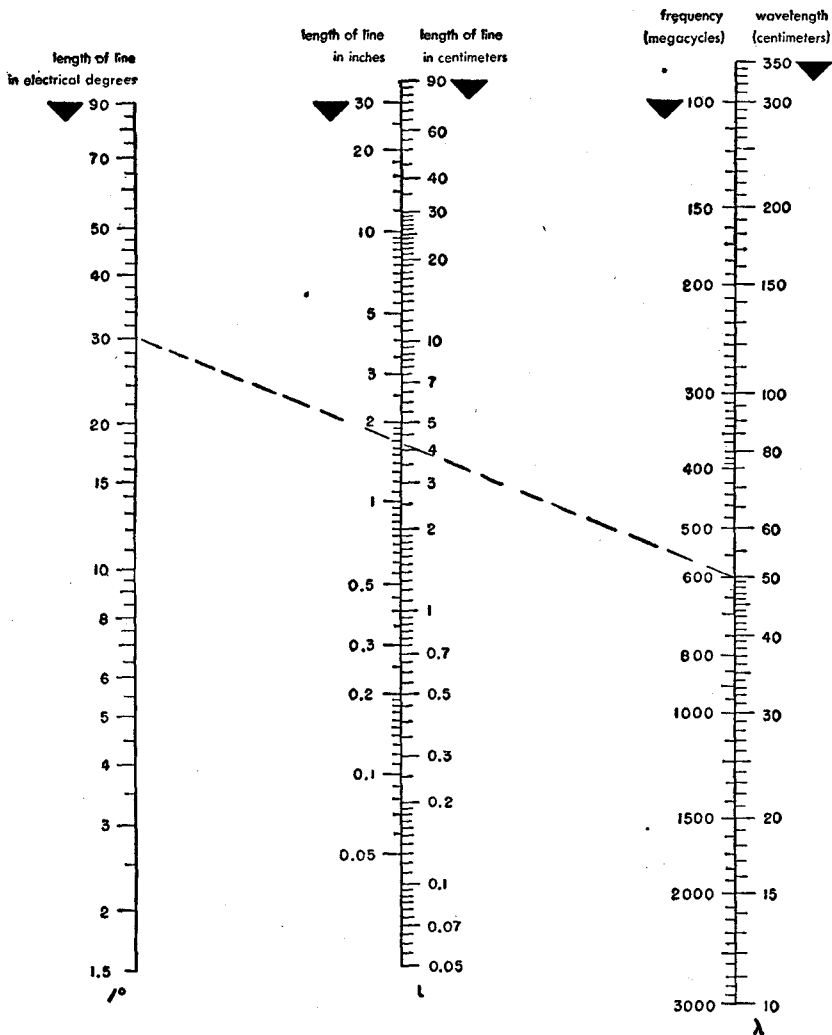

This chart gives the actual length of line in centimeters and inches when given the length in electrical degrees and the frequency provided the velocity of propagation on the transmission line is equal to that in free space. The length is given on the L scale intersection by a line between λ and l° where $l^\circ = \frac{360 L \text{ in centimeters}}{\lambda}$

Example: $f = 600$ megacycles $l^\circ = 30$ Length $L = 1.64$ inches or 4.2 centimeters

Attenuation and resistance of transmission**lines at ultra-high frequencies**

$$A = 4.35 \frac{R_t}{Z_0} + 2.78 \sqrt{\epsilon} \rho F$$

where

A = attenuation in decibels per 100 feet

R_t = total line resistance in ohms per 100 feet

ρ = power factor of dielectric medium

F = frequency in megacycles

$$R_t = 0.1 \left(\frac{1}{d} + \frac{1}{D} \right) \sqrt{F} \quad \text{for coaxial copper line}$$

$$= \frac{0.2}{d} \sqrt{F} \quad \text{for open two-wire copper line}$$

where

d = diameter of conductors (center conductor for the coaxial line) in inches

D = diameter of inner surface of outer coaxial conductor in inches

■ Wave guides and resonators

Propagation of electromagnetic waves in hollow wave guides

For propagation of energy at ultra-high frequencies through a hollow metal tube under fixed conditions, a number of different types of waves are available, namely:

1. TE waves: Transverse electric waves, sometimes called H waves, characterized by the fact that the electric vector (E vector) is always perpendicular to the direction of propagation. This means that

$$E_x = 0$$

where x is the direction of propagation.

2. TM waves: Transverse magnetic waves, also called E waves, characterized by the fact that the magnetic vector (H vector) is always perpendicular to the direction of propagation.

This means that

$$H_x = 0$$

where x is the direction of propagation.

Note: TEM waves: Transverse electromagnetic waves. These waves are characterized by the fact that both the electric vector (E vector) and the magnetic vector (H vector) are perpendicular to the direction of propagation. This means that

$$E_x = H_x = 0$$

where x is the direction of propagation. This is the mode commonly excited in coaxial and open-wire lines. It cannot be propagated in a wave guide.

The solutions for the field configurations in wave guides are characterized by the presence of the integers m and n which can take on separate values from 0 or 1 to infinity. Only a limited number of these different m, n modes can be propagated, depending on the dimensions of the guide and the frequency of excitation. For each mode there is a definite lower limit or cutoff frequency below which the wave is incapable of being propagated. Thus, a wave guide is seen to exhibit definite properties of a high-pass filter.

The propagation constant $\gamma_{n,m}$ determines the amplitude and phase of each component of the wave as it is propagated along the length of the guide. With x the direction of propagation and ω equal to 2π times the frequency, the factor for each component is

$$e^{j\omega t - \gamma_{n,m}x}$$

Propagation of electromagnetic waves in hollow wave guides continued

Thus, if $\gamma_{n,m}$ is real, the phase of each component is constant, but the amplitude decreases exponentially with x . When $\gamma_{n,m}$ is real, it is said that no propagation takes place. The frequency is considered below cutoff. Actually, propagation with high attenuation does take place for a small distance, and a short length of guide below cut-off is often used as a calibrated attenuator.

When $\gamma_{n,m}$ is imaginary, the amplitude of each component remains constant, but the phase varies with x . Hence, propagation takes place. $\gamma_{n,m}$ is a pure imaginary only in a lossless guide. In the practical case, $\gamma_{n,m}$ usually comprises both a real part, which is the attenuation constant, and an imaginary part, which is the phase propagation constant.

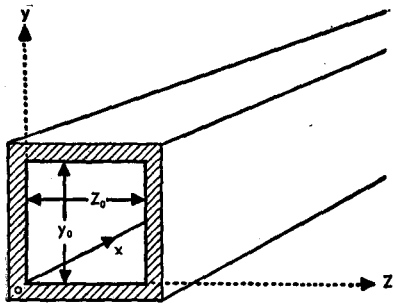

Fig. 1—Rectangular wave guide.

Rectangular wave guides

Fig. 1 shows a rectangular wave guide and a rectangular system of coordinates, disposed so that the origin falls on one of the corners of the wave guide; x is the direction of propagation along the guide, and the cross-sectional dimensions are y_0 and z_0 .

For the case of perfect conductivity of the guide walls with a non-conducting interior dielectric (usually air), the equations for the $TM_{n,m}$ or $E_{n,m}$ waves in the dielectric are:

$$E_x = A \sin\left(\frac{n\pi}{y_0} y\right) \sin\left(\frac{m\pi}{z_0} z\right) e^{j\omega t - \gamma_{n,m} x}$$

$$E_y = -A \frac{\gamma_{n,m}}{\gamma_{n,m}^2 + \omega^2 \mu_k \epsilon_k} \left(\frac{n\pi}{y_0}\right) \cos\left(\frac{n\pi}{y_0} y\right) \sin\left(\frac{m\pi}{z_0} z\right) e^{j\omega t - \gamma_{n,m} x}$$

$$E_z = -A \frac{\gamma_{n,m}}{\gamma_{n,m}^2 + \omega^2 \mu_k \epsilon_k} \left(\frac{m\pi}{z_0}\right) \sin\left(\frac{n\pi}{y_0} y\right) \cos\left(\frac{m\pi}{z_0} z\right) e^{j\omega t - \gamma_{n,m} x}$$

$$H_x = 0$$

$$H_y = A \frac{j\omega \epsilon_k}{\gamma_{n,m}^2 + \omega^2 \mu_k \epsilon_k} \left(\frac{m\pi}{z_0}\right) \sin\left(\frac{n\pi}{y_0} y\right) \cos\left(\frac{m\pi}{z_0} z\right) e^{j\omega t - \gamma_{n,m} x}$$

$$H_z = -A \frac{j\omega \epsilon_k}{\gamma_{n,m}^2 + \omega^2 \mu_k \epsilon_k} \left(\frac{n\pi}{y_0}\right) \cos\left(\frac{n\pi}{y_0} y\right) \sin\left(\frac{m\pi}{z_0} z\right) e^{j\omega t - \gamma_{n,m} x}$$

where ϵ_k is the dielectric constant and μ_k the permeability of the dielectric material in MKS (rationalized) units.

Rectangular wave guides *continued*

Constant A is determined solely by the exciting voltage. It has both amplitude and phase. Integers m and n may individually take on values from 1 to infinity. No TM waves of the 0,0 type or 0,1 type are possible in a rectangular guide so that neither m nor n may be 0.

Equations for the $TE_{n,m}$ waves or $H_{n,m}$ waves in a dielectric are:

$$H_x = B \cos\left(\frac{n\pi}{y_0} y\right) \cos\left(\frac{m\pi}{z_0} z\right) e^{j\omega t - \gamma_{n,m} x}$$

$$H_y = B \frac{\gamma_{n,m}}{\gamma_{n,m}^2 + \omega^2 \mu_k \epsilon_k} \left(\frac{n\pi}{y_0}\right) \sin\left(\frac{n\pi}{y_0} y\right) \cos\left(\frac{m\pi}{z_0} z\right) e^{j\omega t - \gamma_{n,m} x}$$

$$H_z = B \frac{\gamma_{n,m}}{\gamma_{n,m}^2 + \omega^2 \mu_k \epsilon_k} \left(\frac{m\pi}{z_0}\right) \cos\left(\frac{n\pi}{y_0} y\right) \sin\left(\frac{m\pi}{z_0} z\right) e^{j\omega t - \gamma_{n,m} x}$$

$$E_x = 0$$

$$E_y = B \frac{j\omega \mu_k}{\gamma_{n,m}^2 + \omega^2 \mu_k \epsilon_k} \left(\frac{m\pi}{z_0}\right) \cos\left(\frac{n\pi}{y_0} y\right) \sin\left(\frac{m\pi}{z_0} z\right) e^{j\omega t - \gamma_{n,m} x}$$

$$E_z = -B \frac{j\omega \mu_k}{\gamma_{n,m}^2 + \omega^2 \mu_k \epsilon_k} \left(\frac{n\pi}{y_0}\right) \sin\left(\frac{n\pi}{y_0} y\right) \cos\left(\frac{m\pi}{z_0} z\right) e^{j\omega t - \gamma_{n,m} x}$$

where ϵ_k is the dielectric constant and μ_k the permeability of the dielectric material in MKS (rationalized) units.

Constant B again depends only on the original exciting voltage and has both magnitude and phase; m and n individually may assume any integer value from 0 to infinity. The 0,0 type of wave where both m and n are 0 is not possible, but all other combinations are.

As stated previously, propagation only takes place when $\gamma_{n,m}$ the propagation constant is imaginary;

$$\gamma_{n,m} = \sqrt{\left(\frac{n\pi}{y_0}\right)^2 + \left(\frac{m\pi}{z_0}\right)^2 - \omega^2 \mu_k \epsilon_k}$$

This means, for any n,m mode, propagation takes place when

$$\omega^2 \mu_k \epsilon_k > \left(\frac{n\pi}{y_0}\right)^2 + \left(\frac{m\pi}{z_0}\right)^2$$

or, in terms of frequency f and velocity of light c , when

$$f > \frac{c}{2\pi \sqrt{\mu_1 \epsilon_1}} \sqrt{\left(\frac{n\pi}{y_0}\right)^2 + \left(\frac{m\pi}{z_0}\right)^2}$$

where μ_1 and ϵ_1 are the relative permeability and relative dielectric constant, respectively, of the dielectric material with respect to free space.

Rectangular wave guides continued

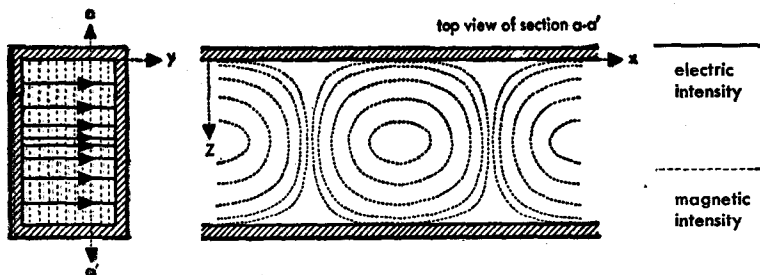

Fig. 2—Field configuration for $TE_{0,1}$ wave.

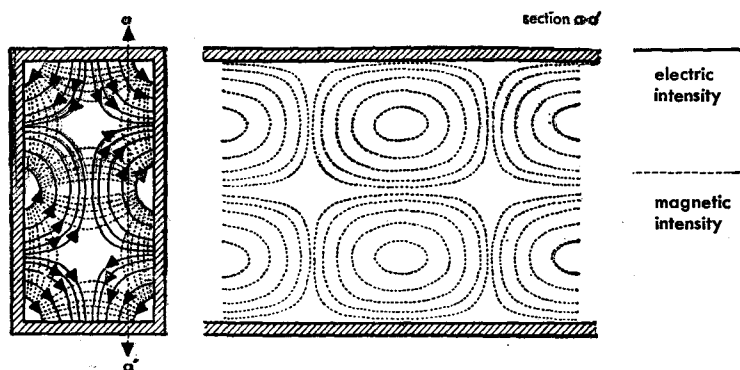

Fig. 3—Field configuration for a $TE_{1,2}$ wave.

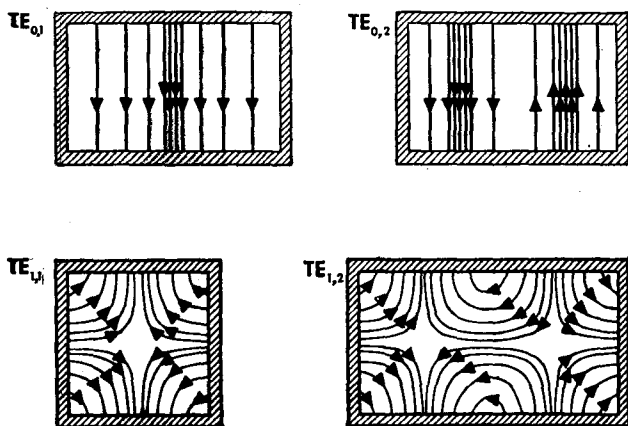

Fig. 4—Characteristic E lines for TE waves.

Rectangular wave guides *continued*

The wavelength in the wave guide is always greater than the wavelength in an unbounded medium. If λ is the wavelength in free space, the wavelength in the guide with air as a dielectric for the n, m mode is

$$\lambda_{g(n,m)} = \frac{\lambda}{\sqrt{1 - \left(\frac{n\lambda}{2y_0}\right)^2 - \left(\frac{m\lambda}{2z_0}\right)^2}}$$

The phase velocity within the guide is also always greater than in an unbounded medium. The phase velocity v and group velocity u are related by the following equation:

$$u = \frac{c^2}{v}$$

where the phase velocity is given by $v = c \frac{\lambda_g}{\lambda}$ and the group velocity is the velocity of propagation of the energy.

To couple energy into wave guides, it is necessary to understand the configuration of the characteristic electric and magnetic lines. Fig. 2 illustrates the field configuration for a $TE_{0,1}$ wave. Fig. 3 shows the instantaneous field configuration for a higher mode, a $TE_{1,2}$ wave.

In Fig. 4 are shown only the characteristic E lines for the $TE_{0,1}$, $TE_{0,2}$, $TE_{1,1}$ and $TE_{1,2}$ waves. The arrows on the lines indicate their instantaneous relative directions. In order to excite a TE wave, it is necessary to insert a probe to coincide with the direction of the E lines. Thus, for a $TE_{0,1}$ wave, a single probe projecting from the side of the guide parallel to the E lines would be sufficient to couple into it. Several means of coupling from a coaxial line to a rectangular wave guide to excite the $TE_{0,1}$ mode are shown in Fig. 5. With structures such as these, it is possible to make the standing wave ratio due to the junction less than 1.15 over a 10 to 15 percent frequency band.

Fig. 6 shows the instantaneous configuration of a $TM_{1,1}$ wave; Fig. 7, an instantaneous field configuration for a $TM_{1,2}$ wave. Coupling to this type of wave is accomplished by inserting a probe, which is again parallel to the E lines. Since the E lines in this case extend along the length of the tube, it is necessary to position a probe along its length at the center of the E configuration. Fig. 8 illustrates a method of coupling to an $E_{1,1}$ wave and an $E_{1,2}$ wave.

Rectangular wave guides *continued*

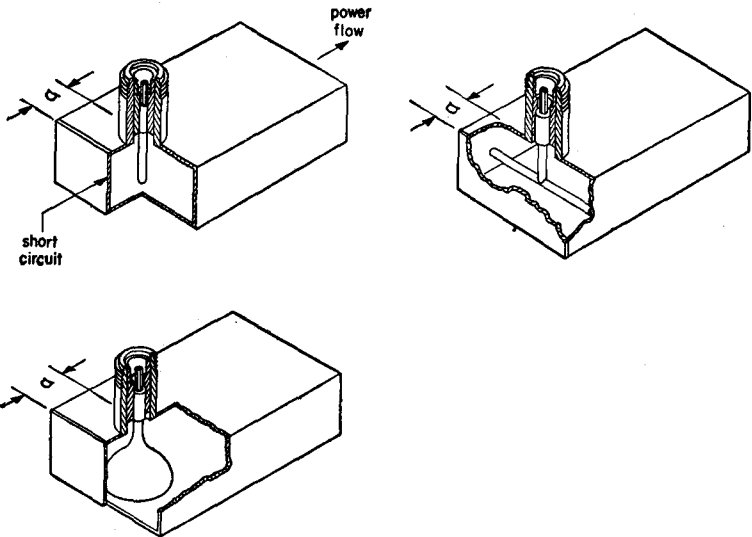

Fig. 5—Methods of coupling to $TE_{0,1}$ mode ($a \approx \lambda g/4$).



Fig. 6—Instantaneous field configuration for a $TM_{1,1}$ wave.

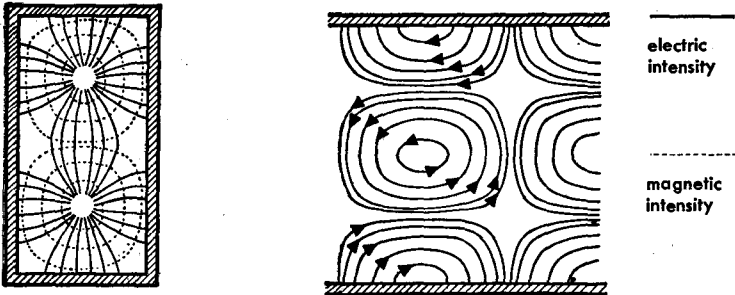

Fig. 7—Instantaneous field configuration for a $TM_{1,2}$ wave.

Rectangular wave guides *continued*

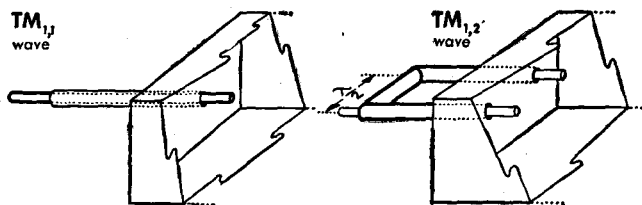

Fig. 8—Methods of coupling to rectangular wave guides for TM(E) modes.

Circular wave guides

The usual co-ordinate system is ρ, θ, z , where ρ is in radial direction; θ is the angle; z is in the longitudinal direction.

TM waves (E waves) $H_z \equiv 0$

$$E_z = A J_n(k_{n,m} \rho) \cos n \theta e^{j\omega t - \gamma_{n,m} z}$$

By the boundary conditions, $E_z = 0$ when $\rho = a$, the radius. Thus, the only permissible values of k are those for which $J_n(k_{n,m} a) = 0$ because E_z must be zero at the boundary.

The numbers m, n take on all integral values from zero to infinity. The waves are seen to be characterized by two numbers, m and n , where n gives the order of the Bessel functions, and m gives the order of the root of $J_n(k_{n,m} a)$. The Bessel function has an infinite number of roots, so that there are an infinite number of k 's which make $J_n(k_{n,m} a) = 0$.

The other components of the electric vector E_θ and E_ρ are related to E_z as are H_θ and H_ρ .

TE waves (H waves) $E_z \equiv 0$

$$H_z = B J_n(k_{n,m} \rho) \cos n \theta e^{j\omega t - \gamma_{n,m} z}$$

$H_\rho, H_\theta, E_\rho, E_\theta$ are all related to H_z .

Circular wave guides *continued*

Again n takes on integral values from zero to infinity. The boundary condition $E_z = 0$ when $\rho = a$ still applies. To satisfy this condition k must be such as to make $J'_n(k_{n,m} a)$ equal to zero where the superscript indicates the derivative of $J_n(k_{n,m} a)$. It is seen that m takes on values from 1 to infinity since there are an infinite number of roots of $J'_n(k_{n,m} a)$.

For circular wave guides, the cut-off frequency for the m, n mode is $f_{c, n, m} = \frac{c k_{n, m}}{2 \pi}$ where $c =$ velocity of light and $k_{n, m}$ is evaluated from the roots of the Bessel functions

and

$k_{n, m} = \frac{U_{n, m}}{a}$ or $\frac{U'_{n, m}}{a}$ where $a =$ radius of guide or pipe and $U_{n, m}$ is the root of the particular Bessel function of interest (or its derivative).

The wavelength in the guide is

$$\lambda_g = \frac{2 \pi}{\sqrt{\left(\frac{2 \pi}{\lambda_0}\right)^2 - k_{n, m}^2}} \quad \text{where } \lambda_0 \text{ is the wavelength in an unbounded medium.}$$

The following tables are useful in determining the values of k . For H waves the roots $U'_{n, m}$ of $J'_n(U) = 0$ are given in the following table, and the corresponding $k_{n, m}$ values are $\frac{U'_{n, m}}{a}$

Values of $U'_{n, m}$

$m \backslash n$	0	1	2
1	3.832	1.841	3.054
2	7.016	5.332	6.705
3	10.173	8.536	9.965

For E waves the roots $U_{n, m}$ of $J_n(U) = 0$ are given in the following table, and the corresponding $k_{n, m}$ values are $\frac{U_{n, m}}{a}$

Values of $U_{n, m}$

$m \backslash n$	0	1	2
1	2.405	3.832	5.135
2	5.520	7.016	8.417
3	8.654	10.173	11.620

where n is the order of the Bessel function and m is the order of the root.

Circular wave guides *continued*

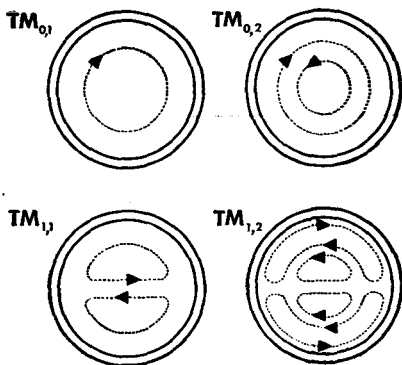

Fig. 9
Patterns of magnetic force of TM waves in circular wave guides.

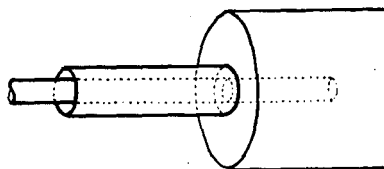

Fig. 10
Method of coupling to circular wave guide for $TM_{0,1}$ wave.

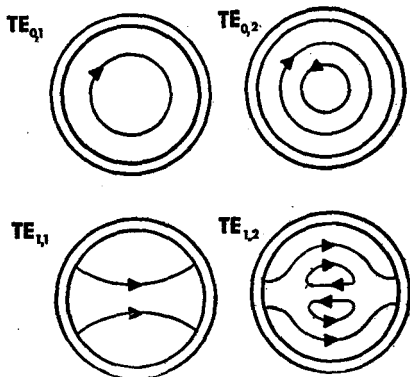

Fig. 11
Patterns of electric force of TE waves in circular wave guides.

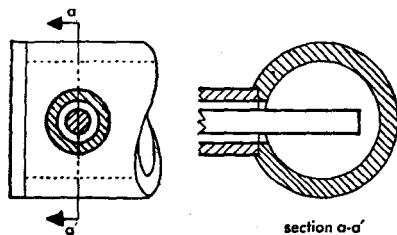

Fig. 12
Method of coupling to circular wave guide for $TE_{1,1}$ wave.

Table I—Cut-off wavelengths and attenuation factors

	coaxial cable (a, b)	rectangular pipe a, b TE _{0,m} or H _{0,m}	TM _{0,1} or E ₀	circular pipe of radius a TE _{1,1} or H ₁	TE _{0,1} or H ₀
Cut-off wavelength λ_c	0	$\frac{2b}{m}$	2.613a	3.412a	1.640a
Attenuation constant = α	$\alpha_0 \sqrt{\frac{c}{\lambda}} \frac{\left(\frac{1}{a} + \frac{1}{b}\right)}{\log \frac{b}{a}}$	$\frac{4\alpha_0}{b} A \left(\frac{b}{2a} + \frac{\lambda^2}{\lambda_c^2}\right)$	$\frac{2\alpha_0}{a} A$	$\frac{2\alpha_0}{a} A \left(0.415 + \frac{\lambda^2}{\lambda_c^2}\right)$	$\frac{2\alpha_0}{a} A \left(\frac{\lambda}{\lambda_c}\right)^2$

where

 λ_c = cut-off wavelength

$$A = \frac{\sqrt{c/\lambda}}{\sqrt{1 - \left(\frac{\lambda}{\lambda_c}\right)^2}}, \quad \alpha_0 = \frac{1}{4} \sqrt{\frac{\mu_2 \epsilon_1}{\sigma_2 \mu_1}} \quad (\text{emu})$$

Circular wave guides *continued*

The pattern of magnetic force of TM waves in a circular wave guide is shown in Fig. 9. Only the maximum lines are indicated. In order to excite this type of pattern, it is necessary to insert a probe along the length of the wave guide concentric with the H lines. For instance, in the $TM_{0,1}$ type of wave, a probe extending down the length of the wave guide at the very center of the guide would provide the proper excitation. This method of excitation is shown in Fig. 10. Similar methods of excitation may be used for the other types of TM waves shown in Fig. 9.

Fig. 11 shows the patterns of electric force for TE waves. Again only the maximum lines are indicated. This type of wave may be excited by an antenna which is parallel to the electric lines of force. For instance, the $TE_{0,1}$ wave would be excited by a small circular loop placed where the maximum E line is indicated in the diagram. The $TE_{1,1}$ wave may be excited by means of an antenna extending across the wave guide. This is illustrated in Fig. 12.

Attenuation constants

All the attenuation constants contain a common coefficient

$$\alpha_0 = \frac{1}{4} \sqrt{\frac{\mu_2 \epsilon_1}{\sigma_2 \mu_1}}$$

ϵ_1, μ_1 dielectric constant and magnetic permeability for the insulator •

σ_2, μ_2 electric conductivity and magnetic permeability for the metal

For air and copper $\alpha_0 = 0.35 \times 10^{-9}$ nepers per centimeter
or 0.3×10^{-8} db per kilometer

Table I summarizes some of the most important formulas. The dimensions a, b are measured in *centimeters*.

Electromagnetic horns

Radiation from the wave guide may be obtained by placing an electromagnetic horn of a particular size at the end of the wave guide. The characteristics for different types of circular horns are shown in Figs. 13 and 14.

Fig. 13 gives data for designing a horn to have a specified gain with the shortest length possible. The length L_1 is given by $L_1 = L \left(1 - \frac{a}{2A} - \frac{b}{2B} \right)$ where a = wide dimension of wave guide in the H plane, and b = narrow dimension of wave guide in E plane.

Electromagnetic horns *continued*

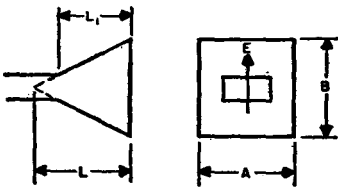
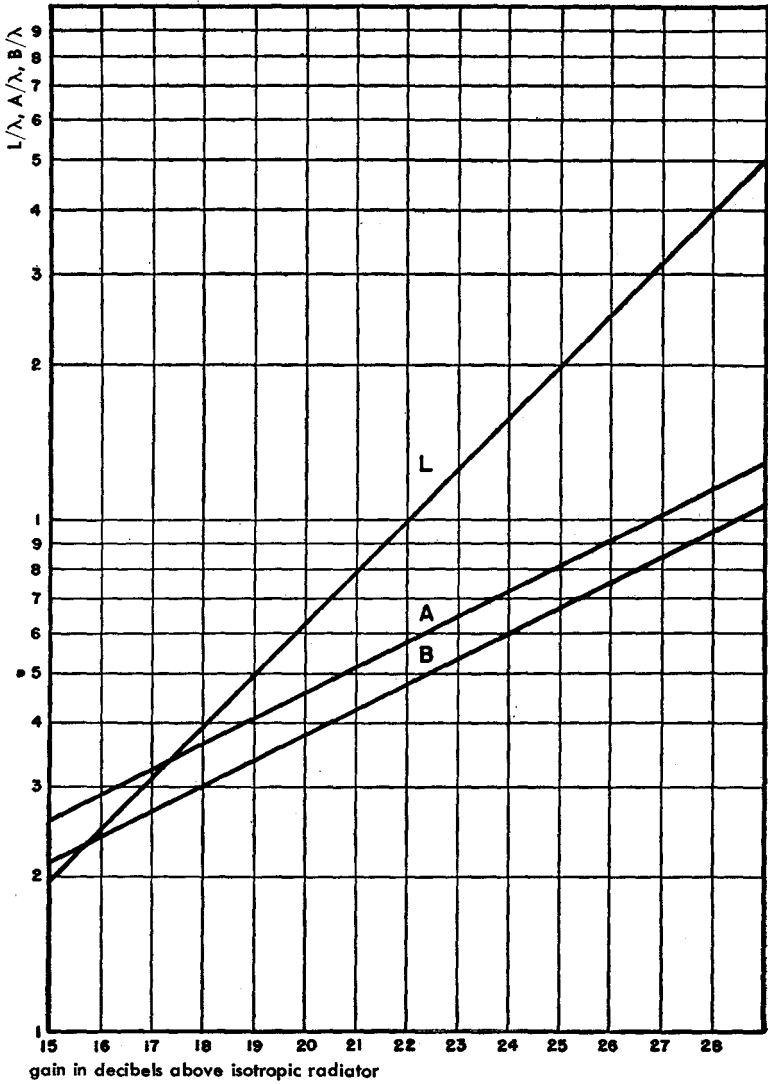

- L = axial length to apex
- A = width of aperture in H plane
- B = width of aperture in E plane

Fig. 13.

Electromagnetic horns *continued*

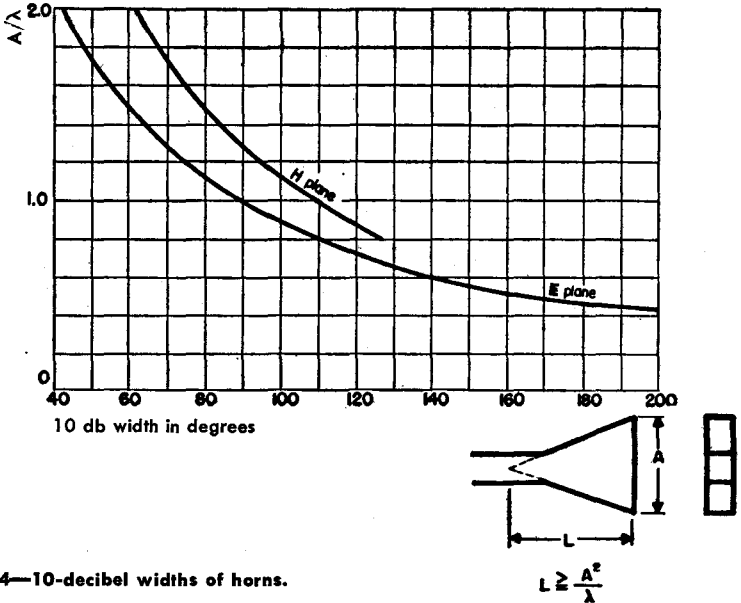

Fig. 14—10-decibel widths of horns.

If $L \geq \frac{a^2}{\lambda}$ (a = longer dimension of aperture) the gain is given by $G = \frac{10ab}{\lambda^2}$, the half power width in the E plane is given by $51^\circ \frac{\lambda}{b}$, and the half power width in the H plane is given by $70^\circ \frac{\lambda}{a}$, where E is the electric vector and H is the magnetic vector, Fig. 14 shows how the angle between 10-decibel points varies with aperture.

Parabolas

If the intensity across the aperture of the parabola is of constant phase and tapers smoothly from the center to the edges so that the intensity at the edges is 10 decibels down from that at the center, the gain is given by $G = \frac{8A}{\lambda^2}$ (A = area of aperture). The half power width is given by $70^\circ \frac{\lambda}{D}$ (D = diameter of parabola).

Resonant cavities

A cavity enclosed by metal walls will have an infinite number of natural frequencies at which resonance will occur. The lowest frequency or mode of oscillation is determined by the geometry of the cavity. One of the

Resonant cavities *continued*

more common types of cavity resonators is a length of transmission line (coaxial, or waveguide) short circuited at both ends.

Resonance occurs when

$$2h = l \frac{\lambda_g}{2} \text{ where } l \text{ is an integer}$$

$2h$ = length of the resonator

λ_g = guide wavelength in resonator

$$\lambda_g = \frac{\lambda}{\sqrt{1 - \left(\frac{\lambda}{\lambda_c}\right)^2}}$$

λ = free space wavelength λ_c = guide cut-off wavelength

For $TE_{n,m}$ or $TM_{n,m}$ waves in a rectangular cavity with cross section a, b .

$$\lambda_c = \frac{2}{\sqrt{\left(\frac{m}{a}\right)^2 + \left(\frac{n}{b}\right)^2}} \text{ where } m \text{ and } n \text{ are integers}$$

For $TE_{n,m}$ waves in a cylindrical cavity

$$\lambda_c = \frac{2\pi a}{U'_{n,m}}$$

where a is the guide radius and $U'_{n,m}$ is the m th root of the equation $J'_n(U) = 0$

For $TM_{n,m}$ waves in a cylindrical cavity

$$\lambda_c = \frac{2\pi a}{U_{n,m}}$$

where a is the guide radius and $U_{n,m}$ is the m th root of the equation $J_n(U) = 0$.

For TM waves $l = 0, 1, 2, \dots$

For TE waves $l = 1, 2, \dots$ but not 0

Rectangular cavity of dimensions a b $2h$

$$\lambda = \frac{2}{\sqrt{\left(\frac{l}{2h}\right)^2 + \left(\frac{m}{a}\right)^2 + \left(\frac{n}{b}\right)^2}} \text{ where only one of } l, m, n \text{ may be zero.}$$

Resonant cavities *continued*
Cylindrical cavities of radius a and length $2h$

$$\lambda = \frac{1}{\sqrt{\left(\frac{1}{4h}\right)^2 + \left(\frac{1}{\lambda_c}\right)^2}}$$

where λ_c is the guide cut-off wavelength.

Spherical resonators of radius a

$$\lambda = \frac{2\pi a}{U_{n,m}} \text{ for a TE wave}$$

$$\lambda = \frac{2\pi a}{U'_{n,m}} \text{ for a TM wave.}$$

Values of $U_{n,m}$:

$$U_{1,1} = 4.5, U_{2,1} = 5.8, U_{1,2} = 7.64$$

Values of $U'_{n,m}$:

$$U'_{1,1} = 2.75 = \text{lowest order root}$$

Additional cavity formulas

type of cavity	mode	λ_0 resonant wavelength	Q
Right circular cylinder	$TM_{0,1,1}$ (E_0)	$\frac{4}{\sqrt{\left(\frac{1}{h}\right)^2 + \frac{2.35}{a^2}}}$	$\frac{\lambda_0}{\delta} \frac{\sigma}{\lambda_0} \frac{1}{1 + \frac{\sigma}{2h}}$
	$TE_{0,1,1}$ (H_0)	$\frac{4}{\sqrt{\left(\frac{1}{h}\right)^2 + \frac{5.93}{a^2}}}$	$\frac{\lambda_0}{\delta} \frac{\sigma}{\lambda_0} \left[\frac{1 + 0.168 \left(\frac{\sigma}{h}\right)^2}{1 + 0.168 \left(\frac{\sigma}{h}\right)^3} \right]$
	$TE_{1,1,1}$ (H_1)	$\frac{4}{\sqrt{\left(\frac{1}{h}\right)^2 + \frac{1.37}{a^2}}}$	$\frac{\lambda_0}{\delta} \frac{h}{\lambda_0} \left[\frac{2.39h^2 + 1.73a^2}{3.39 \frac{h^3}{a} + 0.73ah + 1.73a^2} \right]$

Some characteristics of various types of resonators

δ is the skin depth

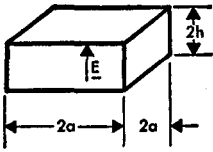
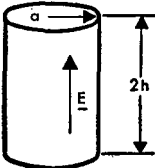
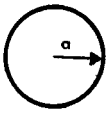
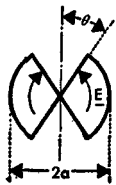
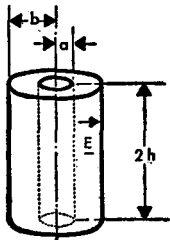
type resonator	wavelength, λ	Q
Square prism $TE_{0,1,1}$ 	$2\sqrt{2}a$	$\frac{0.353\lambda}{\delta} \frac{1}{1 + \frac{0.177\lambda}{h}}$
Circular cylinder $TM_{0,1,0}$ 	$2.61a$	$\frac{0.383\lambda}{\delta} \frac{1}{1 + \frac{0.192\lambda}{h}}$
Sphere 	$2.28a$	$0.318 \frac{\lambda}{\delta}$
Sphere with cones 	$4a$	Optimum Q for $\theta = 34^\circ$ $0.1095 \frac{\lambda}{\delta}$
Coaxial TEM 	$4h$	Optimum Q for $\frac{b}{a} = 3.6$ $(Z_0 = 77 \text{ ohms})$ $\frac{\lambda}{4\delta + 7.2 \frac{h\delta}{b}}$

$\delta = \sqrt{\frac{\rho}{2\pi\omega\mu}}$ where ρ = resistivity of wall in abohm-cm, μ = permeability of volume (unity for free space), δ = skin depth in centimeters.

Recommended rectangular wave guides

dimension inches	A-N number	cutoff wavelength λ_c (centimeters)	usable wavelength range for TE ₁₀ , 1 mode (centimeters)	connectors		attenuation in brass wave guide db/ft
				choke	flange	
1½ × 3 × 0.081 wall	RG-48/U	14.4	7.6-11.8	UG-54/U	UG-53/U	0.012 @ 10 cm
1 × 2 × 0.064 wall	RG-49/U	9.5	5.0-7.6	UG-148/U	UG-149/U	0.021 @ 6 cm
¾ × 1½ × 0.064 wall	RG-50/U	6.97	3.7-5.7	UG-150/U	contact type	0.036 @ 5 cm
⅝ × 1¼ × 0.064 wall	RG-51/U	5.7	3.0-4.7	UG-52/U	UG-51/U	0.050 @ 3.6 cm
½ × 1 × 0.050 wall	RG-52/U	4.57	2.4-3.7	UG-40/U	UG-39/U	0.076 @ 3.2 cm

■ Radio propagation and noise

Propagation of medium and long waves*

For a theoretical short vertical antenna over perfect ground:

$$E = 186 \sqrt{P_r} \text{ millivolts per meter at 1 mile}$$

or,

$$E = 300 \sqrt{P_r} \text{ millivolts per meter at 1 kilometer}$$

where P_r = radiated power in kilowatts.

Actual inverse-distance fields at one mile for a given transmitter output power depend on the height and efficiency of the antenna and the efficiency of coupling devices.

Typical values found in practice for well-designed stations are:

Small L or T antennas as on ships; $25 \sqrt{P_t}$ millivolts per meter at 1 mile

Vertical radiators 0.15 to 0.25 λ high; $150 \sqrt{P_t}$ millivolts per meter at 1 mile

Vertical radiators 0.25 to 0.40 λ high; $175 \sqrt{P_t}$ millivolts per meter at 1 mile

Vertical radiators 0.40 to 0.60 λ high or top-loaded vertical radiators; $220 \sqrt{P_t}$ millivolts per meter at 1 mile,

where P_t = transmitter output power in kilowatts.

These values can be increased by directive arrangements.

The surface-wave field (commonly called *ground wave*) at greater distances can be found from Figs. 1, 2, and 3. These are based on a field strength of 186 millivolts per meter at one mile. The ordinates should be multiplied by the ratio of the actual field at 1 mile to 186 millivolts per meter.

Table I—Ground conductivities and dielectric constants

terrain	σ conductivity emu	ϵ dielectric constant esu
Sea water	4×10^{-11}	80
Fresh water	5×10^{-14}	80
Dry, sandy flat coastal land	2×10^{-14}	10
Marshy, forested flat land	8×10^{-14}	12
Rich agricultural land, low hills	1×10^{-13}	15
Pastoral land, medium hills and forestation	5×10^{-14}	13
Rocky land, steep hills	2×10^{-14}	10
Mountainous (hills up to 3000 feet)	1×10^{-14}	5
Cities, residential areas	2×10^{-14}	5
Cities, industrial areas	1×10^{-15}	3

Note: This table for use for medium- and long-wave propagation with Norton's, van der Pol's, Eckersley's, or other developments of Sommerfeld propagation formulas.

* For more exact methods of computation see Terman, F. E., *Radio Engineers' Handbook*. Sec. 10; or Norton, K. A., *The Calculation of Ground-wave Field Intensities Over a Finitely Conducting Spherical Earth*. Proc. I.R.E., vol. 29, p. 623 (December, 1941).

Propagation of medium and long waves *continued*

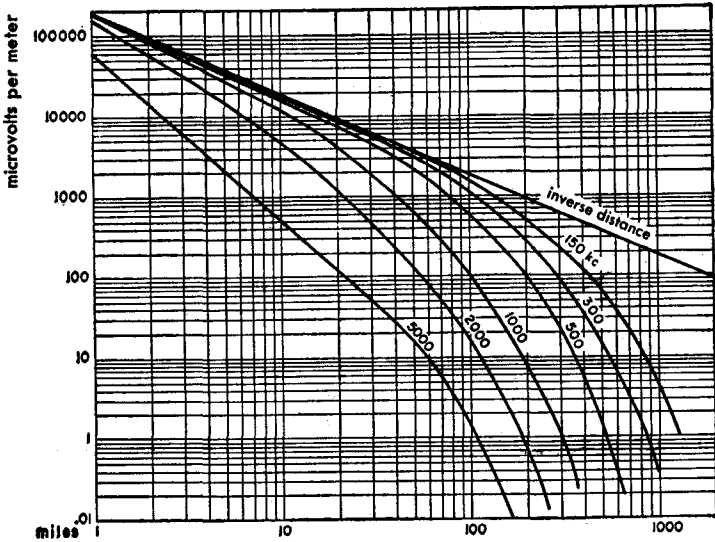

Fig. 1—Strength of surface waves as a function of distance with a vertical antenna for good earth ($\sigma = 10^{-13}$ emu and $\epsilon = 15$ esu).

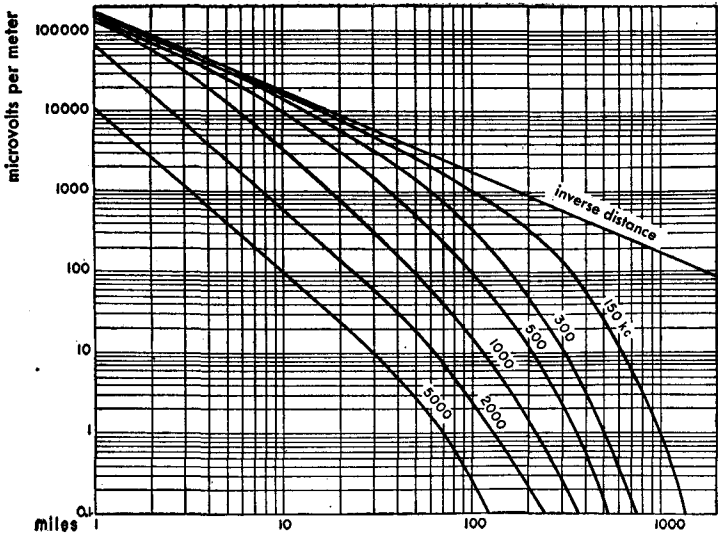

Fig. 2—Strength of surface waves as a function of distance with a vertical antenna for poor earth ($\sigma = 2 \times 10^{-14}$ emu and $\epsilon = 5$ esu).

Propagation of medium and long waves *continued*

Figs. 1, 2, and 3 do not include the effect of sky waves reflected from the ionosphere. Sky waves cause fading at medium distances and produce higher field intensities than the surface wave at longer distances, particularly at night and on the lower frequencies during the day. Sky-wave field intensity, in addition to the usual diurnal, seasonal, and irregular variations due to changing properties of the ionosphere, depends on frequency and the vertical radiation pattern of the antenna. Fig. 4 shows the average of night-time measurements on a number of broadcast stations for about 1-kilowatt output.



Fig. 3—Strength of surface waves as a function of distance with a vertical antenna for sea water ($\sigma = 4 \times 10^{-11}$ emu and $\epsilon = 80$ esu).

Propagation of short waves

At frequencies between about 3 and 25 megacycles and distances greater than about 100 miles, transmission depends entirely on sky waves reflected from the ionosphere. The ionosphere (a region high above the earth's surface where the rarefied air is sufficiently ionized to reflect or absorb radio waves) is usually considered as consisting of the following layers.

D layer: At heights from about 50 to 90 kilometers, it exists only during day-light hours and ionization density corresponds with the altitude of the sun.

Propagation of short waves *continued*

This layer reflects low- and medium-frequency waves and weakens high-frequency waves through partial absorption.

E layer: At height of about 110 kilometers, this layer is of importance for shortwave daytime propagation at distances less than 1000 miles and for medium wave nighttime propagation at distances in excess of about 100 miles. Ionization density corresponds closely with the altitude of the sun. Irregular cloud-like areas of unusually high ionization, called *sporadic E* may occur up to more than 50 percent of the time on certain days or nights. *Sporadic E* occasionally prevents frequencies that normally penetrate the E layer reaching higher layers and also causes occasional long-distance transmission at very high frequencies.

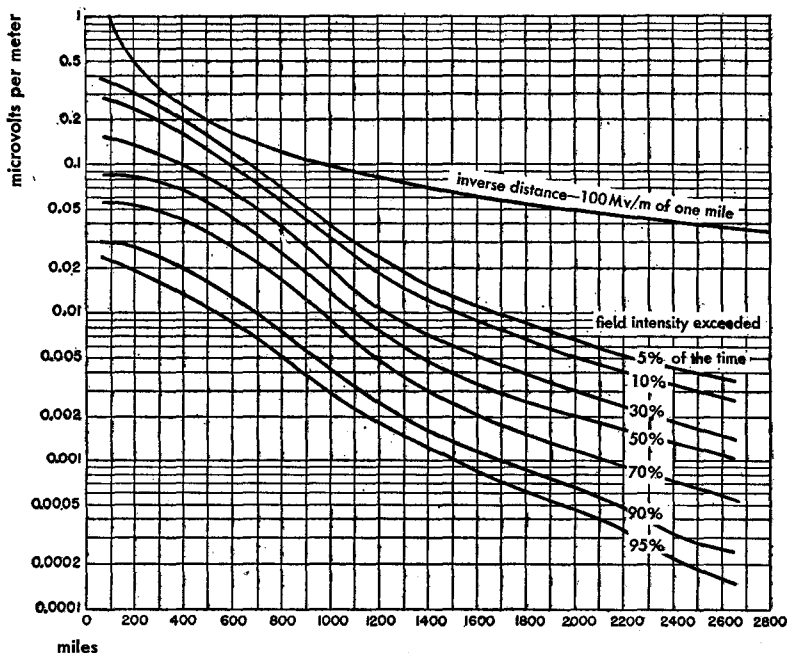

Fig. 4—Average sky-wave field intensity (corresponding to the second hour after sunset at the recording station).

F₁ layer: At heights of about 175 to 250 kilometers, it exists only during daylight. This layer occasionally is the reflecting region for shortwave transmission, but usually oblique incidence waves that penetrate the E layer also penetrate the F₁ layer to be reflected by the F₂ layer. The F₁ layer introduces additional absorption of such waves.

Propagation of short waves *continued*

F₂ layer: At heights of about 250 to 400 kilometers, F₂ is the principal reflecting region for long-distance shortwave communication. Height and ionization density vary diurnally, seasonally, and over the sunspot cycle. Ionization does not correspond closely to the altitude of the sun. At night, the F₁ layer merges with the F₂ layer at a height of about 300 kilometers. The absence of the F₁ layer, and reduction in absorption of the E layer, causes nighttime field intensities and noise to be generally higher than during daylight hours.

As indicated to the right on Fig. 6, these layers are contained in a thick region throughout which ionization generally increases with height. The layers are said to exist where the ionization gradient is capable of refracting waves back to earth. Obliquely incident waves follow a curved path through the ionosphere due to gradual refraction or bending of the wave front.

Depending on the ionization density at each layer, there is a *critical* or highest frequency f_c at which the layer reflects a vertically incident wave. Frequencies higher than f_c pass through the layer at vertical incidence. At oblique incidence the layer reflects frequencies higher than f_c as given by the approximate relation:

$$muf = f_c \sec \phi$$

where muf = maximum usable frequency for the particular layer and distance,
 ϕ = angle of incidence at reflecting layer.

f_c and height, and hence ϕ for a given distance, for each layer vary with local time of day, season, latitude, and throughout the eleven-year sunspot cycle. The various layers change in different ways with these parameters. In addition, ionization is subject to frequent abnormal variations.

The loss at reflection for each layer is a minimum at the maximum usable frequency and increases rapidly for frequencies lower than maximum usable frequency.

Short waves travel from the transmitter to the receiver by reflections from the ionosphere and earth in one or more hops as indicated in Figs. 5 and 6. Additional reflections may occur along the path between the bottom edge of a higher layer and the top edge of a lower layer, the wave finally returning to earth near the receiver.

Fig. 5 illustrates single-hop transmission, Washington to Chicago, via the E layer (ϕ_1). At higher frequencies over the same distance, single-hop transmission would be obtained via the F₂ layer (ϕ_2). Fig. 5 also shows two-hop transmission, Washington to San Francisco, via the F₂ layer (ϕ_3). Fig. 6 indicates transmission on a common frequency, (1.) single-hop via E layer, Denver to Chicago, and, (2.) single-hop via F₂, Denver to Washington, with, (3.) the wave failing to reflect at higher angles, thus producing a *skip* region of no signal between Denver and Chicago.

Propagation of short waves *continued*

Actual transmission over long distances is more complex than indicated by Figs. 5 and 6, because the layer heights and critical frequencies differ with time (and hence longitude) and with latitude. Further, scattered reflections occur at the various surfaces.

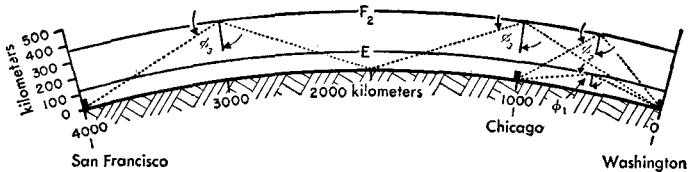

Fig. 5.

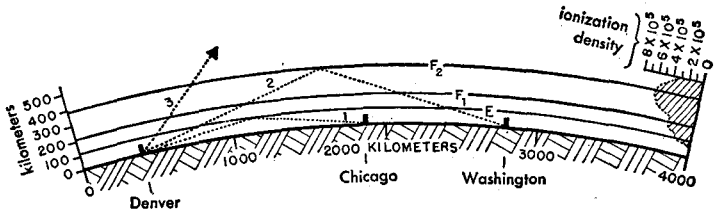

Fig. 6.

Maximum usable frequencies (muf) for single-hop transmission at various distances throughout the day are given in Fig. 7. These approximate values apply to latitude 39° N for the approximate minimum years (1944 and 1955) and approximate maximum years (1949 and 1960) of the sunspot cycle. Since the maximum usable frequency and layer heights change from month to month, the latest predictions should be obtained whenever available. This information is published by the National Bureau of Standards in the U. S. A. and by similar organizations in other countries.

Operating frequencies should be selected from 50 to 85 percent of the maximum usable frequency, preferably nearer the higher limit in order to reduce absorption loss. The 85 percent limit provides some margin for day-to-day deviation of the ionospheric characteristics from the predicted monthly average value. Maximum usable frequency changes continuously throughout the day, whereas it is ordinarily impractical to change operating frequencies correspondingly. Each operating frequency, therefore, should be selected to fall within the above limits for a substantial portion of the daily operating period.

For single-hop transmission, frequencies should be selected on the basis of local time and other conditions existing at the mid-point of the path. In view of the layer heights and the fact that practical antennas do not operate effectively below angles of about three degrees, single-hop trans-

Propagation of short waves *continued*

mission cannot be achieved for distances in excess of about 2200 miles (3500 kilometers) via F layers or in excess of about 1050 miles (1700 kilometers) via the E layer. Multiple-hop transmission must occur for longer distances and, even at distances of less than 2200 miles, the major part of the received signal frequently arrives over a two- or more-hop path. In analyzing two-hop paths, each hop is treated separately and the lowest frequency required on either hop becomes the maximum usable frequency for the circuit. It is usually impossible to predict accurately the course of radio waves on circuits involving more than two hops because of the large number of possible paths and the scattering that occurs at each reflection. For such long-distance circuits, it is customary to consider the conditions existing at points 1250 miles along the path from each end as the points at which the maximum usable frequencies should be calculated.

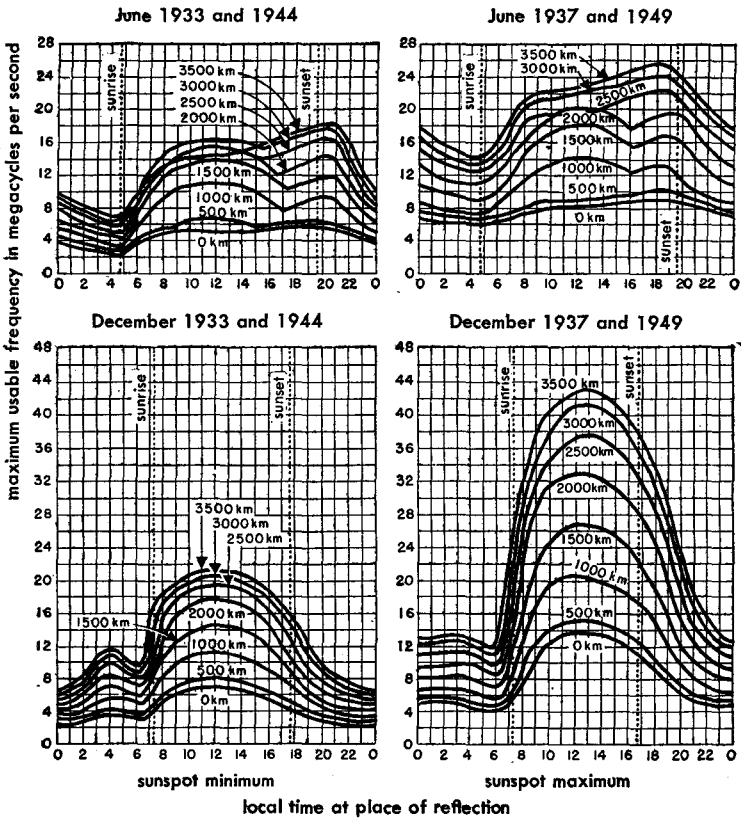

Fig. 7.

Propagation forecasts for short waves

In addition to forecasts for ionospheric disturbances, the Central Radio Propagation Laboratories of the National Bureau of Standards issues monthly *Basic Radio Propagation Predictions* 3 months in advance used to determine the optimum working frequencies for shortwave communication. Indication of the general nature of the CRPL data and a much abbreviated example of their use follows:

Example

To determine working frequencies for use between San Francisco and Wellington, N. Z.

Method

1. Place a transparent sheet over Fig. 8 and mark thereon the equator, a line across the equator showing the meridian of time desired (viz., GCT or PST), and locations of San Francisco and Wellington.
2. Transfer sheet to Fig. 9, keeping equator lines of chart and transparency aligned. Slide from left to right until terminal points marked fall along a Great Circle line. Sketch in this Great Circle between terminals and mark "control points" 2000 kilometers along this line from each end.
3. Transfer sheet to Fig. 10, showing muf for transmission via the F₂ layer. Align equator as before. Slide sheet from left to right placing meridian line on time desired and record frequency contours at control points. This illustration assumes that radio waves are propagated over this path via the F₂ layer. Eliminating all other considerations, 2 sets of frequencies, corresponding to the control points, are found as listed in Table II, the lower of which is the muf. The muf, decreased by 15 percent, gives the optimum working frequency.

Transmission may also take place via other layers. For the purpose of illustration only and without reference to the problem above, Figs. 11 and 12 have been reproduced to show characteristics of the E and sporadic E layers. The complete detailed step-by-step procedure, including special considerations in the use of this method, are contained in the complete CRPL forecasts.

Table II—Maximum usable frequency

GCT	at San Francisco control point (2000 km from San Francisco)	at Wellington, N. Z. control point (2000 km from Wellington)	optimum working frequency (lower of muf × 0.85)
0000	32.0	31.5	26.8
0400	34.2	25.0	21.0
0800	23.2	13.7	11.7
1200	18.0	14.8	12.6
1600	23.4	12.2	10.4
2000	24.6	2.88	20.9

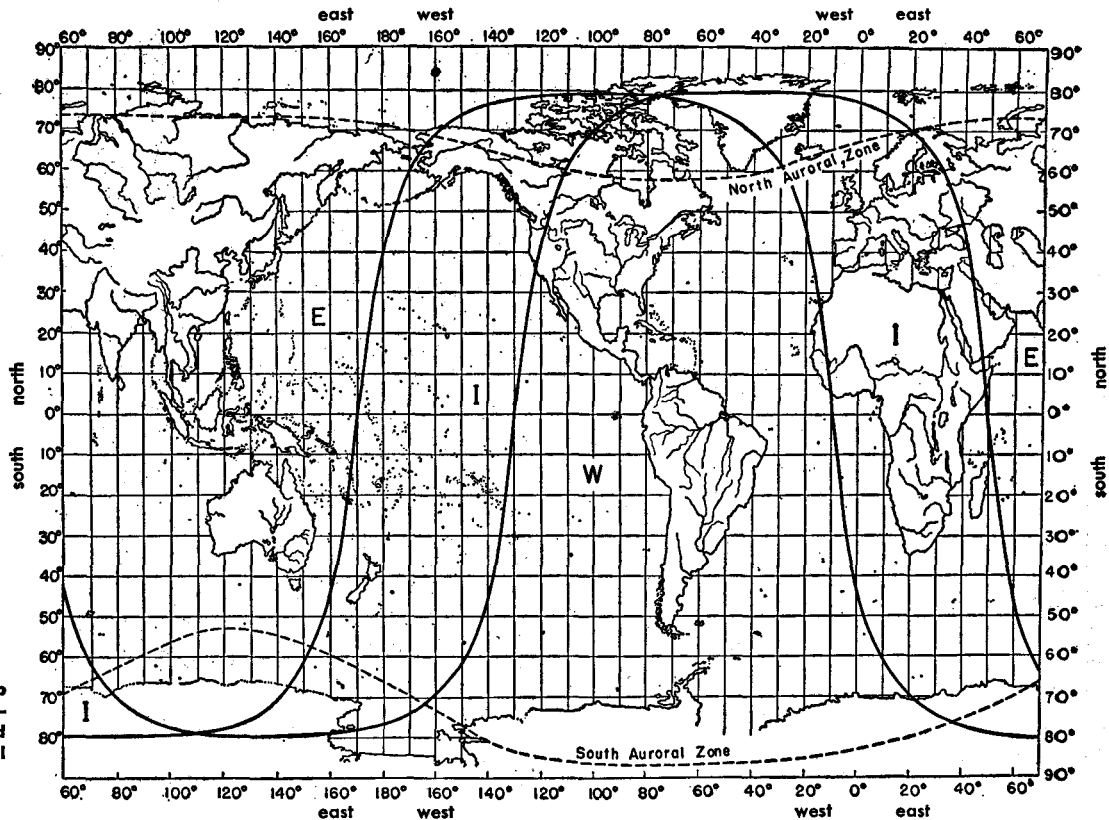

Fig. 8—World map showing zones covered by predicted charts and auroral zones.

continued

Propagation forecasts for short waves

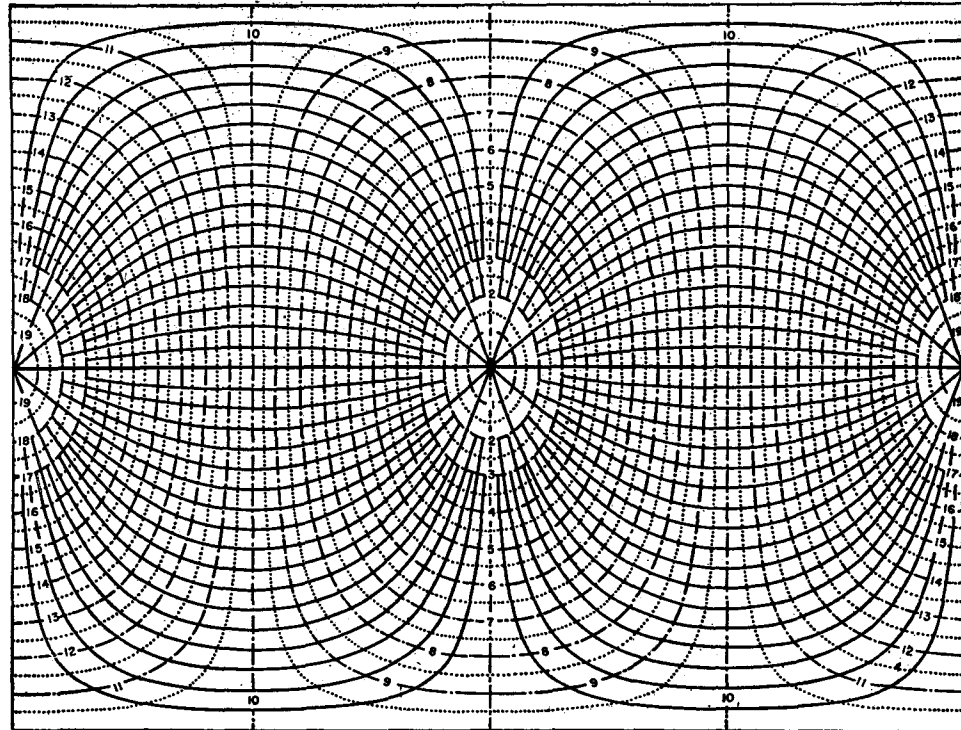

Fig. 9—Great circle chart centered on equator. Solid lines represent great circles. Dot-dash lines indicate distances in thousands of kilometers.

continued

Propagation forecasts for short waves

234

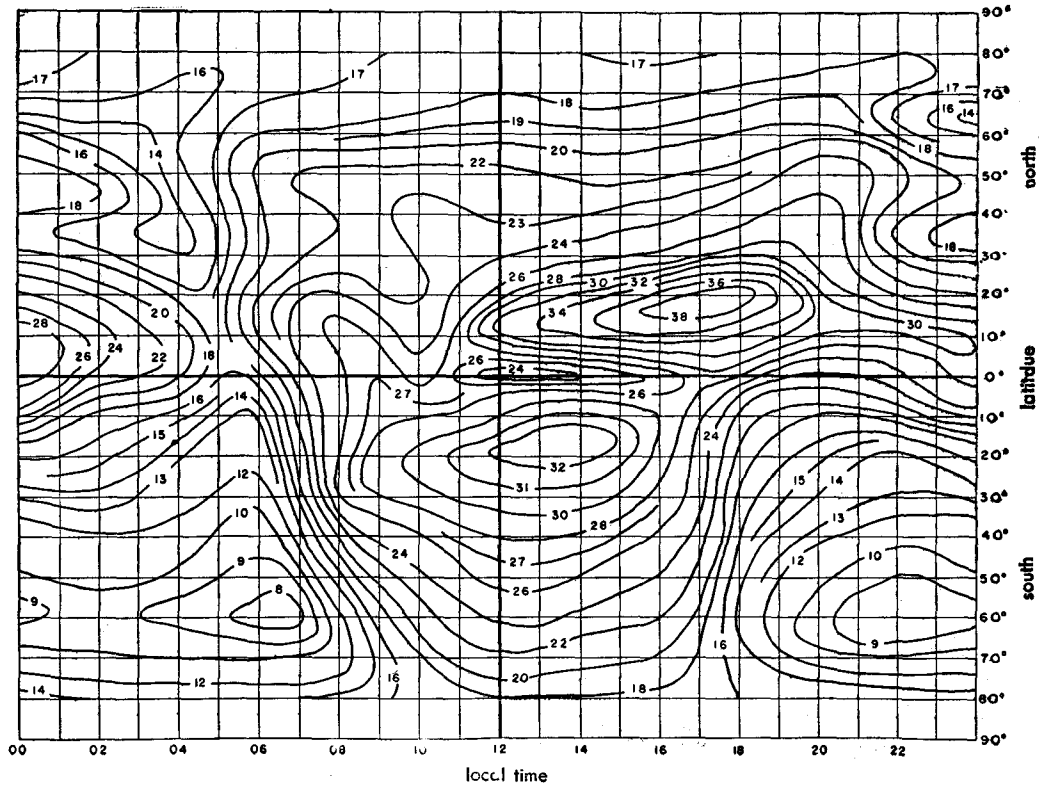

Fig. 10—F₂ 4000-kilometer maximum usable frequency in megacycles. I zone (see Fig. 8) predicted for July, 1946.

continued

Propagation forecasts for short waves

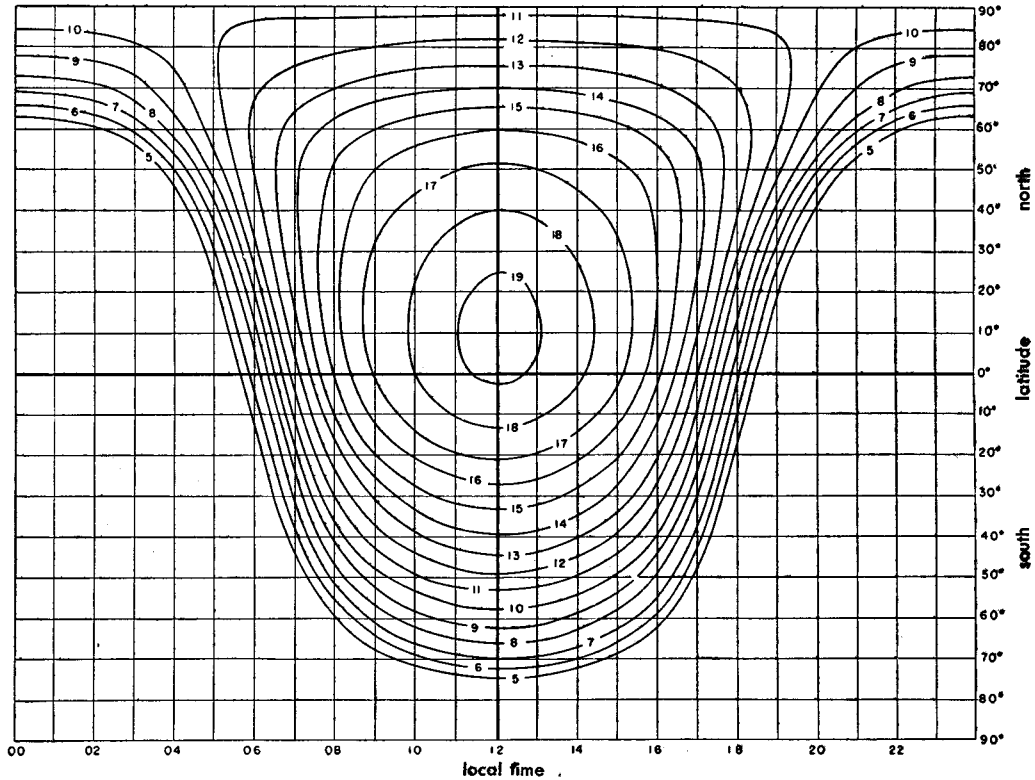

Fig. 11—E layer 2000-kilometer maximum usable frequency in megacycles predicted for July, 1946.

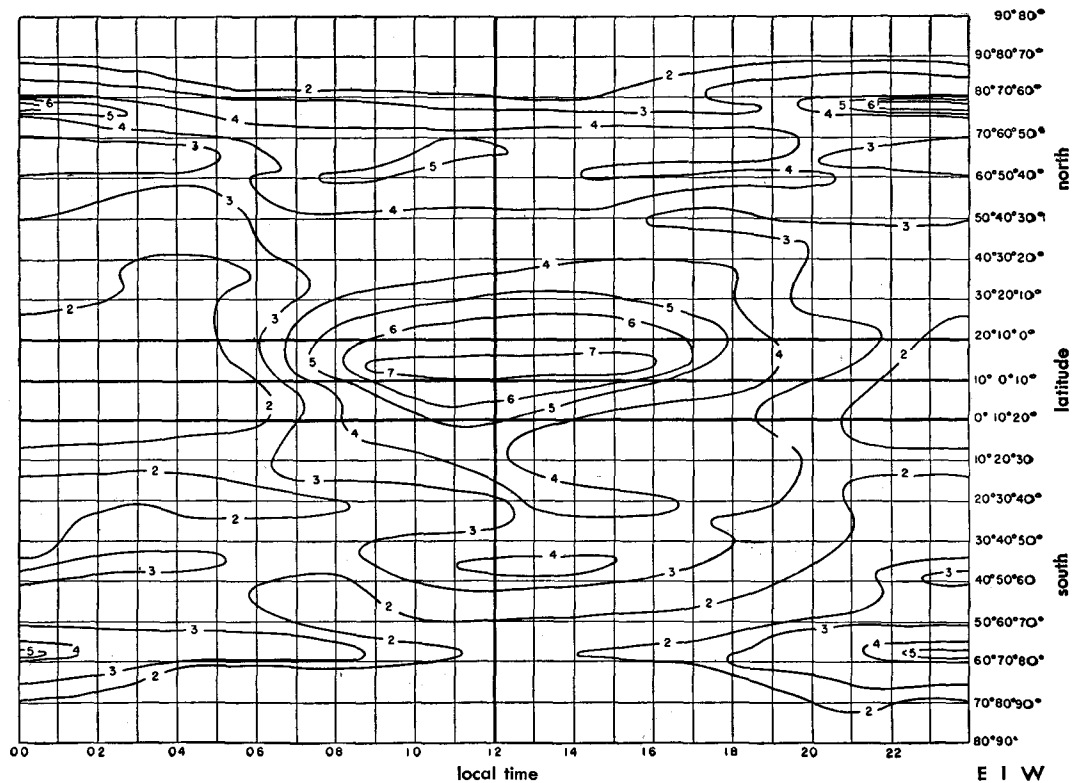

Fig. 12—Median fE_s in megacycles (sporadic E layer) predicted for July, 1946

Propagation of very short waves

For propagation over distance within the radio path horizon, the field intensity is given approximately by

$$E = \frac{14.0\sqrt{W}}{d} \sin\left(\frac{2\pi h_t h_r}{\lambda d}\right) \text{ volts per meter} \quad (1)$$

where

W = watts radiated, h_t = height of transmitting antenna in meters, h_r = height of receiving antenna in meters, λ = wavelength in meters, d = distance in meters.

The following approximate formula is useful for transmission below 100 megacycles within the radio path horizon.

$$E = \frac{0.33 \sqrt{P} H_t H_r f_{mc}}{D^2} \text{ microvolts per meter} \quad (2)$$

where

P = kilowatts radiated, H_t = height of transmitting antenna in feet, H_r = height of receiving antenna in feet, f_{mc} = frequency in megacycles, D = distance in statute miles.

Equations (1) and (2) apply to both vertical and horizontal polarization. It is assumed that the antennas are small dipoles. The equations hold only when the transmission distance is large compared to antenna heights, i.e.,

for equation (1) $d > 10 h_r$

for equation (2) $D > 4 H_t H_r f_{mc} \times 10^{-6}$

Multiplying the true radius of the earth by correction factor 1.33 to provide for average atmospheric refraction gives the radio path horizon as

$$D_l = \sqrt{2H_t} + \sqrt{2H_r} \text{ statute miles}$$

If the refractive effect of the atmosphere is ignored, *line-of-sight horizon* is reduced to the geometric range

$$D_g = 1.23 (\sqrt{H_t} + \sqrt{H_r})$$

These distances may be obtained from the nomograph, Fig. 13.

When the transmission distance is not large compared with antenna height, the field strength oscillates with distance and height as indicated by the sine term of equation (1).

The number of oscillations for a given distance increases with frequency as illustrated in Fig. 14. This is due to interference between the space wave and the ground-reflected wave as these two components fall in or out of phase at various distances and heights.

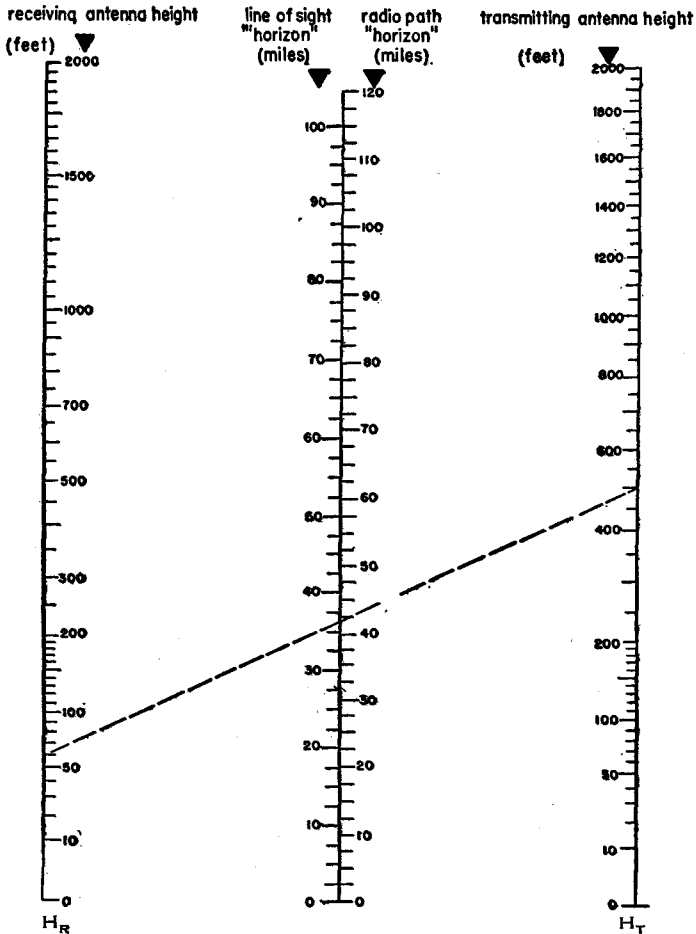
U-H-F path length and optical line-of-sight**distance range of radio waves**

The theoretical maximum path of a radio wave, the sum of the "optical" horizon distances of each antenna, is found on "line-of-sight" scale by a line connecting points representing the two antenna heights. Atmospheric diffraction increases this path an amount generally considered as $2/\sqrt{3}$ times optical line of sight, given on the radio path scale.

Example shown: Height of receiving antenna 60 feet, height of transmitting antenna 500 feet, and maximum radio path length 41.5 miles.

Fig. 13.

Propagation of very short waves *continued*

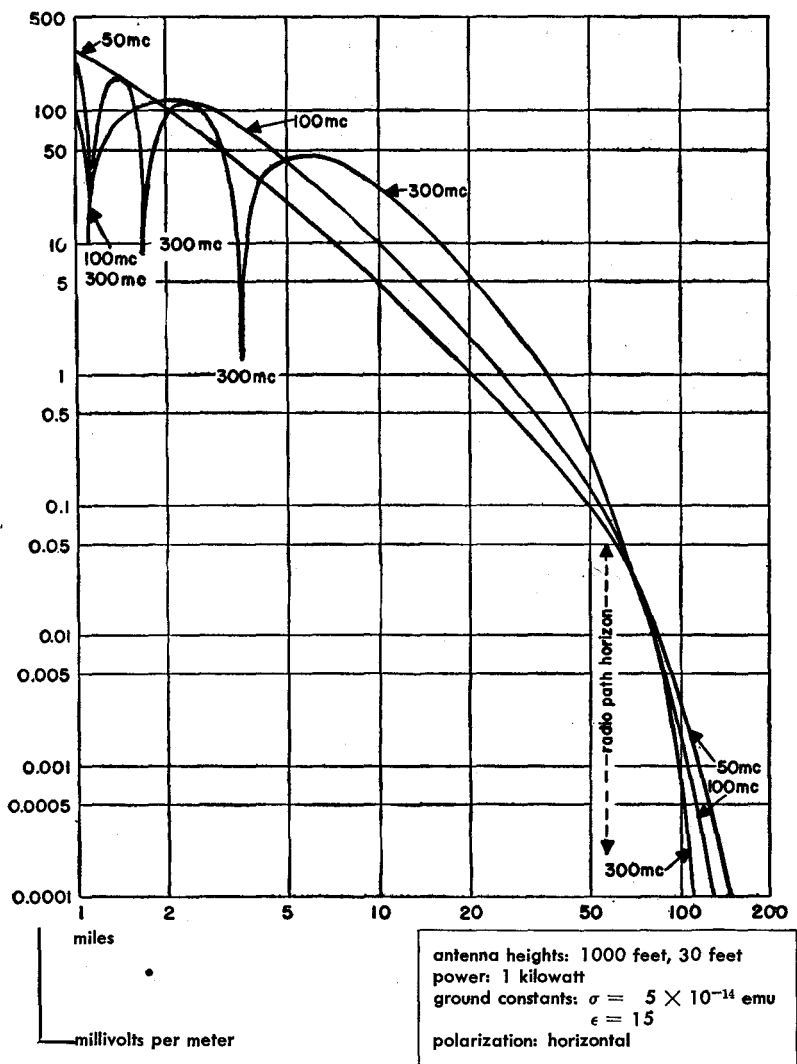

Fig. 14—Effect of frequency on ground-wave field intensity.

To compute the field accurately under these conditions, it is necessary to calculate the two components separately and to add them in correct phase relationship as determined by the geometry of the path and the change in magnitude and phase at ground reflection. For horizontally-polarized waves, the reflection coefficient can be taken as approximately one, and the phase

Propagation of very short waves *continued*

shift at reflection as 180 degrees, for nearly all types of ground and angles of incidence. For vertically-polarized waves, the reflection coefficient and phase shift vary with the ground constants and angle of incidence.*

For methods of computing field intensities when equations (1) and (2) do not hold beyond the radio path horizon, or when the antenna height is not negligible compared to distance, see reference below.†

At points beyond the radio path horizon, field intensity decreases more rapidly than the square of the distance; and, if the antennas are raised, the field intensity increases more rapidly than the product of antenna heights.

Measured field intensities usually show large deviations from point to point due to reflections from irregularities in the ground, buildings, trees, etc. In addition, fields at the longer distances are subject to fading and day-to-day variations due to changes in the refractive index of the atmosphere and tropospheric reflections.

* See Burrows, C. R., *Radio Propagation over Plane Earth-Field Strength Curves*. Bell System Tech. Jour., vol. 16 January 1937.

† See Norton, K. A., *The Effect of Frequency on the Signal Range of an Ultra-High Frequency Radio Station*. FCC Mimeo Report 48466 (March 20, 1941).

Great circle calculations

Referring to Figs. 15, 16, and 17, A and B are two places on the earth's surface the latitudes and longitudes of which are known. The angles X and Y at A and B of the great circle passing through the two places and the distance Z between A and B along the great circle can be calculated as follows:

B is the place of greater latitude, i.e., nearer the pole

L_A is the latitude of A

L_B is the latitude of B

C is the difference of longitude between A and B

$$\text{Then, } \tan \frac{Y - X}{2} = \cot \frac{C}{2} \frac{\sin \frac{L_B - L_A}{2}}{\cos \frac{L_B + L_A}{2}}$$

$$\text{and, } \tan \frac{Y + X}{2} = \cot \frac{C}{2} \frac{\cos \frac{L_B - L_A}{2}}{\sin \frac{L_B + L_A}{2}}$$

$$\text{give the values of } \frac{Y - X}{2} \text{ and } \frac{Y + X}{2}$$

Great circle calculations *continued*

from which

$$\frac{Y + X}{2} + \frac{Y - X}{2} = Y$$

and

$$\frac{Y + X}{2} - \frac{Y - X}{2} = X$$

In the above formulas, north latitudes are taken as positive and south latitudes as negative. For example, if B is latitude 60° N and A is latitude 20° S

$$\frac{L_B + L_A}{2} = \frac{60 + (-20)}{2} = \frac{60 - 20}{2} = \frac{40}{2} = 20^\circ$$

and

$$\frac{L_B - L_A}{2} = \frac{60 - (-20)}{2} = \frac{60 + 20}{2} = \frac{80}{2} = 40^\circ$$

If both places are in the southern hemisphere and $L_B + L_A$ is negative, it is simpler to call the place of greater south latitude B and to use the above method for calculating bearings from true south and to convert the results afterwards to bearings east of north.

The distance Z (in degrees) along the great circle between A and B is given by the following:

$$\tan \frac{Z}{2} = \tan \frac{L_B - L_A}{2} \frac{\sin \frac{Y + X}{2}}{\sin \frac{Y - X}{2}}$$

The angular distance Z (in degrees) between A and B may be converted to linear distance as follows:

$$\begin{aligned} Z \text{ (in degrees)} \times 111.195 &= \text{kilometers} \\ Z \text{ (in degrees)} \times 69.093 &= \text{statute miles} \\ Z \text{ (in degrees)} \times 60.000 &= \text{nautical miles} \end{aligned}$$

In multiplying, the minutes and seconds of arc must be expressed in decimals of a degree. For example, $Z = 37^\circ 45' 36''$ becomes 37.755°.

Example.—Find the great circle bearings at Brentwood, Long Island, Longitude $73^\circ 15' 10''$ W, Latitude $40^\circ 48' 40''$ N, and at Rio de Janeiro, Brazil, Longitude $43^\circ 22' 07''$ W, Latitude $22^\circ 57' 09''$ S, and the great circle distance in statute miles between the two points.

Great circle calculations *continued*

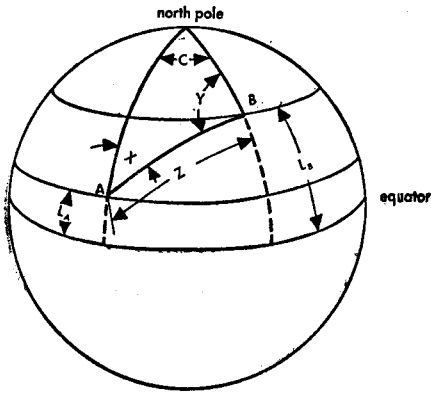

Fig. 15

L_A = latitude of A
 L_B = latitude of B
 C = difference of longitude

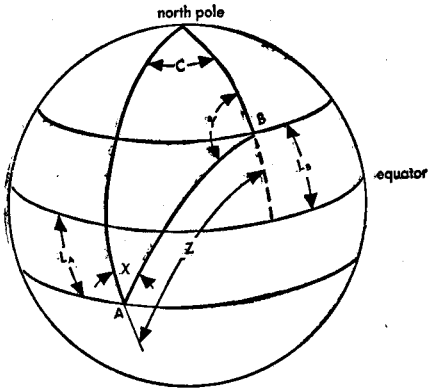

Fig. 16

L_A = latitude of A
 L_B = latitude of B
 C = difference of longitude

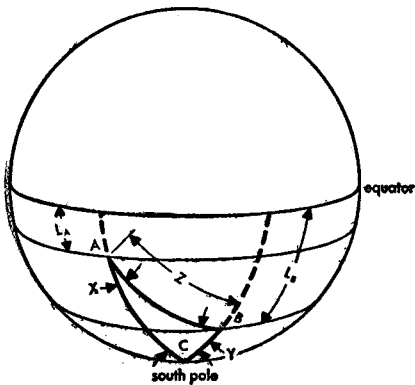

Fig. 17

L_A = latitude of A
 L_B = latitude of B
 C = difference of longitude

Great circle calculations *continued*

	longitude	latitude	
Brentwood	73° 15' 10'' W	40° 48' 40'' N	L_B
Rio de Janeiro	43° 22' 07'' W	(-)22° 57' 09'' S	L_A
C	29° 53' 03''	17° 51' 31'' 63° 45' 49''	$L_B + L_A$ $L_B - L_A$

$$\frac{C}{2} = 14^\circ 56' 31''$$

$$\frac{L_B + L_A}{2} = 8^\circ 55' 45''$$

$$\frac{L_B - L_A}{2} = 31^\circ 52' 54''$$

$$\log \cot 14^\circ 56' 31'' = 10.57371$$

$$\begin{aligned} \text{plus } \log \cos 31^\circ 52' 54'' &= 9.92898 \\ &\quad 0.50269 \end{aligned}$$

$$\text{minus } \log \sin 8^\circ 55' 45'' = 9.19093$$

$$\log \tan \frac{Y+X}{2} = 1.31176$$

$$\frac{Y+X}{2} = 87^\circ 12' 26''$$

$$\log \cot 14^\circ 56' 31'' = 10.57371$$

$$\begin{aligned} \text{plus } \log \sin 31^\circ 52' 54'' &= 9.72277 \\ &\quad 0.29648 \end{aligned}$$

$$\text{minus } \log \cos 8^\circ 55' 45'' = 9.99471$$

$$\log \tan \frac{Y-X}{2} = 0.30177$$

$$\frac{Y-X}{2} = 63^\circ 28' 26''$$

$$\frac{Y+X}{2} + \frac{Y-X}{2} = Y = 150^\circ 40' 52'' \text{ East of North—bearing at Brentwood}$$

$$\frac{Y+X}{2} - \frac{Y-X}{2} = X = 23^\circ 44' 00'' \text{ West of North—bearing at Rio de Janeiro}$$

$$\frac{L_B - L_A}{2} = 31^\circ 52' 54''$$

$$\frac{Y+X}{2} = 87^\circ 12' 26''$$

$$\frac{Y-X}{2} = 63^\circ 28' 26''$$

$$\log \tan 31^\circ 52' 54'' = 9.79379$$

$$\begin{aligned} \text{plus } \log \sin 87^\circ 12' 26'' &= 9.99948 \\ &\quad 9.79327 \end{aligned}$$

$$\text{minus } \log \sin 63^\circ 28' 26'' = 9.95170$$

$$\log \tan \frac{Z}{2} = 9.84157$$

$$\frac{Z}{2} = 34^\circ 46' 24''$$

$$Z = 69^\circ 32' 48''$$

$$69^\circ 32' 48'' = 69.547^\circ$$

$$\text{linear distance} \approx 69.547 \times 69.093 = 4805.21 \text{ statute miles}$$

Time interval between transmission and reception of reflected signal

Fig. 18 gives the time interval between transmission and reception of a reflected signal based on a velocity of propagation in free space of 985 feet per microsecond or 300 meters per microsecond. A statute mile of 5280 feet or 1760 yards or 1.609 kilometers is used.

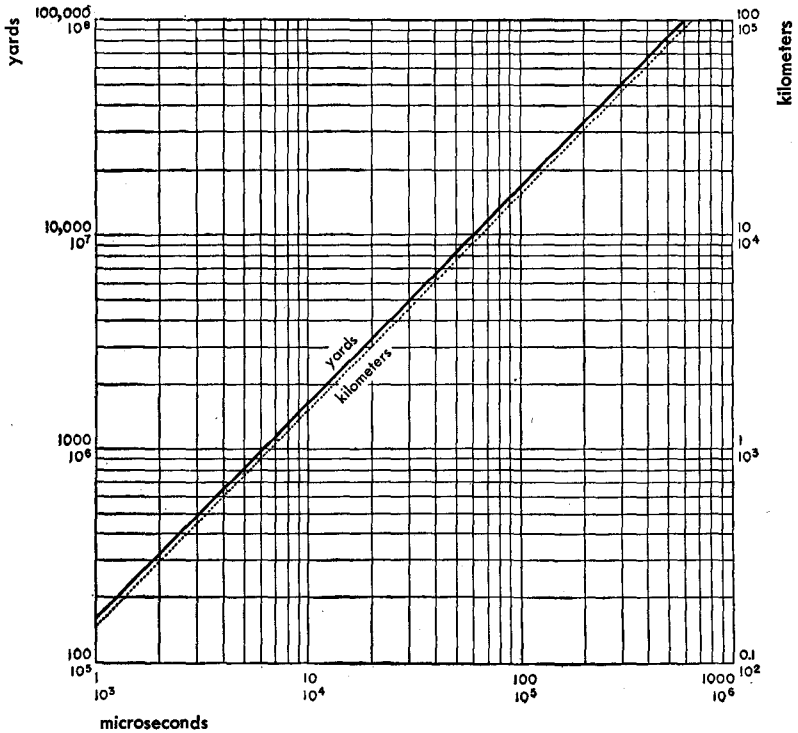

Note: Ordinates show distance to point of reflection

Fig. 18.

Radio noise and noise measurement*

Radio noise may be divided into four classifications, depending on origin:

1. Atmospheric noise (static)
2. Cosmic noise
3. Man-made noise
4. Receiver and antenna noise

* See also section on Wire Telephony—Noise and Noise Measurement.

Radio noise and noise measurement *continued*

Radio noise, as in Fig. 19, is usually expressed in terms of peak values. Atmospheric noise is shown in the figure as the average peaks would be read on the indicating instrument of an ordinary field intensity meter. This is lower than the true peaks of atmospheric noise. Man-made noise is shown as the peak values that would be read on the EEI-NEMA-RMA standard noise meter. Receiver and antenna noise is shown with the peak values 13 decibels higher than the values obtained with an energy averaging device such as a thermoammeter.

1. Atmospheric noise: is produced mostly by lightning discharges in thunderstorms. The noise level is thus dependent on frequency, time of day, weather, season of the year, and geographical location.

Subject to variations due to local stormy areas, noise generally decreases with increasing latitude on the surface of the globe. Noise is particularly severe during the rainy seasons in certain areas such as Caribbean, East Indies, equatorial Africa, northern India, etc. Fig. 19 shows median values of atmospheric noise for the U. S. A. and these values may be assumed to apply approximately to other regions lying between 30 and 50 degrees latitude north or south.

Rough approximations for atmospheric noise in other regions may be obtained by multiplying the values of Fig. 19 by the factors in Table III.

Table III—Multiplying factors for atmospheric noise in regions not shown on Fig. 19

latitude	nighttime		daytime	
	100 kc	10 mc	100 kc	10 mc
90°-50°	0.1	0.3	0.05	0.1
50°-30°	1	1	1	1
30°-10°	2	2	3	2
10°- 0°	5	4	6	3

Atmospheric noise is the principal limitation of radio service on the lower frequencies. At frequencies above about 30 megacycles, the noise falls to levels generally lower than receiver noise.

The peak amplitude of atmospheric noise usually may be assumed to be proportional to the square root of receiver bandwidth.

2. Cosmic noise: originates outside the earth's atmosphere and appears as a random noise like thermal agitation. Cosmic noise has been observed and measured at frequencies from 10 to 20 megacycles and at frequencies of about 160 megacycles. It is reasonable to assume that it exists at all frequencies between 10 and 1000 megacycles and higher.

Radio noise and noise measurement *continued*

The intensity of cosmic noise is generally lower than interference produced by other sources. In the absence of atmospheric and man-made noise, it may be the principal limiting factor in reception between 10 and 30 megacycles.

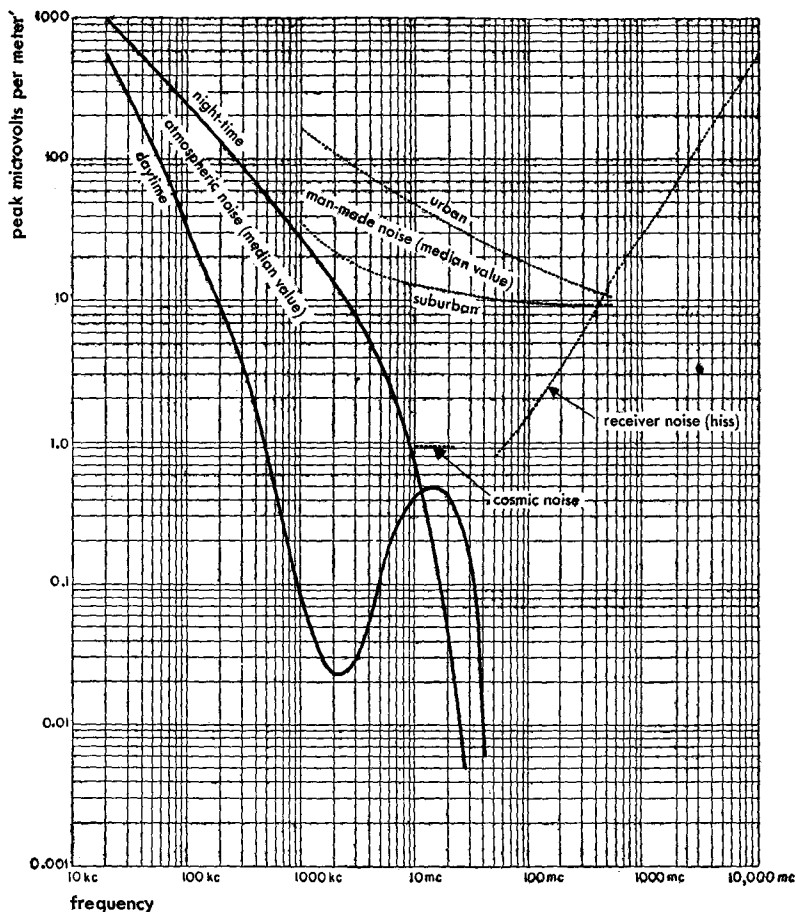
**Notes:**

1. All noise curves assume a bandwidth of 10 kilocycles.
2. Receiver noise is based on the use of a half-wave dipole antenna and is worse than an ideal receiver by 10 decibels at 50 megacycles and 15 decibels at 1000 megacycles.
3. Refer to Fig. 20 for converting man-made noise curves to bandwidths greater than 10 kilocycles.
4. For all other curves, noise varies as the square root of bandwidth.

Fig. 19.

Radio noise and noise measurement *continued*

3. Man-made noise: includes interference produced by sources such as motorcar ignition, electric motors, electric switching gear, high-tension line leakage, diathermy, industrial heating generators. The field intensity from these sources is greatest in densely populated and industrial areas.

The nature of man-made noise is so variable that it is difficult to formulate a simple rule for converting 10 kilocycle bandwidth receiver measurements to other bandwidth values. For instance, the amplitude of the field strength radiated by a diathermy device will be the same in a 100- as in a 10-kilocycle bandwidth receiver. Conversely, peak noise field strength due to automobile ignition will be considerably greater with a 100- than with a 10-kilocycle bandwidth. According to the best available information, the peak field strengths of man-made noise (except diathermy and other narrow-band noise) increases as the receiver bandwidth is increased, substantially as shown in Fig. 20.

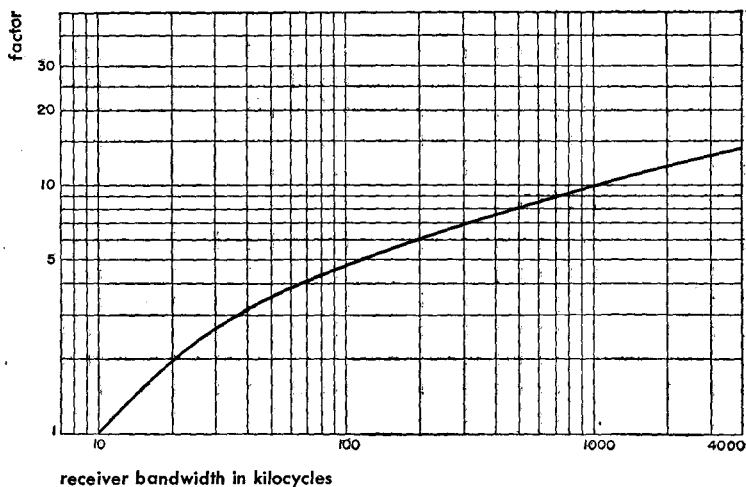

Fig. 20—Bandwidth factor. Multiply value of man-made noise from Fig. 19 by the factor above for receiver bandwidths higher than 10 kilocycles.

The man-made noise curves in Fig. 19 show typical median values for the U.S.A. In accordance with statistical practice, median values are interpreted to mean that 50 percent of all sites will have lower noise levels than the values of Fig. 19; 70 percent of all sites will have noise levels less than 1.9 times these values; and 90 percent of all sites, less than seven times these values.

Radio noise and noise measurement *continued*

4. Receiver and antenna noise: is caused by thermal agitation in resistance components of the antenna and receiver circuits and by electronic current flow in the tubes.

The basic equation for thermal agitation noise is

$$E^2 = 4 kTR \Delta f$$

where

E = rms volts

k = Boltzmann's constant = 1.374×10^{-23}

T = absolute temperature in degrees Kelvin

R = resistance in ohms

Δf = bandwidth in cycles per second

For application of this formula to receiver input circuits see Herold, E. W., *An Analysis of the Signal-to-Noise Ratio of Ultra-High-Frequency Receivers*; and North, D. O., *The Absolute Sensitivity of Radio Receivers*. RCA Review, vol. 6 (January, 1942).

The ideal receiver is one in which the only noise is that generated by thermal agitation in the radiation resistance of the antenna and in the input coupling resistance. The calculated values shown in Fig. 19 are based on the assumption that an actual receiver has a noise level greater than the ideal receiver by a factor varying from 10 decibels at 50 megacycles to 15 decibels at 1000 megacycles.

The peak value of this type of noise is approximately 13 decibels greater than its rms value. The amplitude is proportional to the square root of receiver bandwidth. Fig. 19 shows the field intensities required to equal the peak receiver noise values calculated on the above basis. These equivalent field intensities assume the use of a half-wave dipole receiving antenna. Transmission-line loss is omitted in the calculations. For antennas delivering more power to the receiver than a half-wave dipole, equivalent noise field intensities are less than indicated in Fig. 19 in proportion to the net gain of the antenna plus transmission line.

5. Signal-to-noise ratio: for satisfactory reception varies over wide limits dependent on the type of communication, bandwidth, type of modulation, directivity of receiving antenna, character of noise, etc. A rough general relationship applicable to many services is that the average value of field intensity should be at least 10 decibels higher than the peak noise intensity, both measured on nondirective antennas with the noise peaks as observed on the usual type of measuring devices. Due to the relationship between peak and average values for noise, this means that the average field intensity should exceed the average noise intensity by at least 20 to 25 decibels.

Radio noise and noise measurement *continued*

Considerably higher ratios of signal-to-noise fields are required for many uses such as AM program transmission, television, loop direction finding, etc.

6. Measurement of radio noise: External noise fields, such as atmospheric, cosmic, and man-made, are measured in the same way as radio wave field strengths* with the exception that peak rather than average values of noise are usually of interest and that the overall bandpass action of the measuring apparatus must be accurately known in measuring noise. When measuring noise varying over wide limits with time, such as atmospheric noise, it is generally best to employ automatic recorders.

Internal receiver and antenna noise may be measured by a standard signal generator connected to the receiver through a resistance equal to the calculated antenna radiation resistance. The amplitude of a single-frequency signal at the center of the pass band, when receiver output is $\sqrt{2}$ times the noise output with no signal, may be taken as equal to the noise amplitude.

* For methods of measuring field strengths and, hence, noise, see *I.R.E. Standards on Radio Wave Propagation. Measuring Methods* (1942). For information on suitable circuits to obtain peak values, particularly with respect to man-made noise, see Agger, C. V., Foster, D. E., and Young, C. S. *Instruments and Methods of Measuring Radio Noise*. Trans. A.I.E.E. (Elec. Eng., March, 1940), vol. 59.

Field intensity from an elementary dipole*

The elementary dipole forms the basis for many antenna computations. Since dipole theory assumes an antenna with current of constant magnitude and phase throughout its length, approximations to the elementary dipole are realized in practice only for antennas shorter than one-tenth wavelength. The theory can be applied directly to a loop whose circumference is less than one-tenth wavelength, thus forming a magnetic dipole. For larger antennas, the theory is applied by assuming the antenna to consist of a large number of infinitesimal dipoles with differences between individual dipoles of space position, polarization, current magnitude, and phase corresponding to the distribution of these parameters in the actual antenna. Field intensity equations for large antennas are then developed by integrating or otherwise summing the field vectors of the many elementary dipoles.

The outline below concerns electric dipoles. It also can be applied to magnetic dipoles by installing the loop perpendicular to the PO line at the center of the sphere in Fig. 1. In this case, vector h becomes ϵ , the electric field; ϵ_t becomes the magnetic tangential field; and ϵ_r the radial magnetic field.

Fig. 1
Electric and magnetic components in spherical coordinates for electric dipoles.

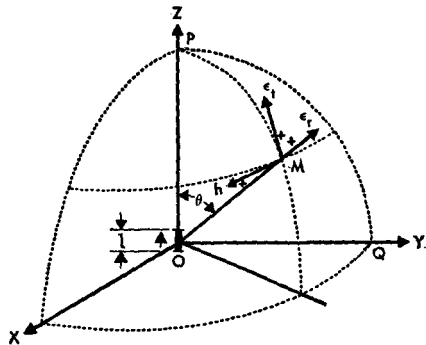

In the case of a magnetic dipole, Table I, showing variations of the field in the vicinity of the dipole, can also be used. A_r is then the coefficient for the radial magnetic field; A_t is the coefficient for the tangential magnetic field; A_h is the coefficient for the electric field; ϕ_r ; ϕ_t ; and ϕ_h being the phase angles corresponding to the coefficients.

* Based on Mesny, R., *Radio-Electricité Générale*.

Field intensity from an elementary dipole *continued*

For electric dipoles, Fig. 1 indicates the electric and magnetic field components in spherical coordinates with positive values shown by the arrows.

- r = distance OM
- θ = angle POM measured from P toward M
- I = current in dipole
- λ = wavelength
- f = frequency
- $\omega = 2\pi f$
- $\alpha = \frac{2\pi}{\lambda}$
- c = velocity of light (see page 28)
- $v = \omega t - \alpha r$
- l = length of dipole

The following equations expressed in electromagnetic units* (in vacuum) result:

$$\left. \begin{aligned} \epsilon_r &= -\frac{cIl}{\pi r^3} \cos \theta (\cos v - \alpha r \sin v) \\ \epsilon_\theta &= +\frac{cIl}{2\pi r^3} \frac{\sin \theta}{r} (\cos v - \alpha r \sin v - \alpha^2 r^2 \cos v) \\ h &= -Il \frac{\sin \theta}{r^2} (\sin v - \alpha r \cos v) \end{aligned} \right\} \quad (1)$$

* See pages 16 and 17.

Table I—Variations of the field in the vicinity of a dipole

r/λ	$1/\alpha r$	A_r	ϕ	A_t	ϕ_t	A_h	ϕ_h
0.01	15.9	4,028	3° 6	4,012	3° 6	263	93° 6
0.02	7.96	508	7° 2	500	7° 3	64.2	97° 2
0.04	3.98	65	14° 1	61	14° 0	16.4	104° 1
0.06	2.65	19.9	20° 7	17.5	23° 8	7.67	110° 7
0.08	1.99	8.86	26° 7	7.12	33° 9	4.45	116° 7
0.10	1.59	4.76	32° 1	3.52	45° 1	2.99	122° 1
0.15	1.06	1.66	42° 3	1.14	83° 1	1.56	132° 3
0.20	0.80	0.81	51° 5	0.70	114° 0	1.02	141° 5
0.25	0.64	0.47	57° 5	0.55	133° 1	0.75	147° 5
0.30	0.56	0.32	62° 0	0.48	143° 0	0.60	152° 0
0.35	0.45	0.23	65° 3	0.42	150° 1	0.50	155° 3
0.40	0.40	0.17	68° 3	0.37	154° 7	0.43	158° 3
0.45	0.35	0.134	70° 5	0.34	158° 0	0.38	160° 5
0.50	0.33	0.106	72° 3	0.30	160° 4	0.334	162° 3
0.60	0.265	0.073	75° 1	0.26	164° 1	0.275	165° 1
0.70	0.228	0.053	77° 1	0.22	166° 5	0.234	167° 1
0.80	0.199	0.041	78° 7	0.196	168° 3	0.203	168° 7
0.90	0.177	0.032	80° 0	0.175	169° 7	0.180	170° 0
1.00	0.159	0.026	80° 9	0.157	170° 7	0.161	170° 9
1.20	0.133	0.018	82° 4	0.132	172° 3	0.134	172° 4
1.40	0.114	0.013	83° 5	0.114	173° 5	0.114	173° 5
1.60	0.100	0.010	84° 3	0.100	174° 3	0.100	174° 3
1.80	0.088	0.008	84° 9	0.088	174° 9	0.088	174° 9
2.00	0.080	0.006	85° 4	0.080	175° 4	0.080	175° 4
2.50	0.064	0.004	86° 4	0.064	176° 4	0.064	176° 4
5.00	0.032	0.001	88° 2	0.032	178° 2	0.032	178° 2

Field intensity from an elementary dipole *continued*

These formulas are valid for the elementary dipole at distances which are large compared with the dimensions of the dipole. Length of the dipole must be small with respect to the wavelength, say $\frac{l}{\lambda} < 0.1$. The formulas are for a dipole in free space. If the dipole is placed vertically on a plane of infinite conductivity, its image should be taken into account, thus doubling the above values.

Field of an elementary dipole at great distance

When distance r exceeds five wavelengths, as is generally the case in radio applications, the product $\alpha r = 2\pi \frac{r}{\lambda}$ is large and lower powers in αr can be neglected. The radial electric field ϵ_r then becomes negligible with respect to the tangential field and

$$\left. \begin{aligned} \epsilon_r &= 0 \\ \epsilon_t &= -\frac{2\pi c I l}{\lambda r} \sin \theta \cos(\omega t - \alpha r) \\ h &= -\frac{\epsilon_t}{c} \end{aligned} \right\} \quad (2)$$

Field of an elementary dipole at short distance

In the vicinity of the dipole ($\frac{r}{\lambda} < 0.01$), αr is very small and only the first terms between parentheses in equations (1) remain. The ratio of the radial and tangential field is then,

$$\frac{\epsilon_r}{\epsilon_t} = -2 \cot \theta$$

Hence, the radial field at short distance has a magnitude of the same order as the tangential field. These two fields are in opposition. Further, the ratio of the magnetic and electric tangential field is

$$\frac{h}{\epsilon_t} = -\frac{\alpha r}{c} \frac{\sin \nu}{\cos \nu}$$

The magnitude of the magnetic field at short distances is, therefore, extremely small with respect to that of the tangential electric field, relative to their relationship at great distances. The two fields are in quadrature. Thus, at short distances, the effect of the dipole on an open circuit is much greater than on a closed circuit as compared with the effect at remote points.

Field of an elementary dipole at intermediate distance

At intermediate distance, say between 0.01 and 5.0 wavelengths, one should take into account all the terms of the equations (1). This case occurs, for instance, when studying reactions between adjacent antennas. To calculate the fields, it is convenient to transform the equations as follows:

$$\left. \begin{aligned} \epsilon_r &= -2\alpha^2 c I \cos \theta A_r \cos (v + \phi_r) \\ \epsilon_t &= \alpha^2 c I \sin \theta A_t \cos (v + \phi_t) \\ h &= \alpha^2 I \sin \theta A_h \cos (v + \phi_h) \end{aligned} \right\} \quad (3)$$

where

$$\left. \begin{aligned} A_r &= \frac{\sqrt{1 + (\alpha r)^2}}{(\alpha r)^3} & \tan \phi_r &= \alpha r \\ A_t &= \frac{\sqrt{1 - (\alpha r)^2 + (\alpha r)^4}}{(\alpha r)^3} & \cot \phi_r &= \frac{1}{\alpha r} - \alpha r \\ A_h &= \frac{\sqrt{1 + (\alpha r)^2}}{(\alpha r)^2} & \cot \phi_h &= -\alpha r \end{aligned} \right\} \quad (4)$$

Values of A 's and ϕ 's are given in Table I as a function of the ratio between the distance r and the wavelength λ . The second column contains values of $\frac{1}{\alpha r}$ which would apply if the fields ϵ_t and h behaved as at great distances.

Field intensity from a vertically polarized

antenna with base close to ground

The following formula is obtained from elementary dipole theory and is applicable to low frequency antennas. It assumes that the earth is a perfect reflector, the antenna dimensions are small compared with λ , and the actual

height does not exceed $\frac{\lambda}{4}$.

The vertical component of electric field radiated in the ground plane, at distances so short that ground attenuation may be neglected (usually when $D < 10 \lambda$), is given by

$$E = \frac{377 I H_e}{\lambda D}$$

where

E = field intensity in millivolts per meter

I = current at base of antenna in amperes

H_e = effective height of antenna

λ = wavelength in same units as H

D = distance in kilometers

Field intensity from a vertically polarized

antenna with base close to ground continued

The effective height of a grounded vertical antenna is equivalent to the height of a vertical wire producing the same field along the horizontal as the actual antenna, provided the vertical wire carries a current that is constant along its entire length and of the same value as at the base of the actual antenna. Effective height depends upon the geometry of the antenna and varies slowly with λ . For types of antennas normally used at low and medium frequencies, it is roughly one-half to two-thirds the actual height of the antenna.

For certain antenna configurations effective height can be calculated by the following formulas

1. Straight vertical antenna $\left(h \approx \frac{\lambda}{4} \right)$

$$H_e = \frac{\lambda}{\pi \sin \frac{2\pi h}{\lambda}} \sin^2 \left(\frac{\pi h}{\lambda} \right)$$

where h = actual height

2. Loop antenna ($A < 0.001 \lambda^2$)

$$H_e = \frac{2\pi nA}{\lambda}$$

where A = mean area per turn of loop

n = number of turns

3. Adcock antenna

$$H_e = \frac{2\pi ab}{\lambda}$$

where

a = height of antenna

b = spacing between antennas

In the above formulas, if H_e is desired in meters or feet, all dimensions h , A , a , b , and λ must be in meters or feet respectively.

Vertical radiators

The field intensity from a single vertical tower insulated from ground and either of self-supporting or guyed construction, such as is commonly used for medium-frequency broadcasting, may be calculated by the following

Vertical radiators *continued*

formula. This is more accurate than the formula given on page 253. Near ground level the formula is valid within the range $2\lambda < D < 10\lambda$.

$$E = \frac{60 I}{D \sin 2\pi \frac{h}{\lambda}} \left[\frac{\cos (2\pi \frac{h}{\lambda} \cos \theta) - \cos 2\pi \frac{h}{\lambda}}{\sin \theta} \right] \tag{5}$$

where

- E = field intensity in millivolts per meter
- I = current at base of antenna in amperes
- h = height of antenna
- λ = wavelengths in same units as h
- D = distance in kilometers
- θ = angle from the vertical

Radiation patterns in the vertical plane for antennas of various heights are shown in Fig. 2. Field intensity along the horizontal as a function of antenna height for one kilowatt radiated is shown in Fig. 3.

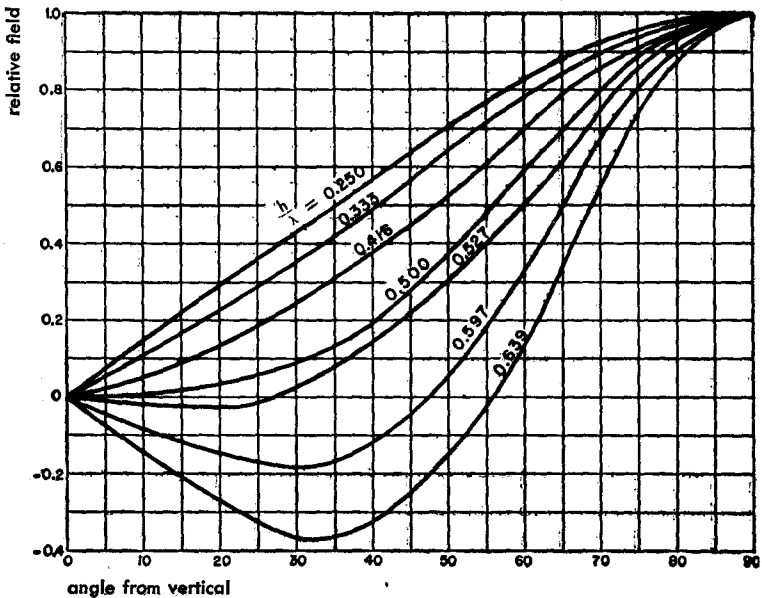

Fig. 2—Field strength as a function of angle of elevation for vertical radiators of different heights.

Vertical radiators *continued*

Both Figs. 2 and 3 assume sinusoidal distribution of current along the antenna and perfect ground conductivity. Current magnitudes for one-kilowatt power used in calculating Fig. 3 are also based on the assumption that the only resistance is the theoretical radiation resistance of a vertical wire with sinusoidal current.

Since inductance and capacitance are not uniformly distributed along the tower and since current is attenuated in traversing the tower, it is impossible to obtain sinusoidal current distribution in practice. Consequently actual radiation patterns and field intensities differ from Figs. 2 and 3.* The closest approximation to sinusoidal current is found on constant cross-section towers.

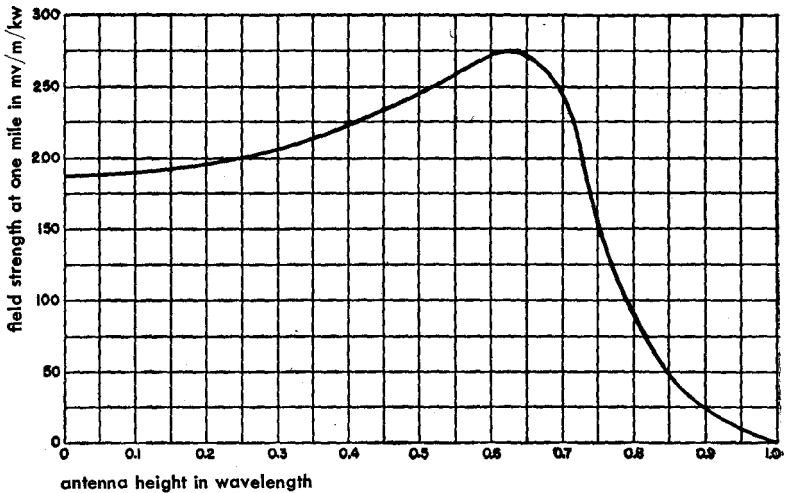

Fig. 3—Field strength along the horizontal as a function of antenna height for a vertical grounded radiator with one kilowatt radiated power.

In addition, antenna efficiencies vary from about 70 percent for 0.15 wavelength physical height to over 95 percent for 0.6 wavelength height. The input power must be multiplied by the efficiency to obtain the power radiated.

Average results of measurements of impedance at the base of several actual

* For information on the effect of some practical current distributions on field intensities see Gihring, H. E. and Brown, G. H. *General Considerations of Tower Antennas for Broadcast Use*. Proc. I.R.E., vol. 23, p. 311 (April, 1935).

Vertical radiators *continued*

vertical radiators, as given by Chamberlain and Lodge, are shown in Fig. 4. For design purposes when actual resistance and current of the projected radiator are unknown, resistance values may be selected from Fig. 4 and

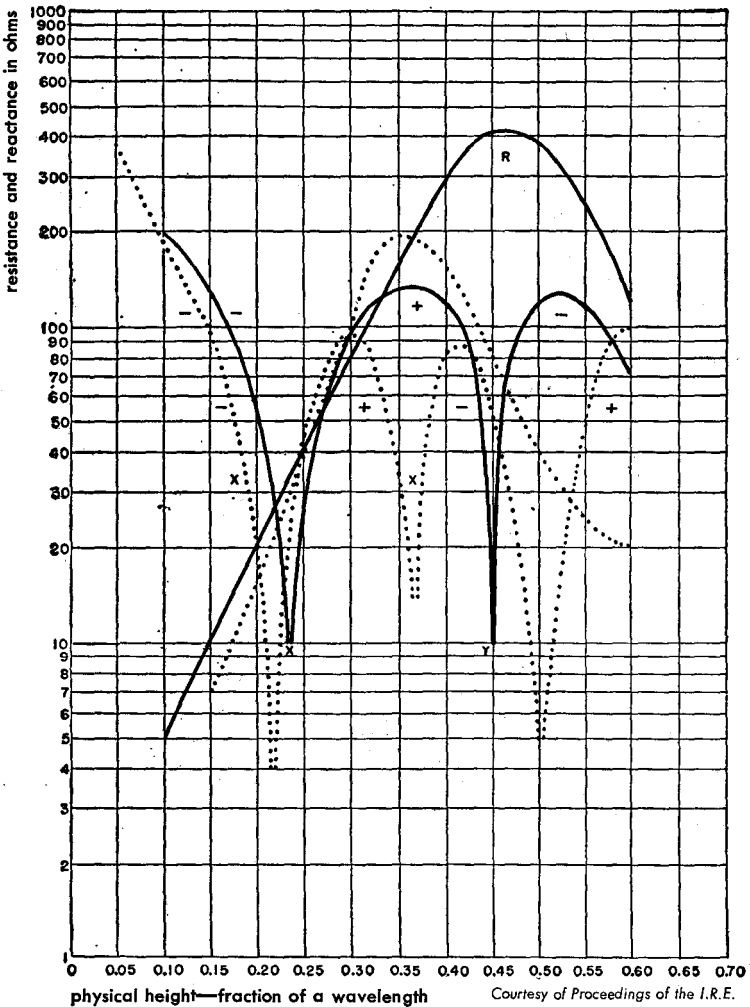

Fig. 4—Resistance and reactance components of impedance between tower base and ground of vertical radiators as given by Chamberlain and Lodge. Solid lines show average results for 5 guyed towers; dotted lines show average results for 3 self-supporting towers.

Vertical radiators *continued*

the resulting effective current obtained from the following equation

$$I_e = \sqrt{\frac{W\eta}{R}} \quad (6)$$

where

I_e = current effective in producing radiation in amperes

W = watts input

η = antenna efficiency, varying from 0.70 at $\frac{h}{\lambda} = 0.15$

to 0.95 at $\frac{h}{\lambda} = 0.6$

R = resistance at base of antenna in ohms

If I_e from (6) is substituted in (5), reasonable approximations to the field intensity at unit distances, such as one kilometer or one mile, will be obtained.

The practical equivalent of a higher tower may be secured by adding a capacitance "hat" with or without tuning inductance at the top of a lower tower.*

A good ground system is important with vertical-radiator antennas. It should consist of at least 120 radial wires, each one-half wavelength or longer, buried 6 to 12 inches below the surface of the soil. A ground screen of high-conductivity metal mesh, bonded to the ground system, should be used on or above the surface of the ground adjacent to the tower.

* For additional information see Brown, G. H., Proc. I.R.E., vol. 24, p. 48 (January, 1936) and Brown, G. H. and Leitch J. G., vol. 25, p. 533 (May, 1937).

Field intensity and radiated power from**a half-wave dipole in free space**

Fig. 5 on page 259 shows the field intensity and radiated power from a half-wave dipole in free space. The following formulas apply:

$$\text{Input power } W = I^2 R = I^2 (73.12) \text{ watts}$$

$$\text{Radiated power } P = \frac{30I^2}{\pi d^2} = \frac{0.1306W}{d^2} \text{ watts per square meter}$$

$$\text{Electric field intensity } E = \frac{60I}{d} = \frac{7.02\sqrt{W}}{d} \text{ volts per meter}$$

I = maximum current on dipole in rms amperes

R = radiation resistance = 73.12 ohms

d = distance from antenna in meters

Field intensity and radiated power from a half-wave dipole *continued*

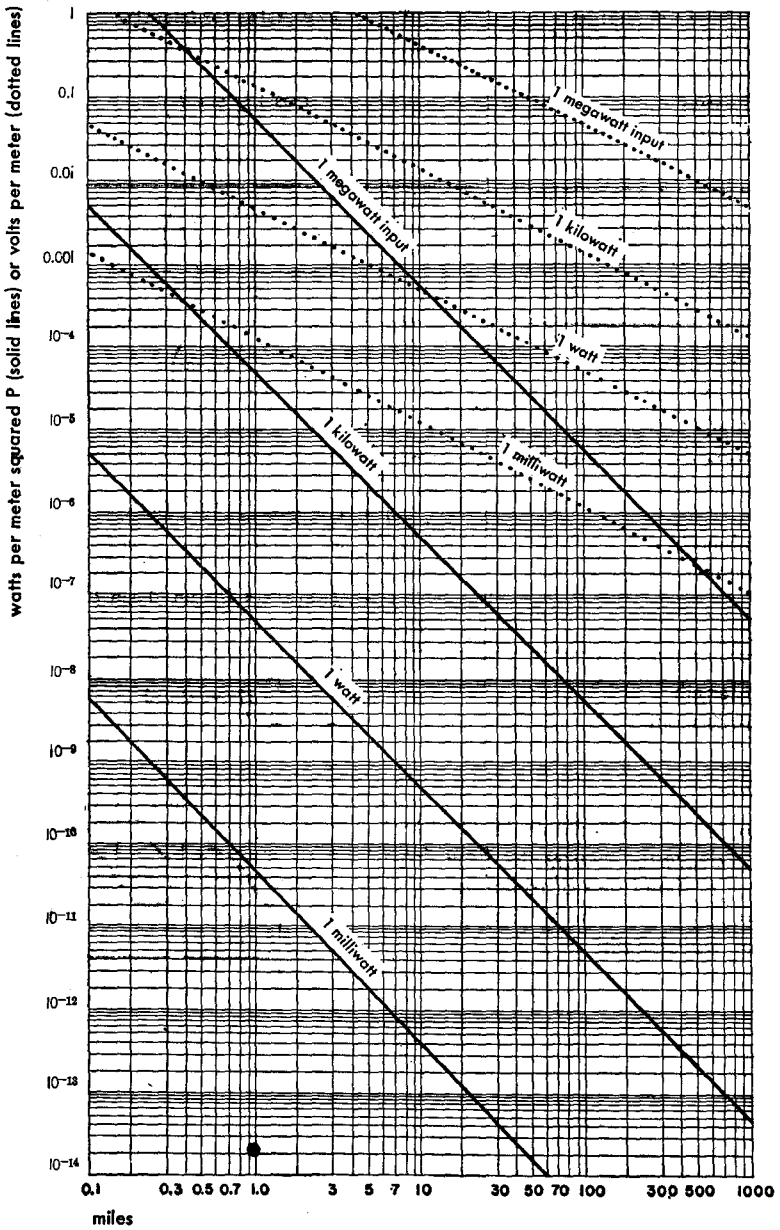

Fig. 5.

Table II—Radiation from an end-fed conductor of any length in space

configuration (length of radiator)	expression for intensity $F(\theta)$
Half wave resonant	$\frac{\cos\left(\frac{\pi}{2} \sin \theta\right)}{\cos \theta}$
Any odd number of half waves resonant	$\frac{\cos\left(\frac{l^\circ}{2} \sin \theta\right)}{\cos \theta}$
Any even number of half waves resonant	$\frac{\sin\left(\frac{l^\circ}{2} \sin \theta\right)}{\cos \theta}$
Any length resonant	$\frac{1}{\cos \theta} \left[1 + \cos^2 l^\circ + \sin^2 \theta \sin^2 l^\circ - 2 \cos(l^\circ \sin \theta) \cos l^\circ - 2 \sin \theta \sin(l^\circ \sin \theta) \sin l^\circ \right]^{\frac{1}{2}}$
Any length non-resonant	$\tan \frac{\theta}{2} \sin \frac{l^\circ}{2} (1 - \sin \theta)$

l° = length of radiator in electrical degrees, energy to flow from left-hand end of radiator.

θ = angle from the vertical

λ = wavelength

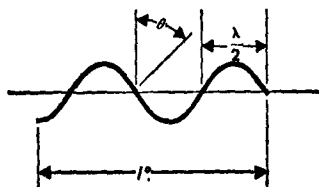

Maxima and minima of radiation from a single-wire radiator

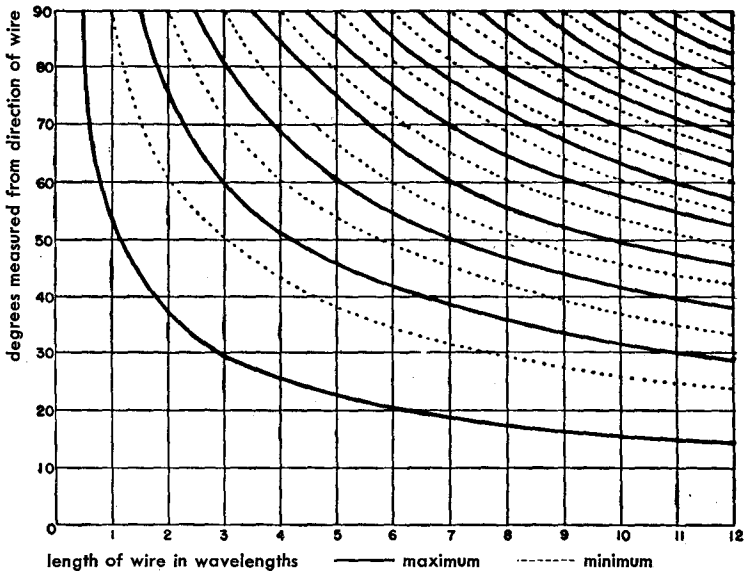

Fig. 6.

Rhombic antennas

Linear radiators may be combined in various ways to form antennas such as the horizontal vee, inverted vee, etc. The type most commonly used at high frequencies is the horizontal terminated rhombic shown in Fig. 7.

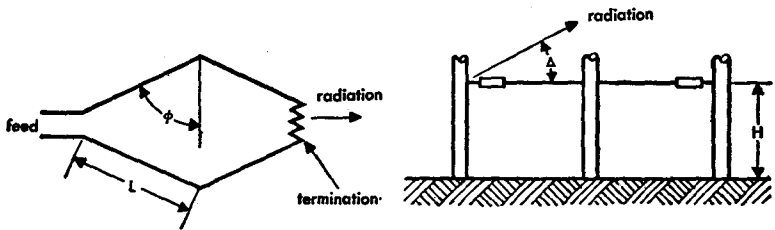

Fig. 7.

In designing rhombic antennas* for high-frequency radio circuits, the desired vertical angle Δ of radiation above the horizon must be known or assumed. When the antenna is to operate over a wide range of radiation angles or is to operate on several frequencies, compromise values of H , L , and ϕ must

* For more complete information see Harper, A. E. *Rhombic Antenna Design*. D. Van Nostrand Co. (1941).

Rhombic antennas *continued*

be selected. Gain of the antenna increases as the length of L of each side is increased; however, to avoid too-sharp directivity in the vertical plane, it is usual to limit L to less than six wavelengths.

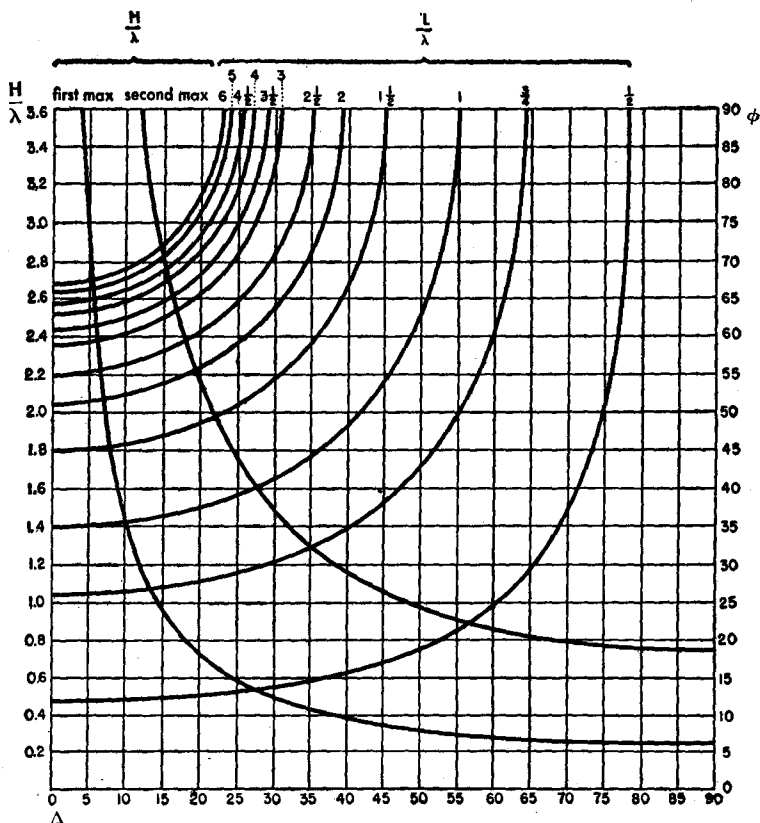

Fig. 8—Rhombic antenna design chart.

Knowing the side length and radiation angle desired, the height H above ground and the tilt angle ϕ can be obtained from Fig. 8 as in the following example:

Problem: Find H and ϕ if $\Delta = 20^\circ$ and $L = 4\lambda$.

Solution: On Fig. 8 draw a vertical line from $\Delta = 20^\circ$ to meet $\frac{L}{\lambda} = 4$ curve and $\frac{H}{\lambda}$ curves. From intersection at $\frac{L}{\lambda} = 4$, read $\frac{H}{\lambda}$ on the right-hand

Rhombic antennas *continued*

scale $\phi = 71.5^\circ$. From intersection on $\frac{H}{\lambda}$ curves, there are two possible values on the left-hand scale

$$1. \frac{H}{\lambda} = 0.74 \quad \text{or} \quad H = 0.74\lambda$$

$$2. \frac{H}{\lambda} = 2.19 \quad \text{or} \quad H = 2.19\lambda$$

Similarly, with an antenna 4λ on the side and a tilt angle $\phi = 71.5^\circ$, working backwards, it is found that the angle of maximum radiation Δ is 20° , if the antenna is 0.74λ or 2.19λ above ground.

Antenna arrays

The basis for all directivity control in antenna arrays is wave interference. By providing a large number of sources of radiation, it is possible with a fixed amount of power greatly to reinforce radiation in a desired direction by suppressing the radiation in undesired directions. The individual sources may be any type of antenna.

Expressions for the radiation pattern of several common types of individual elements are shown in Table III but the array expressions are not limited to them. The expressions hold for linear radiators, rhombics, vees, horn radiators, or other complex antennas when combined into arrays, provided a suitable expression is used for A , the radiation pattern of the individual antenna. The array expressions are multiplying factors. Starting with an individual antenna having a radiation pattern given by A , the result of combining it with similar antennas is obtained by multiplying A by a suitable array factor, thus obtaining an A' for the group. The group may then be treated as a single source of radiation. The result of combining the group with similar groups or, for instance, of placing the group above ground, is obtained by multiplying A' by another of the array factors given.





The expressions given here assume negligible mutual coupling between individual antennas. When coupling is not negligible, the expressions apply only if the feeding is adjusted to overcome the coupling and thus produce resultant currents which are equal or binomial in amplitude and of the relative phases indicated.

One of the most important arrays is the linear multi-element array where a large number of equally spaced antenna elements are fed equal currents in phase to obtain maximum directivity in the forward direction. Table IV gives expressions for the radiation pattern of several particular cases and the general case of any number of broadside elements.

Antenna arrays *continued*

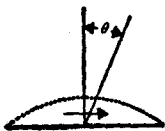
In this type of array, a great deal of directivity may be obtained. A large number of minor lobes, however, are apt to be present and they may be undesirable under some conditions, in which case a type of array, called the Binomial array, may be used. Here again all the radiators are fed in phase

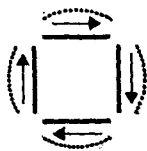
Table III—Radiation patterns of several common types of antennas

type of radiator	current distribution	directivity	
		horizontal $F(\theta)$	vertical $F(\beta)$
Half-wave dipole		$F(\theta) = K \frac{\cos\left(\frac{\pi}{2} \sin \theta\right)}{\cos \theta}$ $\cong K \cos \theta$	$F(\beta) = K(1)$
Shortened dipole		$F(\theta) \cong K \cos \theta$	$F(\beta) = K(1)$
Lengthened dipole		$F(\theta) = K \left[\frac{\cos\left(\frac{\pi l}{\lambda} \sin \theta\right) - \cos \frac{\pi l}{\lambda}}{\cos \theta} \right]$	$F(\beta) = K(1)$
Horizontal loop		$F(\theta) \cong K(1)$	$F(\beta) = K \cos \beta$
Horizontal turnstile	 i_1 and i_2 phased 90°	$F(\theta) \cong K'(1)$	$F(\beta) \cong K'(1)$

θ = horizontal angle measured from perpendicular bisecting plane

β = vertical angle measured from horizon

K and K' are constants and $K' \cong 0.7K$

Antenna arrays *continued*

but the current is not distributed equally among the array elements, the center radiators in the array being fed more current than the outer ones. Table V shows the configuration and general expression for such an array. In this case the configuration is made for a vertical stack of loop antennas

Table IV—Linear multi-element array broadside directivity

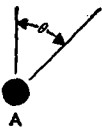
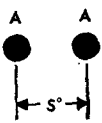
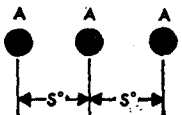
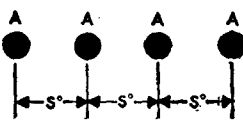
configuration of array	expression for intensity $F(\theta)$
	$A[1]$
	$2A \left[\cos \left(\frac{s^\circ}{2} \sin \theta \right) \right]$
	$A + 2A \left[\cos (s^\circ \sin \theta) \right]$
	$4A \left[\cos (s^\circ \sin \theta) \cos \left(\frac{s^\circ}{2} \sin \theta \right) \right]$
<p style="text-align: center;">m radiators (general case)</p>	$A \frac{\sin \left(m \frac{s^\circ}{2} \sin \theta \right)}{\sin \left(\frac{s^\circ}{2} \sin \theta \right)}$

$A = 1$ for horizontal loop, vertical dipole

$$A = \frac{\cos \left(\frac{\pi}{2} \sin \theta \right)}{\cos \theta} \text{ for horizontal dipole}$$

$s^\circ =$ spacing of successive elements in degrees

Antenna arrays *continued*

in order to obtain single-lobe directivity in the vertical plane. If such an array were desired in the horizontal plane, say n dipoles end to end, with the specified current distribution the expression would be

$$F(\theta) = 2^{n-1} \left[\frac{\cos\left(\frac{\pi}{2} \sin \theta\right)}{\cos \theta} \right] \cos^{n-1} \left(\frac{1}{2} S^\circ \sin \theta\right)$$

The term binomial results from the fact that the current intensity in the successive array elements is in accordance with the binomial expansion $(1 + 1)^{n-1}$, where n is the number of elements.

Examples of use of Tables III, IV, V, and VI

Problem 1: Find horizontal radiation pattern of four colinear horizontal dipoles, spaced successively $\frac{\lambda}{2}$ (180°).

Solution: From Table IV radiation from four radiators spaced 180° is given by

$$F(\theta) = 4A \cos(180^\circ \sin \theta) \cos(90^\circ \sin \theta).$$

From Table III the horizontal radiation of a half-wave dipole is given by

$$A = K \frac{\cos\left(\frac{\pi}{2} \sin \theta\right)}{\cos \theta};$$

therefore, the total radiation

$$F(\theta) = K \left[\frac{\cos\left(\frac{\pi}{2} \sin \theta\right)}{\cos \theta} \right] \cos(180^\circ \sin \theta) \cos(90^\circ \sin \theta)$$

Problem 2: Find vertical radiation pattern of four horizontal dipoles, stacked one above the other, spaced 180° successively.

Solution: From Table IV we obtain the general equation of four radiators, but since the spacing is vertical, the expression should be in terms of vertical angle β .

$$F(\beta) = 4A \cos(180^\circ \sin \beta) \cos(90^\circ \sin \beta).$$

From Table III we find that the vertical radiation from a horizontal dipole (in the perpendicular bisecting plane) is non-directional. Therefore the vertical pattern is

$$F(\beta) = K(1) \cos(180^\circ \sin \beta) \cos(90^\circ \sin \beta)$$

Antenna arrays continued

Table V—Development of binomial array

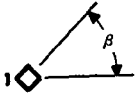
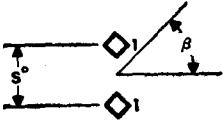
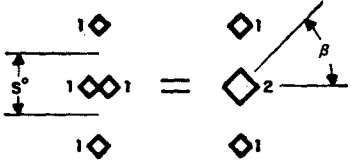
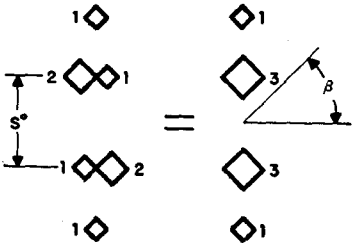
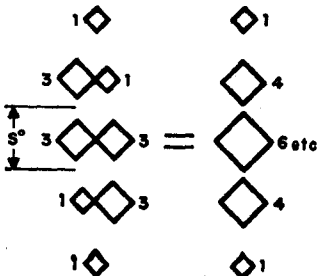
configuration of array	expression for intensity $F(\beta)$
	$\cos \beta [1]$
	$2 \cos \beta \left[\cos \left(\frac{s^\circ}{2} \sin \beta \right) \right]$
	$2^2 \cos \beta \left[\cos^2 \left(\frac{s^\circ}{2} \sin \beta \right) \right]$
	$2^3 \cos \beta \left[\cos^3 \left(\frac{s^\circ}{2} \sin \beta \right) \right]$
	$2^4 \cos \beta \left[\cos^4 \left(\frac{s^\circ}{2} \sin \beta \right) \right]$ and in general: $2^{n-1} \cos \beta \left[\cos^{n-1} \left(\frac{s^\circ}{2} \sin \beta \right) \right]$ where n is the number of loops in the array

Antenna arrays *continued*

Problem 3: Find horizontal radiation pattern of group of dipoles in problem 2.

Solution: From Table III.

$$F(\theta) = K \frac{\cos\left(\frac{\pi}{2} \sin \theta\right)}{\cos \theta} \cong K \cos \theta$$

Problem 4: Find the vertical radiation pattern of stack of five loops spaced $2/3 \lambda$ (120°) one above the other, all currents equal in phase and amplitude.

Solution: From Table IV, using vertical angle because of vertical stacking,

$$F(\beta) = A \frac{\sin [5(120^\circ) \sin \beta]}{\sin (120^\circ \sin \beta)}$$

From Table III, we find A for a horizontal loop in the vertical plane

$$A = F(\beta) = K \cos \beta$$

Total radiation pattern

$$F(\beta) = K \cos \beta \frac{\sin [5(120^\circ) \sin \beta]}{\sin (120^\circ \sin \beta)}$$

Problem 5: Find radiation pattern (vertical directivity) of the five loops in problem 4, if they are used in binomial array. Find also current intensities in the various loops.

Solution: From Table V

$$F(\beta) = K \cos \beta [\cos^4(120^\circ \sin \beta)]$$

(all terms not functions of vertical angle β combined in constant K)

Current distribution $(1 + 1)^4 = 1 + 4 + 6 + 4 + 1$, which represent the current intensities of successive loops in the array.

Problem 6: Find horizontal radiation pattern from two vertical dipoles spaced one-quarter wavelength apart when their currents differ in phase by 90° .

Solution: From Table VI

$$s^\circ = \frac{\lambda}{4} = 90^\circ = \text{spacing}$$

$$\phi = 90^\circ = \text{phase difference}$$

$$F(\theta) = 2A \cos (45 \sin \theta + 45^\circ)$$

Antenna arrays *continued*

Table VI—Supplementary problems

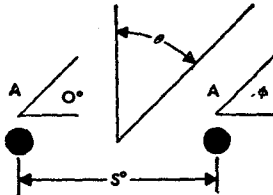
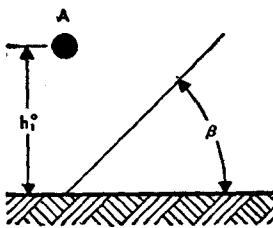
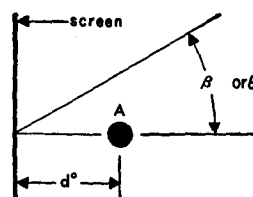
configuration of array	expression for intensity
<p>A—two radiators any phase ϕ</p> 	$F(\theta) = 2A \cos\left(\frac{s^\circ}{2} \sin \theta + \frac{\phi}{2}\right)$
<p>B—radiator above ground (horizontal polarization)</p> 	$F(\beta) = 2A \sin(h_1^\circ \sin \beta)$
<p>C—radiator parallel to screen</p> 	$F(\beta) = 2A \sin(d^\circ \cos \beta)$ <p>or</p> $F(\theta) = 2A \sin(d^\circ \cos \theta)$

s° = spacing in electrical degrees

h_1° = height of radiator in electrical degrees

d° = spacing of radiator from screen in electrical degrees

Antenna arrays *continued*

Problem 7: Find the vertical radiation pattern and the number of nulls in the vertical pattern ($0 \leq \beta \leq 90$) from a horizontal loop placed three wavelengths above ground.

Solution:

$$h_1^\circ = 3(360) = 1080^\circ$$

From Table VI

$$F(\beta) = 2A \sin(1080 \sin \beta)$$

From Table III for loop antennas

$$A = K \cos \beta$$

Total vertical radiation pattern

$$F(\beta) = K \cos \beta \sin(1080 \sin \beta)$$

A null occurs wherever $F(\beta) = 0$.

The first term, $\cos \beta$, becomes 0 when $\beta = 90^\circ$.

The second term, $\sin(1080 \sin \beta)$, becomes 0 whenever the value inside the parenthesis becomes a multiple of 180° . Therefore, number of nulls equal

$$1 + \frac{h_1^\circ}{180} = 1 + \frac{1080}{180} = 7.$$

Problem 8: Find the vertical and horizontal patterns from a horizontal half-wave dipole spaced $\frac{\lambda}{8}$ in front of a vertical screen.

Solution:

$$d^\circ = \frac{\lambda}{8} = 45^\circ$$

From Table VI

$$F(\beta) = 2A \sin(45^\circ \cos \beta)$$

$$F(\theta) = 2A \sin(45^\circ \cos \theta)$$

From Table III for horizontal half-wave dipole

Vertical pattern $A = K(1)$

$$\text{Horizontal pattern } A = K \frac{\cos\left(\frac{\pi}{2} \sin \theta\right)}{\cos \theta}$$

Total radiation patterns are

$$\text{Vertical: } F(\beta) = K \sin(45^\circ \cos \beta)$$

$$\text{Horizontal: } F(\theta) = K \frac{\cos\left(\frac{\pi}{2} \sin \theta\right)}{\cos \theta} \sin(45^\circ \cos \theta).$$

Antenna arrays continued

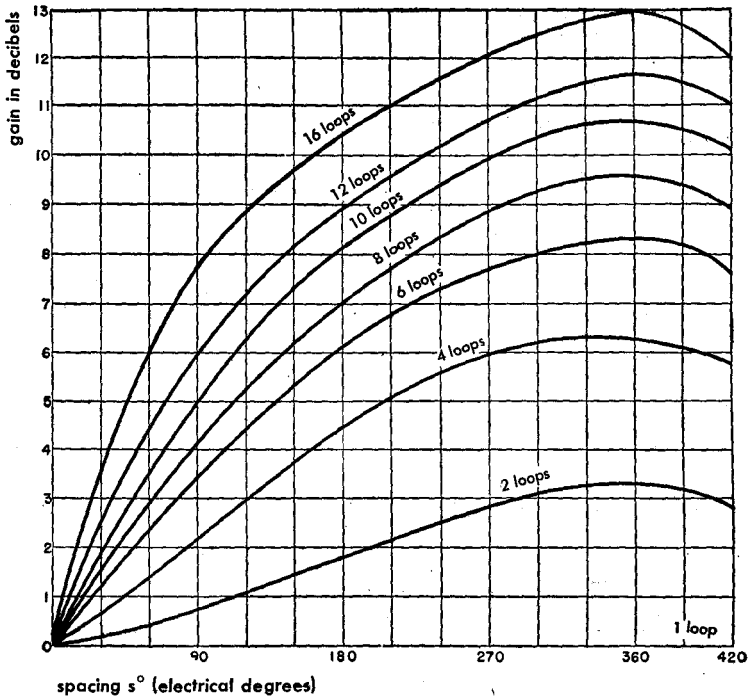

$$F(\beta) = \frac{\sin\left(\frac{ns^\circ}{2} \sin \beta\right)}{\sin\left(\frac{s^\circ}{2} \sin \beta\right)} \cos \beta$$

n = number of loops

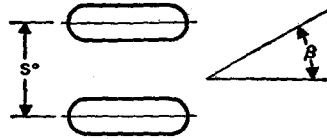

$$\text{Gain (db)} = 10 \log_{10} \left[\frac{1}{\frac{1}{n} + \frac{3}{n^2} \sum_{k=1}^{n-1} (n-k) \left[-\frac{2 \cos ks^\circ}{(ks^\circ)^2} + \frac{2 \sin ks^\circ}{(ks^\circ)^3} \right]} \right]$$

Fig. 9—Gain of linear array of loops vertically stacked.

■ Non-sinusoidal and modulated wave forms

Relaxation oscillators

Gas tube oscillator

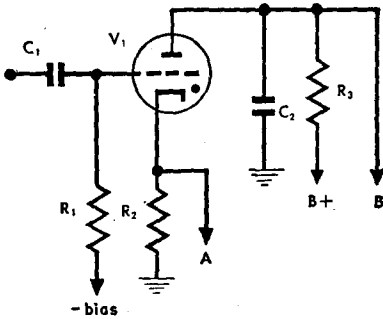

A = pulse output
B = sawtooth output

Typical circuit

$V_1 = 884$
 $C_1 = 0.05 \mu f$
 $C_2 = 0.05 \mu f$
 $R_1 = 100,000 \text{ ohms}$
 $R_2 = 500 \text{ ohms}$
 $R_3 = 100,000 \text{ ohms}$

Frequency controlling elements
 C_2, R_3

Feedback relaxation oscillator

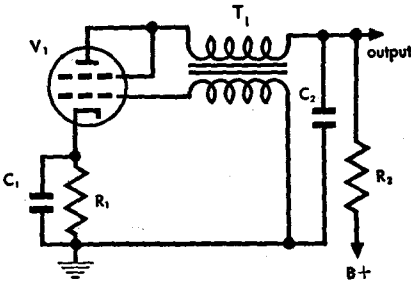

Typical circuit

$V_1 = 6F6$
 $T_1 = 3:1 \text{ audio transformer}$
 0.3 henry primary
 $R_1 = 100,000 \text{ ohms}$
 $R_2 = 5000 \text{ ohms}$
 $C_1 = 1 \mu f$
 $C_2 = 0.1 \mu f$

Frequency controlling elements
 C_2, R_2

Blocking oscillator

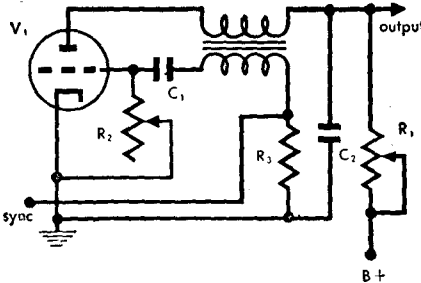

Typical circuit

$V_1 = 6J5$
 $C_1 = 0.01 \mu f$
 $C_2 = 0.25 \mu f$
 $R_1 = 1 \text{ megohm}$
 $R_2 = 1 \text{ megohm}$
 $R_3 = 1000 \text{ ohms}$

Frequency controlling elements
 R_1, C_2, R_3

Relaxation oscillators *continued*

Squegging oscillator

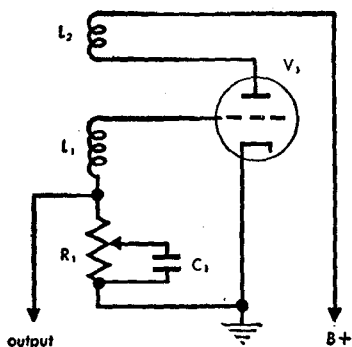

Typical circuit

- $V_1 = 6J5$
- L_1 } tightly coupled
- L_2 }
- $R_1 = 500,000$ ohms
- $C_1 = 0.01$ μf

Frequency controlling elements
 R_1, C_1

Multivibrator

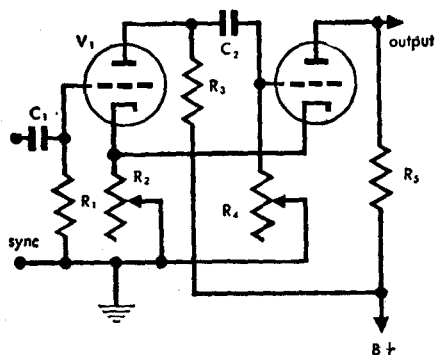

Typical circuit

- $V_1 = 6F8$
- $R_1 = 100,000$ ohms
- $R_2 = 1000$ ohms
- $R_3 = 25,000$ ohms
- $R_4 = 250,000$ ohms
- $R_5 = 25,000$ ohms
- $C_1 = 0.01$ μf
- $C_2 = 250$ $\mu\mu f$

Frequency controlling elements
 R_1, R_2, R_4, C_2

van der Pol oscillator

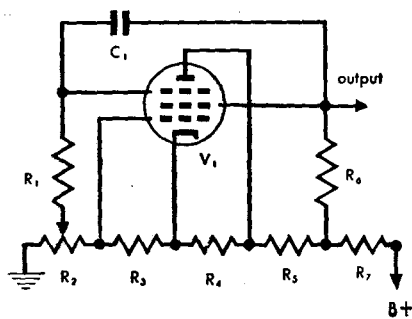

Typical circuit

- $V_1 = 6SJ7$
- $R_1 = 100,000$ ohms
- $R_2 = 500$ ohms
- $R_3 = 100$ ohms
- $R_4 = 3,000$ ohms
- $R_5 = 10,000$ ohms
- $R_6 = 25,000$ ohms
- $R_7 = 25,000$ ohms

Frequency controlling elements
 R_1, R_6, C_1 , (also B+)

Electronic integration methods

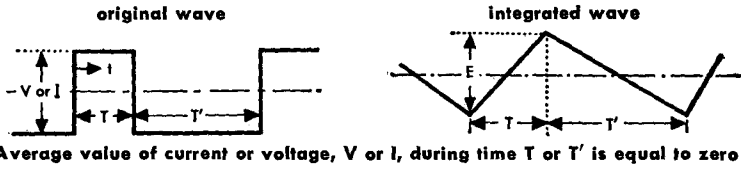

type	basic method	design formula	typical circuit
I Self-inductance	<p>constant voltage source</p>	$E = \frac{R}{L} VT$	<p>B+</p>
II Mutual inductance	<p>constant voltage source</p>	$E = \frac{R}{M} VT$	<p>B+</p>
III RC method	<p>constant voltage source</p>	$E = \frac{VT}{RC}$	<p>B+</p>

Electronic integration methods *continued*

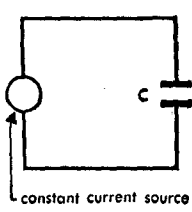
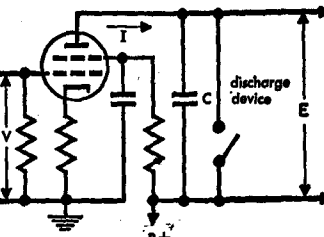
type	basic method	design formula	typical circuit
<p>IV Capacitance</p>		$E = \frac{IT}{C}$	

Methods I and II

- a. Voltage V must be obtained from a low-impedance source.
- b. $\frac{L}{R} \gg T$ or $\frac{M}{R} \gg T$
- c. The output E should not react back on the input voltage V .
- d. The impedance into which the integrator circuit works should be large compared with R . If this impedance is resistive, it should be included as part of R (this also applies to the input source impedance).

Method III

- a. Voltage V must be obtained from a low-impedance source.
- b. $RC \gg T$
- c. The output E should not react back on the input voltage V .
- d. The impedance into which the integrator circuit works should be as large as possible. If this impedance is resistive r then

$$rC \gg RC$$

The source impedance should be included in R .

Method IV

- a. Current I should be a replica of the input voltage wave-form V .
- b. The discharge device allows for integration between limits. If discharge device is not used, the circuit will integrate until E equals the $B+$ voltage.
- c. The impedance into which the integrator circuit works should be as large as possible. If this impedance is resistive r then $rC \gg T$.

Electronic differentiation methods

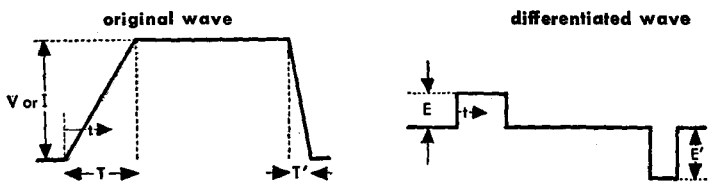

T or V is the change of current or voltage in time T

type	basic method	design formula	typical circuit
I Self-inductance	<p>constant current source</p>	$E = \frac{LI}{T}$	<p>B+</p>
II Mutual inductance	<p>constant current source</p>	$E = \frac{MI}{T}$	<p>B+</p>
III RC method		$E = \frac{VRC}{T} \left(1 - e^{-\frac{t}{RC}} \right)$	<p>B+</p>

Electronic differentiation methods *continued*

Methods I and II

- a. Current I should be a replica of the input voltage wave-form V .
- b. The voltage V must be substantially independent of the back emf developed by the inductance L .
- c. The output shunt impedance placed across E should be high compared to the network impedance.
- d. The resonant period associated with the inductance caused by shunting circuit capacitances should be at least one-third the build-up time T .

Method III

- a. Voltage V must be obtained from a low-impedance source.
- b. The RC product should be one-fiftieth of the build-up time T or smaller.
- c. The output voltage E should not react back on the input voltage V .
- d. The impedance into which the differentiator circuit works should be large compared with R . If this impedance is resistive, it should be included as part of R . (This also applies to the input source impedance.)

Fourier analysis of recurrent wave forms

General formulas

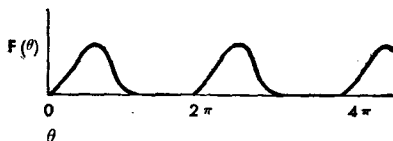

$$F(\theta) = \frac{B_0}{2} + A_1 \sin \theta + A_2 \sin 2\theta + \dots + A_n \sin n\theta + B_1 \cos \theta + B_2 \cos 2\theta + \dots + B_n \cos n\theta \tag{1}$$

Formula (1) may be written

$$F(\theta) = \frac{B_0}{2} + C_1 \cos (\theta - \phi_1) + C_2 \cos (2\theta - \phi_2) + \dots + C_n \cos (n\theta - \phi_n) \tag{2}$$

where

$$C_n = \sqrt{A_n^2 + B_n^2} \tag{3}$$

$$\phi_n = \arctan \frac{A_n}{B_n} \tag{4}$$

Fourier analysis of recurrent wave forms *continued*

The coefficients A_n and B_n are determined by the following formulas:

$$A_n = \frac{1}{\pi} \int_{-\pi}^{\pi} F(\theta) \sin n \theta \, d\theta \quad (5)$$

$$B_n = \frac{1}{\pi} \int_{-\pi}^{\pi} F(\theta) \cos n \theta \, d\theta \quad (6)$$

By a change of limits equations (5) and (6) may also be written

$$A_n = \frac{1}{\pi} \int_0^{2\pi} F(\theta) \sin n \theta \, d\theta \quad (7)$$

$$B_n = \frac{1}{\pi} \int_0^{2\pi} F(\theta) \cos n \theta \, d\theta \quad (8)$$

If the function $F(\theta)$ is an odd function, that is

$$F(\theta) = -F(-\theta) \quad (9)$$

the coefficients of all the cosine terms (B_n) of equation (6) become equal to zero.

Similarly if the function $F(\theta)$ is an even function, that is

$$F(\theta) = F(-\theta) \quad (10)$$

the coefficients of all the sine terms (A_n) of equation (5) become equal to zero.

If the function to be analyzed is thus a symmetrical function defined by either equation (9) or (10) the function should be disposed about the zero axis and an analysis obtained by means of equations (5) or (6) for the simplest solution.

Fourier analysis of recurrent wave forms *continued*

Graphical solution

If the function to be analyzed is not known analytically, a solution of the Fourier integral may be approximated by graphical means.

The period of the function is divided into a number of ordinates as indicated by the graph.

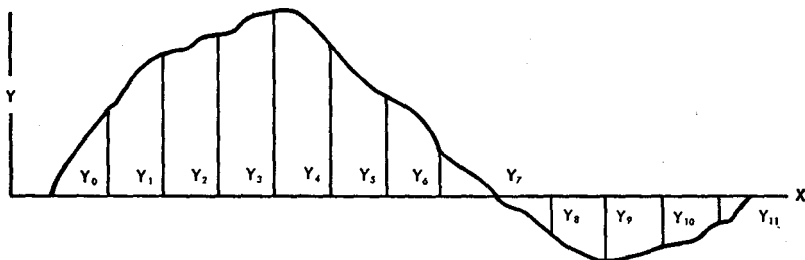

The values of these ordinates are recorded and the following computations made:

	Y_0	Y_1	Y_2	Y_3	Y_4	Y_5	Y_6		(11)
		Y_{11}	Y_{10}	Y_9	Y_8	Y_7			
Sum	S_0	S_1	S_2	S_3	S_4	S_5	S_6		
Difference		d_1	d_2	d_3	d_4	d_5			

The sum terms are arranged as follows:

	S_0	S_1	S_2	S_3		(12)	$\overline{S_0}$	$\overline{S_1}$		(13)
		S_6	S_5	S_4			$\overline{S_2}$	$\overline{S_3}$		
Sum	$\overline{S_0}$	$\overline{S_1}$	$\overline{S_2}$	$\overline{S_3}$			$\overline{S_7}$	$\overline{S_8}$		
Difference	$\overline{D_0}$	$\overline{D_1}$	$\overline{D_2}$							

The difference terms are as follows:

	d_1	d_2	d_3		(14)		(15)
	d_5	d_4				$\overline{S_4}$	$\overline{D_0}$
Sum	$\overline{S_4}$	$\overline{S_5}$	$\overline{S_6}$			$\overline{S_6}$	$\overline{D_2}$
Difference	$\overline{D_3}$	$\overline{D_4}$				$\overline{D_5}$	$\overline{D_6}$

Fourier analysis of recurrent wave forms *continued*

The coefficients of the Fourier series are now obtained as follows, where A_0 equals the average value, the $B_1 \dots n$ expressions represent the coefficients of the cosine terms, and the $A_1 \dots n$ expressions represent the coefficients of the sine terms:

$$B_0 = \frac{\overline{S_7} + \overline{S_8}}{12} \quad (16)$$

$$B_1 = \frac{\overline{D_0} + 0.866 \overline{D_1} + 0.5 \overline{D_2}}{6} \quad (17)$$

$$B_2 = \frac{\overline{S_0} + 0.5 \overline{S_1} - 0.5 \overline{S_2} - \overline{S_3}}{6} \quad (18)$$

$$B_3 = \frac{\overline{D_6}}{6} \quad (19)$$

$$B_4 = \frac{\overline{S_0} - 0.5 \overline{S_1} - 0.5 \overline{S_2} + \overline{S_3}}{6} \quad (20)$$

$$B_5 = \frac{\overline{D_0} - 0.866 \overline{D_1} + 0.5 \overline{D_2}}{6} \quad (21)$$

$$B_6 = \frac{\overline{S_7} - \overline{S_8}}{12} \quad (22)$$

also

$$A_1 = \frac{0.5 \overline{S_4} + 0.866 \overline{S_5} + \overline{S_6}}{6} \quad (23)$$

$$A_2 = \frac{0.866 (\overline{D_3} + \overline{D_4})}{6} \quad (24)$$

$$A_3 = \frac{\overline{D_5}}{6} \quad (25)$$

$$A_4 = \frac{0.866 (\overline{D_3} - \overline{D_4})}{6} \quad (26)$$

$$A_5 = \frac{0.5 \overline{S_4} - 0.866 \overline{S_5} + \overline{S_6}}{6} \quad (27)$$

Analyses of commonly encountered wave forms

The following analyses include the coefficients of the Fourier series for all harmonics (n^{th} order). By the use of the graph for the $\left(\frac{\sin x}{x}\right)$ function, where $f(x)$ is even, the amplitude coefficients may be evaluated in a simple manner.

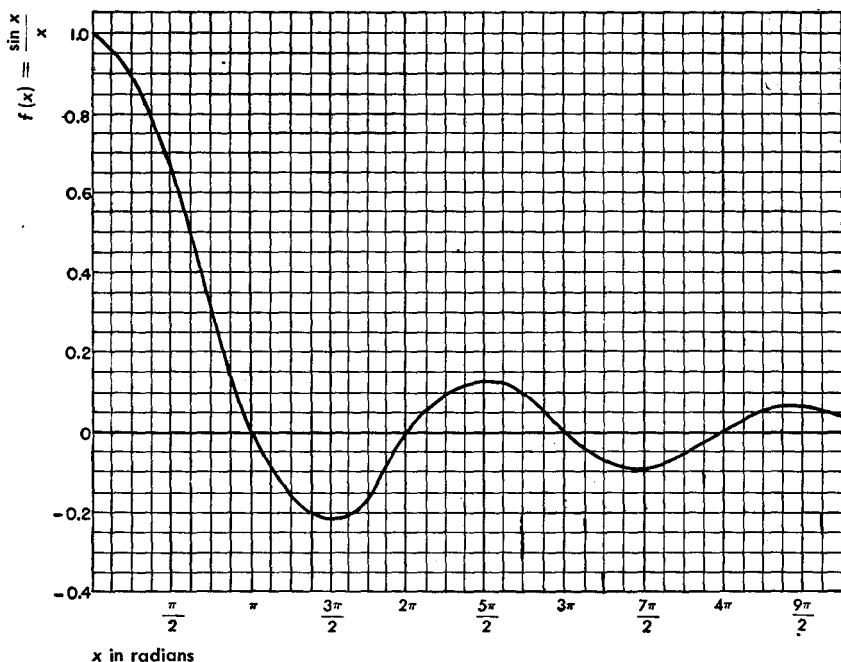

The symbols used are defined as follows:

A = pulse amplitude

r = pulse decay time

T = periodicity

n = order of harmonic

d = pulse width

C_n = amplitude of n^{th} harmonic

f = pulse build-up time

θ_n = phase angle of n^{th} harmonic

$$A_{av} = \text{average value of function} = \frac{1}{T} \int_0^T F(t) dt$$

$$A_{rms} = \text{root-mean square value of function} = \sqrt{\frac{1}{T} \int_0^T [F(t)]^2 dt}$$

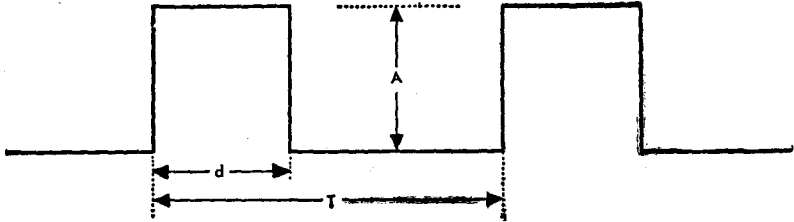
1. Rectangular wave

$$A_{av} = \frac{Ad}{T}$$

$$A_{rms} = A \sqrt{\frac{d}{T}}$$

$$C_n = 2 A_{av} \left[\frac{\sin \frac{n \pi d}{T}}{\frac{n \pi d}{T}} \right]$$

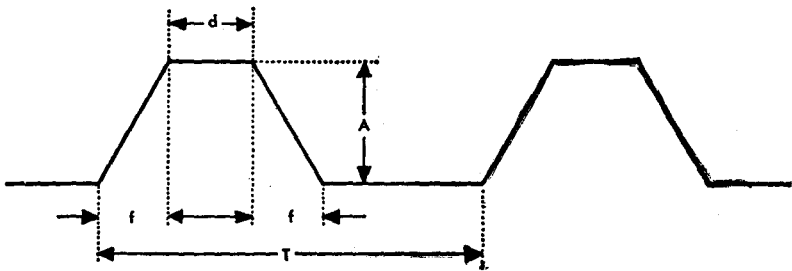
2. Symmetrical trapezoid wave

$$A_{av} = A \frac{(f + d)}{T}$$

$$A_{rms} = A \sqrt{\frac{2f + 3d}{3T}}$$

$$C_n = 2 A_{av} \left[\frac{\sin \frac{n \pi f}{T}}{\frac{n \pi f}{T}} \right] \left[\frac{\sin \frac{n \pi (f + d)}{T}}{\frac{n \pi (f + d)}{T}} \right]$$

Analyses of commonly encountered wave forms *continued*

3. Unsymmetrical trapezoid wave

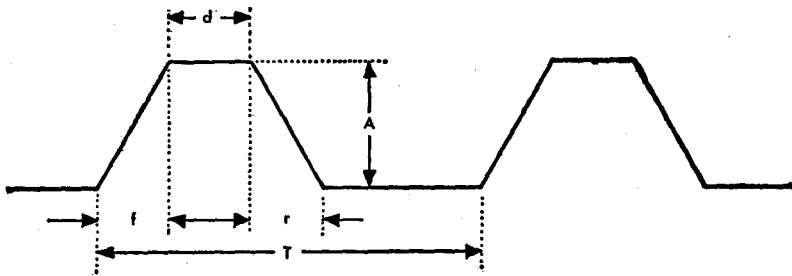

$$A_{av} = \frac{A}{T} \left[\frac{f}{2} + \frac{r}{2} + d \right]$$

$$A_{rms} = A \sqrt{\frac{f+r+3d}{3T}}$$

If $f \cong r$

$$C_n = 2 A_{av} \left[\frac{\sin \frac{n \pi f}{T}}{\frac{n \pi f}{T}} \right] \left[\frac{\sin \frac{n \pi (f+d)}{T}}{\frac{n \pi (f+d)}{T}} \right] \left[\frac{\sin \frac{n \pi (r-f)}{T}}{\frac{n \pi (r-f)}{T}} \right]$$

4. Isosceles triangle wave

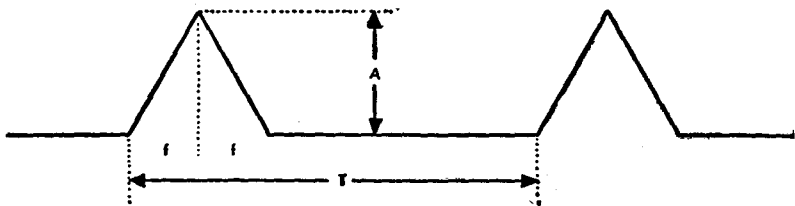

$$A_{av} = \frac{Af}{T}$$

$$A_{rms} = A \sqrt{\frac{2f}{3T}}$$

$$C_n = 2 A_{av} \left[\frac{\sin \frac{n \pi f}{T}}{\frac{n \pi f}{T}} \right]^2$$

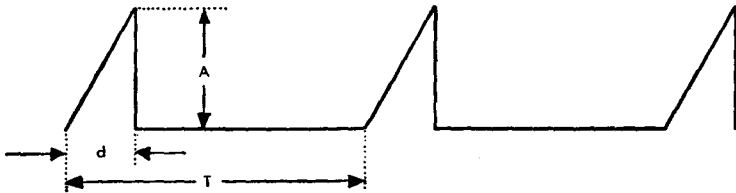
5. Clipped sawtooth wave

$$A_{av} = \frac{Ad}{2T}$$

$$A_{rms} = A \sqrt{\frac{d}{3T}}$$

$$C_n = \frac{AT}{2\pi^2 n^2 d} \left[2 \left(1 - \cos \frac{2\pi nd}{T} \right) + \frac{4\pi nd}{T} \left(\frac{\pi nd}{T} - \sin \frac{2\pi nd}{T} \right) \right]^{\frac{1}{2}}$$

If d is small

$$C_n = \frac{2A_{av}}{\frac{\pi nd}{T}} \left[\frac{\sin \frac{\pi nd}{T}}{\frac{\pi nd}{T}} - 1 \right]$$

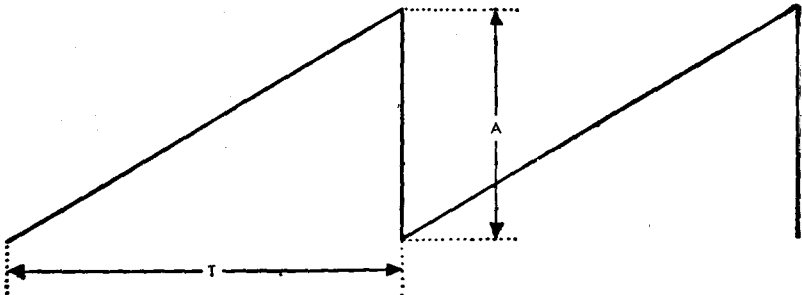
6. Sawtooth wave

$$A_{av} = \frac{A}{2}$$

$$A_{rms} = \frac{A}{\sqrt{3}}$$

$$C_n = -\frac{2A_{av}}{n\pi} \cos(n\pi)$$

Analyses of commonly encountered wave forms *continued*

7. Sawtooth wave

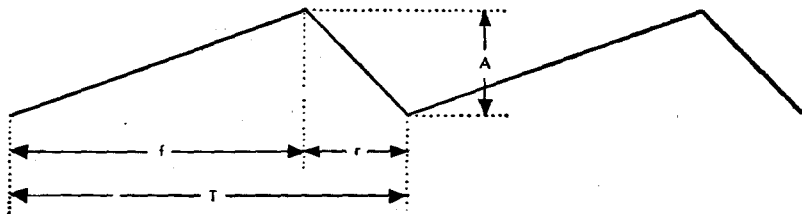

$$A_{av} = \frac{A}{2}$$

$$A_{rms} = \frac{A}{\sqrt{3}}$$

$$C_n = \frac{2 A_{av} T}{\pi^2 n^2 f \left(1 - \frac{f}{T}\right)} \sin \frac{\pi f}{T}$$

8. Fractional sine-wave

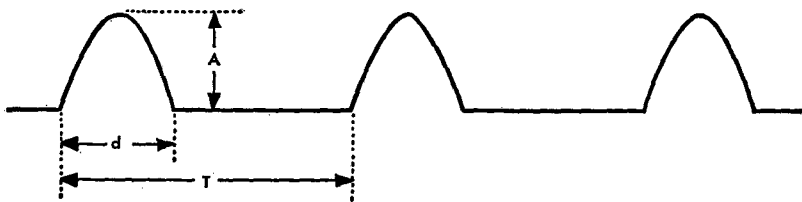

$$A_{av} = \frac{A \left(\sin \frac{\pi d}{T} - \frac{\pi d}{T} \cos \frac{\pi d}{T} \right)}{\pi \left(1 - \cos \frac{\pi d}{T} \right)}$$

$$A_{rms} =$$

$$\frac{A}{\left(1 - \cos \frac{\pi d}{T} \right)} \left[\frac{1}{2\pi} \left(\frac{\pi d}{T} + \frac{1}{2} \sin \frac{2\pi d}{T} - 4 \cos \frac{\pi d}{T} \sin \frac{\pi d}{T} + \frac{2\pi d}{T} \cos^2 \frac{\pi d}{T} \right) \right]^{\frac{1}{2}}$$

$$C_n = \frac{A_{av} \frac{\pi d}{T}}{n \left(\sin \frac{\pi d}{T} - \frac{\pi d}{T} \cos \frac{\pi d}{T} \right)} \left[\frac{\sin (n-1) \frac{\pi d}{T}}{(n-1) \frac{\pi d}{T}} - \frac{\sin (n+1) \frac{\pi d}{T}}{(n+1) \frac{\pi d}{T}} \right]$$

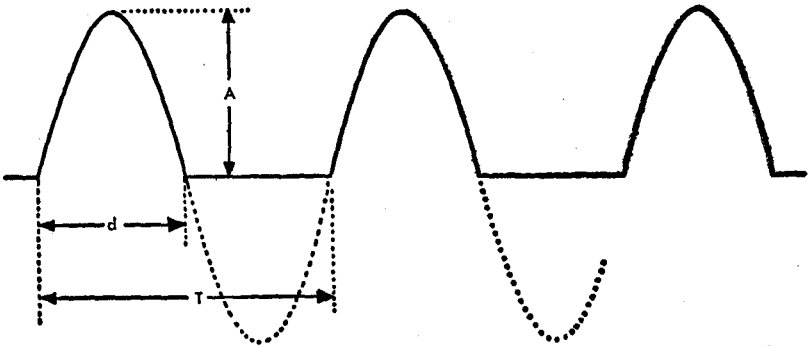
Analyses of commonly encountered wave forms *continued***9. Half sine-wave**

$$A_{av} = \frac{2A}{\pi} \frac{d}{T}$$

$$A_{rms} = A \sqrt{\frac{d}{2T}}$$

$$C_n = \frac{\pi}{2} A_{av} \left[\frac{\sin \frac{\pi}{2} \left(1 - \frac{2nd}{T}\right)}{\frac{\pi}{2} \left(1 - \frac{2nd}{T}\right)} + \frac{\sin \frac{\pi}{2} \left(1 + \frac{2nd}{T}\right)}{\frac{\pi}{2} \left(1 + \frac{2nd}{T}\right)} \right]$$

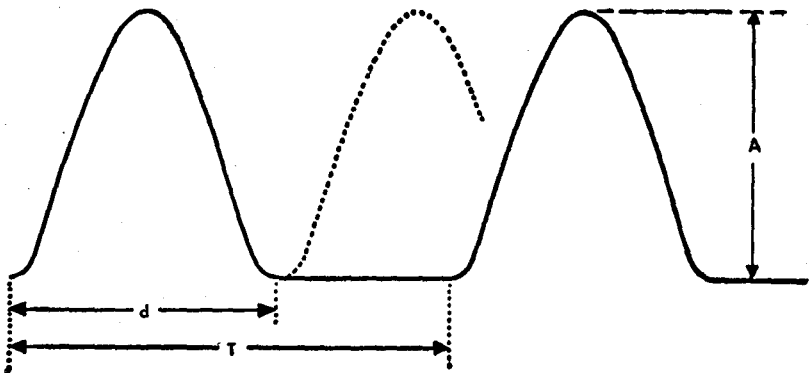
10. Full sine-wave

$$A_{av} = \frac{Ad}{2T}$$

$$A_{rms} = \frac{A}{2} \sqrt{\frac{3d}{2T}}$$

$$C_n = A_{av} \left[2 \frac{\sin \left(n\pi \frac{d}{T}\right)}{n\pi \frac{d}{T}} + \frac{\sin \pi \left(1 - n \frac{d}{T}\right)}{\pi \left(1 - n \frac{d}{T}\right)} + \frac{\sin \pi \left(1 + n \frac{d}{T}\right)}{\pi \left(1 + n \frac{d}{T}\right)} \right]$$

Analyses of commonly encountered wave forms *continued*

11. Critically damped exponential wave

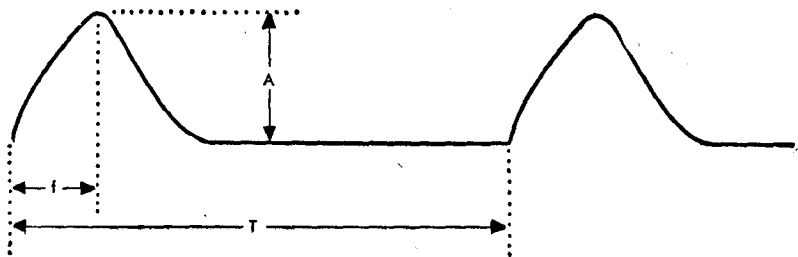

$$f(t) = \frac{A\epsilon}{f} t\epsilon^{-\frac{t}{T}} \quad \text{where } \epsilon = 2.718 \text{ for } T > 10f$$

$$A_{rms} = \frac{A\epsilon}{\sqrt{2}} \sqrt{\frac{f}{T}}$$

$$A_{av} = \frac{A\epsilon f}{T}$$

$$C_n = 2A_{av} \left[\frac{1}{1 + \left(\frac{2\pi n f}{T}\right)^2} \right] = 2A_{av} \cos^2 \frac{\theta_n}{2}$$

$$\frac{\theta_n}{2} = \tan^{-1} \left(\frac{2\pi n f}{T} \right)$$

12. Full-wave rectified sine-wave

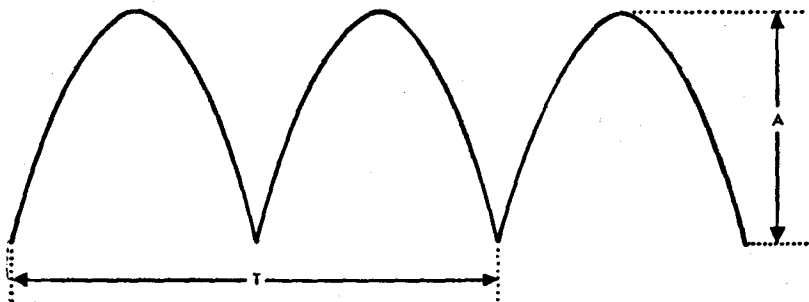

$$A_{av} = \frac{2A}{\pi}$$

$$A_{rms} = \frac{A}{\sqrt{2}}$$

$$C_n = \frac{\pi}{2} A_{av} \left[\frac{\sin \frac{\pi}{2} (1 - n)}{\frac{\pi}{2} (1 - n)} + \frac{\sin \frac{\pi}{2} (1 + n)}{\frac{\pi}{2} (1 + n)} \right]$$

Modulated wave forms

Starting from a carrier $i = A \sin \theta$ modulated waveforms are obtained when either or both A and θ are functions of time.

1. Amplitude modulation

$\theta = \omega t + \phi$ where ω and ϕ are constants

$$A = A_0[1 + m_a f(t)]$$

$$i = A_0[1 + m_a f(t)] \sin(\omega t + \phi)$$

where $f(t)$ is a continuous function of time representing the signal and $|f(t)| \leq 1$. Then m_a is the degree of amplitude modulation; $0 \leq m_a \leq 1$. Generally the frequency spectrum of $f(t)$ will be limited up to a value $\alpha \ll \omega$ and the total frequency spectrum will comprise:

the carrier ω

the lower side band from ω to $\omega - \alpha$

the upper side band from ω to $\omega + \alpha$

For correct transmission of intelligence it is sufficient to transmit one of the side bands only.

For a sinusoidal signal $f(t) = \cos pt$ where $p =$ angular frequency of the signal; $i = A_0 \left\{ \sin \omega t + \frac{m_a}{2} [\sin(\omega + p)t + \sin(\omega - p)t] \right\}$

2. Frequency modulation

wherein A is constant

$$\omega_t = \frac{d\theta}{dt} = \omega[1 + mf(t)]$$

$\omega = 2\pi \times$ mean carrier frequency (a constant), $\omega_t = 2\pi \times$ instantaneous frequency, $m =$ degree of frequency modulation, $\Delta\omega = m\omega = 2\pi \times$ frequency swing, $f(t)$ is the signal to be transmitted; $|f(t)| \leq 1$.

Even when the frequency spectrum of $f(t)$ extends only up to $\alpha \ll \omega$ the resulting frequency spectrum of the modulated wave is complex, depending on the relative values of α and m . Generally $\Delta\omega \geq \alpha$ and the spectrum is composed of groups of upper and lower side bands even when $f(t)$ is a sinusoidal function of time.

For a sinusoidal signal $f(t) = \cos pt$

$$\omega_t = \omega[1 + m \cos pt]$$

$$\theta = \omega t + \frac{\Delta\omega}{p} \sin pt$$

$$m_f = \frac{\Delta\omega}{p} = \text{frequency modulation index (radians)}$$

Modulated wave forms *continued*

In this case the carrier and side bands include a number of components at frequencies $(\omega \pm n\pi)/2\pi$ where $n = 0$ or a positive integer.

$$\begin{aligned} \frac{i}{A_0} &= \sin(\omega t + m_f \sin pt) \\ &= J_0(m_f) \sin \omega t \\ &\quad + J_1(m_f) [\sin(\omega + p)t - \sin(\omega - p)t] \\ &\quad + J_2(m_f) [\sin(\omega + 2p)t + \sin(\omega - 2p)t] \\ &\quad + \dots \\ &\quad + J_n(m_f) [\sin(\omega + np)t + (-1)^n \sin(\omega - np)t] \\ &= J_0(m_f) \sin \omega t + 2J_1(m_f) \sin pt \cos \omega t \\ &\quad + 2J_2(m_f) \cos 2pt \sin \omega t + \dots \\ &\quad + (-1)^n 2J_n(m_f) \cos\left(np t + \frac{\pi}{2}\right) \sin\left(\omega t + \frac{\pi}{2}\right) \end{aligned}$$

Where $J_n(m_f)$ is the Bessel function of the first kind and n^{th} order. An expansion of $J_n(m_f)$ in a series is given on page 299 and tables of Bessel functions on pages 319 to 322.

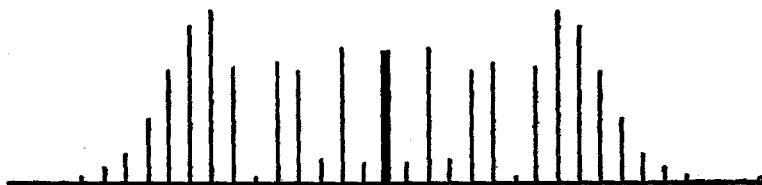

Amplitude of carrier and side bands for $m_f = 10$. The carrier amplitude is $0.246 A_0$ and is represented by the heavy line in the center. The separation between each two adjacent components = signal frequency f .

a. For small values of m_f up to about 0.2

$$\begin{aligned} i &= A_0 \left\{ \sin \omega t + \frac{m_f}{2} [\sin(\omega + p)t - \sin(\omega - p)t] \right\} \\ &= A_0 (\sin \omega t + m_f \sin pt \cos \omega t) \end{aligned}$$

Compare with amplitude modulation above.

b. The carrier amplitude varies with m_f as does also that of each pair of side bands.

Carrier vanishes for $m_f =$	2.40	5.52	8.65	11.79	14.93 etc.
First side band vanishes for $m_f =$	3.83	7.02	10.17	13.32 etc.	

This property of vanishing components is used frequently in the measurement of m_f .

Modulated wave forms *continued*

c. The approximate number of important side bands and the corresponding band width necessary for transmission are as follows (where $f = p/2\pi$ and $\Delta F = \Delta\omega/2\pi$):

m_f	5	10	20
signal frequency f	$0.2\Delta F$	$0.1\Delta F$	$0.05\Delta F$
number of pairs of side bands	7	13	23
band width	$14f$ $2.8\Delta F$	$26f$ $2.6\Delta F$	$46f$ $2.3\Delta F$

This table is based on neglecting side bands in the outer regions where all amplitudes are less than $0.02 A_0$. The amplitude below which the side bands are neglected, and the resultant band width, will depend on the particular application and the quality of transmission desired.

3. Pulse modulation

Pulse modulation is obtained when A or $\frac{d\theta}{dt}$ are keyed periodically. Then

$f(t)$ is generally a pulsing waveform of the type previously described. See 4, page 283 (with $f \ll T$).

In pulse modulation generally $f(t)$ has no simple relation to the signal to be transmitted. Various forms of pulse modulation have been described:

- a. Pulse-time modulation: The timing of the pulse $f(t)$ relative to a reference pulse is varied around a fixed mean value and conforms to the amplitude of the signal to be transmitted.
- b. Pulse-width modulation: The duration of the pulse $f(t)$ is varied around a fixed mean value and conforms to the amplitude of the signal to be transmitted.
- c. Pulse-frequency modulation: The repetition rate of the pulse $f(t)$ is varied around a fixed mean value and conforms to the amplitude of the signal to be transmitted.

■ Mathematical formulas

Mensuration formulas

Areas of plane figures

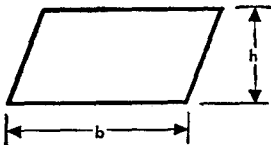
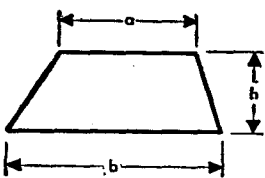
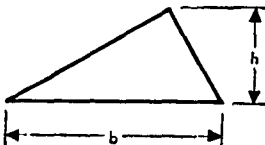
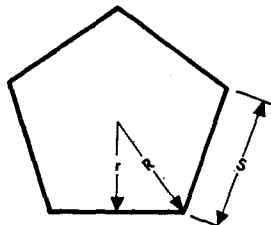
figure	formula
<p>Parallelogram</p> 	<p>Area = bh</p>
<p>Trapezoid</p> 	<p>Area = $\frac{1}{2}h(a + b)$</p>
<p>Triangle</p> 	<p>Area = $\frac{1}{2}bh$</p>
<p>Regular polygons</p> 	<p>Area = $nr^2 \tan \frac{180^\circ}{n}$ $= \frac{n}{4} S^2 \cot \frac{180^\circ}{n}$ $= \frac{n}{2} R^2 \sin \frac{360^\circ}{n}$ n = number of sides r = short radius S = length of one side R = long radius</p>

Mensuration formulas *continued***Areas of plane figures**

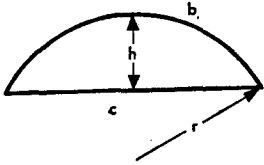
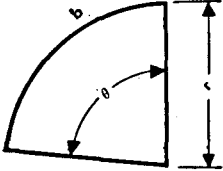
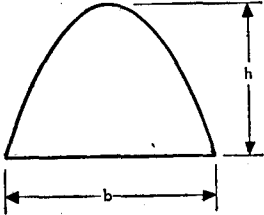
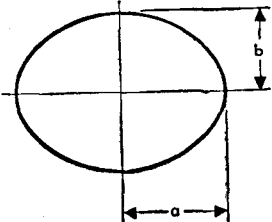
figure	formula
<p>Circle</p>	<p>Area = πr^2 r = radius π = 3.141593</p>
<p>Segment of circle</p> 	<p>Area = $\frac{1}{2}[br - c(r - h)]$ b = length of arc c = length of chord $= \sqrt{4(2hr - h^2)}$</p>
<p>Sector of circle</p> 	<p>Area = $\frac{br}{2} = \pi r^2 \frac{\theta}{360^\circ}$</p>
<p>Parabola</p> 	<p>Area = $\frac{2}{3}bh$</p>
<p>Ellipse</p> 	<p>Area = πab</p>

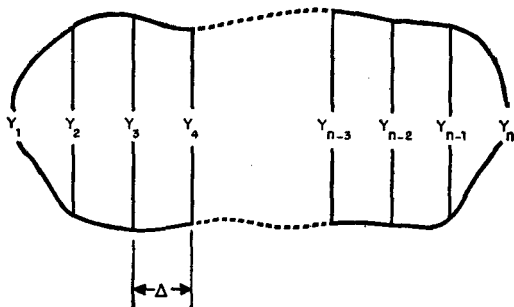
Mensuration formulas *continued*
Area of irregular plane surface

Trapezoidal rule:

$$\text{Area} = \Delta \left(\frac{y_1}{2} + y_2 + y_3 + \dots + y_{n-2} + y_{n-1} + \frac{y_n}{2} \right)$$

Simpson's rule:

n must be odd

$$\text{Area} = \frac{\Delta}{3} (y_1 + 4y_2 + 2y_3 + 4y_4 + 2y_5 + \dots + 2y_{n-2} + 4y_{n-1} + y_n)$$

$y_1, y_2, y_3 \dots y_n$ are measured lengths of a series of equidistant parallel chords

Volumes and surface areas

Sphere: Surface = $4\pi r^2$

$$\text{Volume} = \frac{4\pi r^3}{3}$$

r = radius of sphere

Cylinder: Cylindrical portion of surface = $2\pi rh$

$$\text{Volume} = \pi r^2 h$$

r = radius of cylinder

h = height of cylinder

Pyramid or cone: Volume = Area of base $\times \frac{1}{3}$ of height

Formulas for complex quantities

$$(A + jB)(C + jD) = (AC - BD) + j(BC + AD)$$

$$\frac{A + jB}{C + jD} = \frac{AC + BD}{C^2 + D^2} + j \frac{BC - AD}{C^2 + D^2}$$

$$\frac{1}{A + jB} = \frac{A}{A^2 + B^2} - j \frac{B}{A^2 + B^2}$$

$$A + jB = \rho(\cos \theta + j \sin \theta)$$

$$\sqrt{A + jB} = \pm \sqrt{\rho} \left(\cos \frac{\theta}{2} + j \sin \frac{\theta}{2} \right)$$

$$\text{where } \rho = \sqrt{A^2 + B^2}; \quad \cos \theta = \frac{A}{\rho}$$

$$\sin \theta = \frac{B}{\rho}$$

$$e^{j\theta} = \cos \theta + j \sin \theta$$

$$e^{-j\theta} = \cos \theta - j \sin \theta$$

Algebraic and trigonometric formulas

$$1 = \sin^2 A + \cos^2 A = \sin A \operatorname{cosec} A = \tan A \cot A = \cos A \sec A$$

$$\sin A = \frac{\cos A}{\cot A} = \frac{1}{\operatorname{cosec} A} = \cos A \tan A = \sqrt{1 - \cos^2 A}$$

$$\cos A = \frac{\sin A}{\tan A} = \frac{1}{\sec A} = \sin A \cot A = \sqrt{1 - \sin^2 A}$$

$$\tan A = \frac{\sin A}{\cos A} = \frac{1}{\cot A} = \sin A \sec A$$

$$\cot A = \frac{1}{\tan A} \quad \sec A = \frac{1}{\cos A}$$

$$\operatorname{cosec} A = \frac{1}{\sin A}$$

$$\sin(A \pm B) = \sin A \cos B \pm \cos A \sin B$$

$$\tan(A \pm B) = \frac{\tan A \pm \tan B}{1 \mp \tan A \tan B}$$

Algebraic and trigonometric formulas *continued*

$$\cos (A \pm B) = \cos A \cos B \mp \sin A \sin B$$

$$\cot (A \pm B) = \frac{\cot A \cot B \mp 1}{\cot B \pm \cot A}$$

$$\sin A + \sin B = 2 \sin \frac{1}{2} (A + B) \cos \frac{1}{2} (A - B)$$

$$\sin^2 A - \sin^2 B = \sin (A + B) \sin (A - B)$$

$$\tan A \pm \tan B = \frac{\sin (A \pm B)}{\cos A \cos B}$$

$$\sin A - \sin B = 2 \cos \frac{1}{2} (A + B) \sin \frac{1}{2} (A - B)$$

$$\cos A + \cos B = 2 \cos \frac{1}{2} (A + B) \cos \frac{1}{2} (A - B)$$

$$\cot A \pm \cot B = \frac{\sin (B \pm A)}{\sin A \sin B}$$

$$\cos B - \cos A = 2 \sin \frac{1}{2} (A + B) \sin \frac{1}{2} (A - B)$$

$$\sin 2A = 2 \sin A \cos A \quad \cos 2A = \cos^2 A - \sin^2 A$$

$$\cos^2 A - \sin^2 B = \cos (A + B) \cos (A - B)$$

$$\tan 2A = \frac{2 \tan A}{1 - \tan^2 A}$$

$$\sin \frac{1}{2} A = \pm \sqrt{\frac{1 - \cos A}{2}} \quad \cos \frac{1}{2} A = \pm \sqrt{\frac{1 + \cos A}{2}}$$

$$\tan \frac{1}{2} A = \frac{\sin A}{1 + \cos A} \quad \sin^2 A = \frac{1 - \cos 2A}{2}$$

$$\cos^2 A = \frac{1 + \cos 2A}{2} \quad \tan^2 A = \frac{1 - \cos 2A}{1 + \cos 2A}$$

$$\frac{\sin A \pm \sin B}{\cos A + \cos B} = \tan \frac{1}{2} (A \pm B)$$

$$\frac{\sin A \pm \sin B}{\cos B - \cos A} = \cot \frac{1}{2} (A \mp B)$$

$$\sin A \cos B = \frac{1}{2} [\sin (A + B) + \sin (A - B)]$$

$$\cos A \cos B = \frac{1}{2} [\cos (A + B) + \cos (A - B)]$$

$$\sin A \sin B = \frac{1}{2} [\cos (A - B) - \cos (A + B)]$$

Algebraic and trigonometric formulas *continued*

$$\sin x + \sin 2x + \sin 3x + \dots + \sin mx = \frac{\sin \frac{1}{2} mx \sin \frac{1}{2} (m+1) x}{\sin \frac{1}{2} x}$$

$$\cos x + \cos 2x + \cos 3x + \dots + \cos mx = \frac{\sin \frac{1}{2} mx \cos \frac{1}{2} (m+1) x}{\sin \frac{1}{2} x}$$

$$\sin x + \sin 3x + \sin 5x + \dots + \sin (2m-1) x = \frac{\sin^2 mx}{\sin x}$$

$$\cos x + \cos 3x + \cos 5x + \dots + \cos (2m-1) x = \frac{\sin 2mx}{2 \sin x}$$

$$\frac{1}{2} + \cos x + \cos 2x + \dots + \cos mx = \frac{\sin (m + \frac{1}{2}) x}{2 \sin \frac{1}{2} x}$$

angle	0	30°	45°	60°	90°	180°	270°	360°
sin	0	1/2	1/2√2	1/2√3	1	0	-1	0
cos	1	1/2√3	1/2√2	1/2	0	-1	0	1
tan	0	1/3√3	1	√3	±∞	0	±∞	0

$$\text{versine } \theta = 1 - \cos \theta$$

$$\sin 14\frac{1}{2}^\circ = \frac{1}{4} \text{ approximately}$$

$$\sin 20^\circ = \frac{11}{32} \text{ approximately}$$

Approximations for small angles

$$\sin \theta = (\theta - \theta^3/6 \dots) \quad \theta \text{ in radians}$$

$$\tan \theta = (\theta + \theta^3/3 \dots) \quad \theta \text{ in radians}$$

$$\cos \theta = (1 - \theta^2/2 \dots) \quad \theta \text{ in radians}$$

Quadratic equation

$$\text{If } ax^2 + bx + c = 0, \text{ then } x = \frac{-b \pm \sqrt{b^2 - 4ac}}{2a}$$

Arithmetical progression

$$S = n(a + l) / 2 = n[2a + (n-1)d] / 2$$

where S = sum, a = first term, l = last term, n = number of terms, d = common difference = the value of any term minus the value of the preceding term.

Geometrical progression

$$S = \frac{a(r^n - 1)}{r - 1} = \frac{a(1 - r^n)}{1 - r}$$

where S = sum, a = first term, n = number of terms, r = common ratio = the value of any term divided by the preceding term.

Combinations and permutations

The number of combinations of n things, all different, taken r at a time is

$${}^n C_r = \frac{n!}{r! (n - r)!}$$

The number of permutations of n things r at a time = ${}^n P_r$

$${}^n P_r = n(n - 1)(n - 2) \dots (n - r + 1) = \frac{n!}{(n - r)!}$$

$${}^n P_n = n!$$

Binomial theorem

$$(a \pm b)^n = a^n \pm na^{n-1}b + \frac{n(n-1)}{2!} a^{n-2}b^2 \pm \frac{n(n-1)(n-2)}{3!} a^{n-3}b^3 + \dots$$

If n is a positive integer, the series is finite and contains $n + 1$ terms; otherwise it is infinite, converging for $\left| \frac{b}{a} \right| < 1$ and diverging for $\left| \frac{b}{a} \right| > 1$.

Maclaurin's theorem

$$f(x) = f(0) + xf'(0) + \frac{x^2}{1 \cdot 2} f''(0) + \dots + \frac{x^h}{n!} f^n(0) + \dots$$

Taylor's theorem

$$f(x) = f(x_0) + f'(x_0)(x - x_0) + \frac{f''(x_0)}{2!} (x - x_0)^2 + \dots$$

$$f(x + h) = f(x) + f'(x) \cdot h + \frac{f''(x)}{2!} h^2 + \dots + \frac{f^n(x)}{n!} h^n + \dots$$

Trigonometric solution of triangles

Right-angled triangles (right angle at C)

$$\sin A = \cos B = \frac{a}{c}$$

$$\tan A = \frac{a}{b} \quad B = 90^\circ - A$$

$$\text{vers } A = 1 - \cos A = \frac{c - b}{c}$$

$$c = \sqrt{a^2 + b^2}$$

$$b = \sqrt{c^2 - a^2} = \sqrt{(c + a)(c - a)}$$

$$\text{Area} = \frac{ab}{2} = \frac{a}{2} \sqrt{c^2 - a^2} = \frac{a^2 \cot A}{2} = \frac{b^2 \tan A}{2} = \frac{c^2 \sin A \cos A}{2}$$

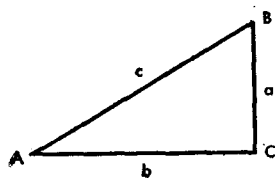

Oblique-angled triangles

$$\sin \frac{1}{2} A = \sqrt{\frac{(s - b)(s - c)}{bc}}$$

$$\cos \frac{1}{2} A = \sqrt{\frac{s(s - a)}{bc}}$$

$$\text{where } s = \frac{a + b + c}{2}$$

$$\tan \frac{1}{2} A = \sqrt{\frac{(s - b)(s - c)}{s(s - a)}}, \text{ similar values for angles B and C}$$

$$\text{Area} = \sqrt{s(s - a)(s - b)(s - c)} = \frac{1}{2} ab \sin C = \frac{a^2 \sin B \sin C}{2 \sin A}$$

$$c = \frac{a \sin C}{\sin A} = \frac{a \sin (A + B)}{\sin A} = \sqrt{a^2 + b^2 - 2ab \cos C}$$

$$\tan A = \frac{a \sin C}{b - a \cos C}, \quad \tan \frac{1}{2} (A - B) = \frac{a - b}{a + b} \cot \frac{1}{2} C$$

$a^2 = b^2 + c^2 - 2bc \cos A$, similar expressions for other sides.

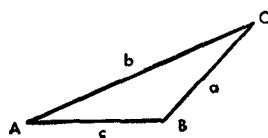

$$A + B + C = 180^\circ$$

Complex hyperbolic and other functions

Properties of "e"

$$e = 1 + 1 + \frac{1}{2!} + \frac{1}{3!} + \dots = 2.71828$$

$$\frac{1}{e} = 0.3679$$

$$e^x = 1 + x + \frac{x^2}{2!} + \frac{x^3}{3!} + \dots$$

$$\log_{10} e = 0.43429; \log_e 10 = 2.30259$$

$$\log_e N = \log_e 10 \times \log_{10} N; \log_{10} N = \log_{10} e \times \log_e N.$$

$$\left. \begin{aligned} \sin x &= x - \frac{x^3}{3!} + \frac{x^5}{5!} - \frac{x^7}{7!} + \dots \\ \cos x &= 1 - \frac{x^2}{2!} + \frac{x^4}{4!} - \frac{x^6}{6!} + \dots \\ \sinh x &= x + \frac{x^3}{3!} + \frac{x^5}{5!} + \frac{x^7}{7!} + \dots \\ \cosh x &= 1 + \frac{x^2}{2!} + \frac{x^4}{4!} + \frac{x^6}{6!} + \dots \end{aligned} \right\} \begin{array}{l} x \text{ is in radians. The series are con-} \\ \text{vergent for all finite values of } x. \end{array}$$

For $n = 0$ or a positive integer, the expansion of the Bessel function of the first kind, n^{th} order, is given by the convergent series

$$J_n(x) = \frac{x^n}{2^n n!} \left[1 - \frac{x^2}{2(2n+2)} + \frac{x^4}{2 \cdot 4(2n+2)(2n+4)} - \frac{x^6}{2 \cdot 4 \cdot 6(2n+2)(2n+4)(2n+6)} + \dots \right]$$

$$\text{and } J_{-n}(x) = (-1)^n J_n(x)$$

Note: $0! = 1$

$$\sin x = \frac{e^{jx} - e^{-jx}}{2j}$$

$$e^{jx} = \cos x + j \sin x$$

$$e^{-jx} = \cos x - j \sin x$$

$$\cos x = \frac{e^{jx} + e^{-jx}}{2}$$

$$j = \sqrt{-1}$$

$$\sinh(-x) = -\sinh x; \cosh(-x) = \cosh x$$

$$\sinh jx = j \sin x; \cosh jx = \cos x$$

$$\sinh x = \frac{e^x - e^{-x}}{2}$$

$$\cosh^2 x - \sinh^2 x = 1$$

$$\sinh 2x = 2 \sinh x \cosh x$$

$$\cosh 2x = \cosh^2 x + \sinh^2 x$$

$$\cosh x = \frac{e^x + e^{-x}}{2}$$

$$\sinh(x \pm jy) = \sinh x \cos y \pm j \cosh x \sin y$$

$$\cosh(x \pm jy) = \cosh x \cos y \pm j \sinh x \sin y$$

Table of integrals**Indefinite integrals**

In the following formulas, a , b , and m are constants. The constant of integration is not shown, but is added to each result.

$$\int dx = x$$

$$\int af(x) dx = a \int f(x) dx$$

$$\int (u + v - s) dx = \int u dx + \int v dx - \int s dx$$

$$\int x^m dx = \frac{x^{m+1}}{m+1} \quad m \neq -1$$

$$\int \frac{dx}{x} = \log_e x$$

$$\int (ax + b)^m dx = \frac{(ax + b)^{m+1}}{a(m+1)} \quad m \neq -1$$

$$\int \frac{dx}{ax + b} = \frac{1}{a} \log_e (ax + b)$$

$$\int \frac{xdx}{ax + b} = \frac{1}{a^2} [ax + b - b \log_e (ax + b)]$$

$$\int \frac{xdx}{(ax + b)^2} = \frac{1}{a^2} \left[\frac{b}{ax + b} + \log_e (ax + b) \right]$$

$$\int \frac{x^2 dx}{ax + b} = \frac{1}{a^3} \left[\frac{(ax + b)^2}{2} - 2b(ax + b) + b^2 \log_e (ax + b) \right]$$

$$\int \frac{dx}{x^2 + a^2} = \frac{1}{a} \tan^{-1} \frac{x}{a}$$

$$\int \frac{dx}{\sqrt{a^2 - x^2}} = \sin^{-1} \frac{x}{a}$$

$$\int \log_a x dx = x \log_a \frac{x}{e} \quad \text{where } e = 2.718$$

$$\int a^x dx = \frac{a^x}{\log_e a}$$

Table of integrals *continued*

$$\int x e^x dx = e^x (x - 1)$$

$$\int x^m e^x dx = x^m e^x - m \int x^{m-1} e^x dx$$

$$\int \sin x dx = -\cos x$$

$$\int \sin^2 x dx = \frac{1}{2} (x - \sin x \cos x)$$

$$\int \cos x dx = \sin x$$

$$\int \cos^2 x dx = \frac{1}{2} (x + \sin x \cos x)$$

$$\int \tan x dx = -\log_e \cos x$$

$$\int \cot x dx = \log_e \sin x$$

$$\int \sec x dx = \log_e (\sec x + \tan x)$$

$$\int \sec^2 x dx = \tan x$$

$$\int \operatorname{cosec}^2 x dx = -\cot x$$

$$\int \operatorname{cosec} x dx = \log_e (\operatorname{cosec} x - \cot x)$$

$$\int \sin^{-1} x dx = x \sin^{-1} x + \sqrt{1 - x^2}$$

$$\int \cos^{-1} x dx = x \cos^{-1} x - \sqrt{1 - x^2}$$

$$\int \tan^{-1} x dx = x \tan^{-1} x - \log_e \sqrt{1 + x^2}$$

Table of integrals *continued***Definite integrals**

$$\int_0^{\infty} x^{n-1} e^{-x} dx = \Gamma(n)^*$$

$$\int_0^1 x^{m-1} (1-x)^{n-1} dx = \frac{\Gamma(m)\Gamma(n)^*}{\Gamma(m+n)}$$

$$\int_0^{\frac{\pi}{2}} \sin^n x dx = \int_0^{\frac{\pi}{2}} \cos^n x dx = \frac{1}{2} \sqrt{\pi} \frac{\Gamma\left(\frac{n+1}{2}\right)^*}{\Gamma\left(\frac{n}{2}+1\right)}, n > -1$$

$$\int_0^{\infty} \frac{\sin mx dx}{x} = \frac{\pi}{2} \text{ if } m > 0; 0 \text{ if } m = 0; -\frac{\pi}{2} \text{ if } m < 0$$

$$\int_0^{\infty} \frac{\cos mx dx}{1+x^2} = \frac{\pi}{2} e^{-|m|}$$

$$\int_0^{\infty} \frac{\cos x dx}{\sqrt{x}} = \int_0^{\infty} \frac{\sin x dx}{\sqrt{x}} = \sqrt{\frac{\pi}{2}}$$

$$\int_0^{\infty} e^{-a^2 x^2} dx = \frac{1}{2a} \sqrt{\pi}$$

$$\int_{-\frac{\pi}{2}}^{\frac{\pi}{2}} \frac{\cos^2\left(\frac{\pi}{2} \sin x\right) dx}{\cos x} = 1.22$$

* Values of $\Gamma(n)$ are tabulated in Jahnke & Emde, Tables of Functions.

Exponentials [e^n and e^{-n}]

Mathematical tables

n	e^n	diff	n	e^n	diff	n	e^n	n	e^{-n}	diff	n	e^{-n}	n	e^{-n}	n	e^{-n}
0.00	1.000		0.50	1.649	16	1.0	2.718*	0.00	1.000	-10	0.50	.607	1.0	.368*		
.01	1.010	10	.51	1.665	17	.1	3.004	.01	0.990	-10	.51	.600	.1	.333		
.02	1.020	10	.52	1.682	17	.2	3.320	.02	.980	-10	.52	.595	.2	.301		
.03	1.030	10	.53	1.699	17	.3	3.669	.03	.970	-10	.53	.589	.3	.273		
.04	1.041	10	.54	1.716	17	.4	4.055	.04	.961	-10	.54	.583	.4	.247		
0.05	1.051	11	0.55	1.733	18	1.5	4.482	0.05	.951	-9	0.55	.577	1.5	.223		
.06	1.062	11	.56	1.751	17	.6	4.953	.06	.942	-10	.56	.571	.6	.202		
.07	1.073	10	.57	1.768	18	.7	5.474	.07	.932	-9	.57	.566	.7	.183		
.08	1.083	11	.58	1.786	18	.8	6.050	.08	.923	-9	.58	.560	.8	.165		
.09	1.094	11	.59	1.804	18	.9	6.686	.09	.914	-9	.59	.554	.9	.150		
0.10	1.105	11	0.60	1.822	18	2.0	7.389	0.10	.905	-9	0.60	.549	2.0	.135		
.11	1.116	11	.61	1.840	19	.1	8.166	.11	.896	-9	.61	.543	.1	.122		
.12	1.127	12	.62	1.859	19	.2	9.025	.12	.887	-9	.62	.538	.2	.111		
.13	1.139	12	.63	1.878	19	.3	9.974	.13	.878	-9	.63	.533	.3	.100		
.14	1.150	12	.64	1.896	18	.4	11.02	.14	.869	-9	.64	.527	.4	.0907		
0.15	1.162	12	0.65	1.916	19	2.5	12.18	0.15	.861	-9	0.65	.522	2.5	.0821		
.16	1.174	11	.66	1.935	19	.6	13.46	.16	.852	-8	.66	.517	.6	.0743		
.17	1.185	12	.67	1.954	20	.7	14.88	.17	.844	-9	.67	.512	.7	.0672		
.18	1.197	12	.68	1.974	20	.8	16.44	.18	.835	-8	.68	.507	.8	.0608		
.19	1.209	12	.69	1.994	20	.9	18.17	.19	.827	-8	.69	.502	.9	.0550		
0.20	1.221	13	0.70	2.014	20	3.0	20.09	0.20	.819	-8	0.70	.497	3.0	.0498		
.21	1.234	12	.71	2.034	20	.1	22.20	.21	.811	-8	.71	.492	.1	.0450		
.22	1.246	12	.72	2.054	20	.2	24.53	.22	.803	-8	.72	.487	.2	.0408		
.23	1.259	13	.73	2.075	21	.3	27.11	.23	.795	-8	.73	.482	.3	.0369		
.24	1.271	13	.74	2.096	21	.4	29.96	.24	.787	-8	.74	.477	.4	.0334		
0.25	1.284	13	0.75	2.117	21	3.5	33.12	0.25	.779	-8	0.75	.472	3.5	.0302		
.26	1.297	13	.76	2.138	22	.6	36.60	.26	.771	-8	.76	.468	.6	.0273		
.27	1.310	13	.77	2.160	21	.7	40.45	.27	.763	-7	.77	.463	.7	.0247		
.28	1.323	13	.78	2.181	22	.8	44.70	.28	.756	-8	.78	.458	.8	.0224		
.29	1.336	14	.79	2.203	23	.9	49.40	.29	.748	-7	.79	.454	.9	.0202		
0.30	1.350	13	0.80	2.226	22	4.0	54.60	0.30	.741	-8	0.80	.449	4.0	.0183		
.31	1.363	14	.81	2.248	22	.1	60.34	.31	.733	-8	.81	.445	.1	.0166		
.32	1.377	14	.82	2.270	22	.2	66.69	.32	.726	-7	.82	.440	.2	.0150		
.33	1.391	14	.83	2.293	23	.3	73.70	.33	.719	-7	.83	.436	.3	.0136		
.34	1.405	14	.84	2.316	24	.4	81.45	.34	.712	-7	.84	.432	.4	.0123		
0.35	1.419	14	0.85	2.340	23	4.5	90.02	0.35	.705	-7	0.85	.427	4.5	.0111		
.36	1.433	15	.86	2.363	24	.6	98.98	.36	.698	-7	.86	.423	.6	.0098		
.37	1.448	14	.87	2.387	24	.7	108.4	.37	.691	-7	.87	.419	.7	.0087		
.38	1.462	15	.88	2.411	24	.8	118.4	.38	.684	-7	.88	.415	.8	.0078		
.39	1.477	15	.89	2.435	25	.9	129.1	.39	.677	-7	.89	.411	.9	.0070		
0.40	1.492	15	0.90	2.460	24	8.0	2981.	0.40	.670	-6	0.90	.407	8.0	.00335		
.41	1.507	15	.91	2.484	25	9.0	8103.	.41	.664	-7	.91	.403	9.0	.00123		
.42	1.522	15	.92	2.509	26	10.0	22026.	.42	.657	-7	.92	.399	10.0	.00045		
.43	1.537	16	.93	2.535	25	$\pi/2$	4.810	.43	.651	-6	.93	.395	$\pi/2$.208		
.44	1.553	16	.94	2.560	26	$2\pi/2$	23.14	.44	.644	-6	.94	.391	$2\pi/2$.0432		
0.45	1.568	16	0.95	2.586	26	$3\pi/2$	111.3	0.45	.638	-7	0.95	.387	$3\pi/2$.00898		
.46	1.584	16	.96	2.612	26	$4\pi/2$	535.5	.46	.631	-6	.96	.383	$4\pi/2$.00187		
.47	1.600	16	.97	2.638	26	$5\pi/2$	2576.	.47	.625	-6	.97	.379	$5\pi/2$.000388		
.48	1.616	16	.98	2.664	27	$6\pi/2$	12392.	.48	.619	-6	.98	.375	$6\pi/2$.000081		
.49	1.632	17	.99	2.691	27	$7\pi/2$	59610.	.49	.613	-6	.99	.372	$7\pi/2$.000017		
0.50	1.649		1.00	2.718		$8\pi/2$	286751.	0.50	0.607		1.00	.368	$8\pi/2$.000003		

* Note: Do not interpolate in this column.
 $e = 2.71828$ $1/e = 0.367879$ $\log_{10} e = 0.4343$ $1/(0.4343) = 2.3026$
 $\log_{10}(0.4343) = 9.6378 - 10$ $\log_{10}(e^n) = n(0.4343)$

Common logarithms of numbers and proportional parts

											proportional parts								
	0	1	2	3	4	5	6	7	8	9	1	2	3	4	5	6	7	8	9
10	0000	0043	0086	0128	0170	0212	0253	0294	0334	0374	4	8	12	17	21	25	29	33	37
11	0414	0453	0492	0531	0569	0607	0645	0682	0719	0755	4	8	11	15	19	23	26	30	34
12	0792	0828	0864	0899	0934	0969	1004	1038	1072	1106	3	7	10	14	17	21	24	28	31
13	1139	1173	1206	1239	1271	1303	1335	1367	1399	1430	3	6	10	13	16	19	23	26	29
14	1461	1492	1523	1553	1584	1614	1644	1673	1703	1732	3	6	9	12	15	18	21	24	27
15	1761	1790	1818	1847	1875	1903	1931	1959	1987	2014	3	6	8	11	14	17	20	22	25
16	2041	2068	2095	2122	2148	2175	2201	2227	2253	2279	3	5	8	11	13	16	18	21	24
17	2304	2330	2355	2380	2405	2430	2455	2480	2504	2529	2	5	7	10	12	15	17	20	22
18	2553	2577	2601	2625	2648	2672	2695	2718	2742	2765	2	5	7	9	12	14	16	19	21
19	2788	2810	2833	2856	2878	2900	2923	2945	2967	2989	2	4	7	9	11	13	16	18	20
20	3010	3032	3054	3075	3096	3118	3139	3160	3181	3201	2	4	6	8	11	13	15	17	19
21	3222	3243	3263	3284	3304	3324	3345	3365	3385	3404	2	4	6	8	10	12	14	16	18
22	3424	3444	3464	3483	3502	3522	3541	3560	3579	3598	2	4	6	8	10	12	14	15	17
23	3617	3636	3655	3674	3692	3711	3729	3747	3766	3784	2	4	6	7	9	11	13	15	17
24	3802	3820	3838	3856	3874	3892	3909	3927	3945	3962	2	4	5	7	9	11	12	14	16
25	3979	3997	4014	4031	4048	4065	4082	4099	4116	4133	2	3	5	7	9	10	12	14	15
26	4150	4166	4183	4200	4216	4232	4249	4265	4281	4298	2	3	5	7	8	10	11	13	15
27	4314	4330	4346	4362	4378	4393	4409	4425	4440	4456	2	3	5	6	8	9	11	13	14
28	4472	4487	4502	4518	4533	4548	4564	4579	4594	4609	2	3	5	6	8	9	11	12	14
29	4624	4639	4654	4669	4683	4698	4713	4728	4742	4757	1	3	4	6	7	9	10	12	13
30	4771	4786	4800	4814	4829	4843	4857	4871	4886	4900	1	3	4	6	7	9	10	11	13
31	4914	4928	4942	4955	4969	4983	4997	5011	5024	5038	1	3	4	6	7	8	10	11	12
32	5051	5065	5079	5092	5105	5119	5132	5145	5159	5172	1	3	4	5	7	8	9	11	12
33	5185	5198	5211	5224	5237	5250	5263	5276	5289	5302	1	3	4	5	6	8	9	10	12
34	5315	5328	5340	5353	5366	5378	5391	5403	5416	5428	1	3	4	5	6	8	9	10	11
35	5441	5453	5465	5478	5490	5502	5514	5527	5539	5551	1	2	4	5	6	7	9	10	11
36	5563	5575	5587	5599	5611	5623	5635	5647	5658	5670	1	2	4	5	6	7	8	10	11
37	5682	5694	5705	5717	5729	5740	5752	5763	5775	5786	1	2	3	5	6	7	8	9	10
38	5798	5809	5821	5832	5843	5855	5866	5877	5888	5899	1	2	3	5	6	7	8	9	10
39	5911	5922	5933	5944	5955	5966	5977	5988	5999	6010	1	2	3	4	5	7	8	9	10
40	6021	6031	6042	6053	6064	6075	6085	6096	6107	6117	1	2	3	4	5	6	8	9	10
41	6128	6138	6149	6160	6170	6180	6191	6201	6212	6222	1	2	3	4	5	6	7	8	9
42	6232	6243	6253	6263	6274	6284	6294	6304	6314	6325	1	2	3	4	5	6	7	8	9
43	6335	6345	6355	6365	6375	6385	6395	6405	6415	6425	1	2	3	4	5	6	7	8	9
44	6435	6444	6454	6464	6474	6484	6493	6503	6513	6522	1	2	3	4	5	6	7	8	9
45	6532	6542	6551	6561	6571	6580	6590	6599	6609	6618	1	2	3	4	5	6	7	8	9
46	6628	6637	6646	6656	6665	6675	6684	6693	6702	6712	1	2	3	4	5	6	7	7	8
47	6721	6730	6739	6749	6758	6767	6776	6785	6794	6803	1	2	3	4	5	5	6	7	8
48	6812	6821	6830	6839	6848	6857	6866	6875	6884	6893	1	2	3	4	4	5	6	7	8
49	6902	6911	6920	6928	6937	6946	6955	6964	6972	6981	1	2	3	4	4	5	6	7	8
50	6990	6998	7007	7016	7024	7033	7042	7050	7059	7067	1	2	3	3	4	5	6	7	8
51	7076	7084	7093	7101	7110	7118	7126	7135	7143	7152	1	2	3	3	4	5	6	7	8
52	7160	7168	7177	7185	7193	7202	7210	7218	7226	7235	1	2	2	3	4	5	6	7	7
53	7243	7251	7259	7267	7275	7284	7292	7300	7308	7316	1	2	2	3	4	5	6	6	7
54	7324	7332	7340	7348	7356	7364	7372	7380	7388	7396	1	2	2	3	4	5	6	6	7

Common logarithms of numbers and proportional parts *continued*

	0	1	2	3	4	5	6	7	8	9	proportional parts								
											1	2	3	4	5	6	7	8	9
55	7404	7412	7419	7427	7435	7443	7451	7459	7466	7474	1	2	2	3	4	5	5	6	7
56	7482	7490	7497	7505	7513	7520	7528	7536	7543	7551	1	2	2	3	4	5	5	6	7
57	7559	7566	7574	7582	7589	7597	7604	7612	7619	7627	1	2	2	3	4	5	5	6	7
58	7634	7642	7649	7657	7664	7672	7679	7686	7694	7701	1	1	2	3	4	4	5	6	7
59	7709	7716	7723	7731	7738	7745	7752	7760	7767	7774	1	1	2	3	4	4	5	6	7
60	7782	7789	7796	7803	7810	7818	7825	7832	7839	7846	1	1	2	3	4	4	5	6	6
61	7853	7860	7868	7875	7882	7889	7896	7903	7910	7917	1	1	2	3	4	4	5	6	6
62	7924	7931	7938	7945	7952	7959	7966	7973	7980	7987	1	1	2	3	3	4	5	6	6
63	7993	8000	8007	8014	8021	8028	8035	8041	8048	8055	1	1	2	3	3	4	5	5	6
64	8062	8069	8075	8082	8089	8096	8102	8109	8116	8122	1	1	2	3	3	4	5	5	6
65	8129	8136	8142	8149	8156	8162	8169	8176	8182	8189	1	1	2	3	3	4	5	5	6
66	8195	8202	8209	8215	8222	8228	8235	8241	8248	8254	1	1	2	3	3	4	5	5	6
67	8261	8267	8274	8280	8287	8293	8299	8306	8312	8319	1	1	2	3	3	4	5	5	6
68	8325	8331	8338	8344	8351	8357	8363	8370	8376	8382	1	1	2	3	3	4	4	5	6
69	8388	8395	8401	8407	8414	8420	8426	8432	8439	8445	1	1	2	2	3	4	4	5	6
70	8451	8457	8463	8470	8476	8482	8488	8494	8500	8506	1	1	2	2	3	4	4	5	6
71	8513	8519	8525	8531	8537	8543	8549	8555	8561	8567	1	1	2	2	3	4	4	5	5
72	8573	8579	8585	8591	8597	8603	8609	8615	8621	8627	1	1	2	2	3	4	4	5	5
73	8633	8639	8645	8651	8657	8663	8669	8675	8681	8686	1	1	2	2	3	4	4	5	5
74	8692	8698	8704	8710	8716	8722	8727	8733	8739	8745	1	1	2	2	3	4	4	5	5
75	8751	8756	8762	8768	8774	8779	8785	8791	8797	8802	1	1	2	2	3	3	4	5	5
76	8808	8814	8820	8825	8831	8837	8842	8848	8854	8859	1	1	2	2	3	3	4	5	5
77	8865	8871	8876	8882	8887	8893	8899	8904	8910	8915	1	1	2	2	3	3	4	4	5
78	8921	8927	8932	8938	8943	8949	8954	8960	8965	8971	1	1	2	2	3	3	4	4	5
79	8976	8982	8987	8993	8998	9004	9009	9015	9020	9025	1	1	2	2	3	3	4	4	5
80	9031	9036	9042	9047	9053	9058	9063	9069	9074	9079	1	1	2	2	3	3	4	4	5
81	9085	9090	9096	9101	9106	9112	9117	9122	9128	9133	1	1	2	2	3	3	4	4	5
82	9138	9143	9149	9154	9159	9165	9170	9175	9180	9186	1	1	2	2	3	3	4	4	5
83	9191	9196	9201	9206	9212	9217	9222	9227	9232	9238	1	1	2	2	3	3	4	4	5
84	9243	9248	9253	9258	9263	9269	9274	9279	9284	9289	1	1	2	2	3	3	4	4	5
85	9294	9299	9304	9309	9315	9320	9325	9330	9335	9340	1	1	2	2	3	3	4	4	5
86	9345	9350	9355	9360	9365	9370	9375	9380	9385	9390	1	1	2	2	3	3	4	4	5
87	9395	9400	9405	9410	9415	9420	9425	9430	9435	9440	0	1	1	2	2	3	3	4	4
88	9445	9450	9455	9460	9465	9469	9474	9479	9484	9489	0	1	1	2	2	3	3	4	4
89	9494	9499	9504	9509	9513	9518	9523	9528	9533	9538	0	1	1	2	2	3	3	4	4
90	9542	9547	9552	9557	9562	9566	9571	9576	9581	9586	0	1	1	2	2	3	3	4	4
91	9590	9595	9600	9605	9609	9614	9619	9624	9628	9633	0	1	1	2	2	3	3	4	4
92	9638	9643	9647	9652	9657	9661	9666	9671	9675	9680	0	1	1	2	2	3	3	4	4
93	9685	9689	9694	9699	9703	9708	9713	9717	9722	9727	0	1	1	2	2	3	3	4	4
94	9731	9736	9741	9745	9750	9754	9759	9763	9768	9773	0	1	1	2	2	3	3	4	4
95	9777	9782	9786	9791	9795	9800	9805	9809	9814	9818	0	1	1	2	2	3	3	4	4
96	9823	9827	9832	9836	9841	9845	9850	9854	9859	9863	0	1	1	2	2	3	3	4	4
97	9868	9872	9877	9881	9886	9890	9894	9899	9903	9908	0	1	1	2	2	3	3	4	4
98	9912	9917	9921	9926	9930	9934	9939	9943	9948	9952	0	1	1	2	2	3	3	4	4
99	9956	9961	9965	9969	9974	9978	9983	9987	9991	9996	0	1	1	2	2	3	3	4	4

Natural trigonometric functions

for decimal fractions of a degree

deg	sin	cos	tan	cot	deg	sin	cos	tan	cot	deg	sin	cos	tan	cot			
0.0	.00000	1.0000	.00000	∞	90.0	.6.0	.10453	0.9945	.10510	9.514	84.0	.1.0453	0.9945	.10510	9.514	84.0	
.1	.00175	1.0000	.00175	573.0	.9	.1	.10626	.9943	.10687	9.357	.9	.10626	.9943	.10687	9.357	.9	
.2	.00349	1.0000	.00349	286.5	.8	.2	.10800	.9942	.10863	9.205	.8	.10800	.9942	.10863	9.205	.8	
.3	.00524	1.0000	.00524	191.0	.7	.3	.10973	.9940	.11040	9.058	.7	.10973	.9940	.11040	9.058	.7	
.4	.00698	1.0000	.00698	143.24	.6	.4	.11147	.9938	.11217	8.915	.6	.11147	.9938	.11217	8.915	.6	
.5	.00873	1.0000	.00873	114.59	.5	.5	.11320	.9936	.11394	8.777	.5	.11320	.9936	.11394	8.777	.5	
.6	.01047	0.9999	.01047	95.49	.4	.6	.11494	.9934	.11570	8.643	.4	.11494	.9934	.11570	8.643	.4	
.7	.01222	.9999	.01222	81.85	.3	.7	.11667	.9932	.11747	8.513	.3	.11667	.9932	.11747	8.513	.3	
.8	.01396	.9999	.01396	71.62	.2	.8	.11840	.9930	.11924	8.386	.2	.11840	.9930	.11924	8.386	.2	
.9	.01571	.9999	.01571	63.66	.1	.9	.12014	.9928	.12101	8.264	.1	.12014	.9928	.12101	8.264	.1	
1.0	.01745	0.9998	.01746	57.29	89.0	7.0	.12187	0.9925	.12278	8.144	83.0	.12187	0.9925	.12278	8.144	83.0	
.1	.01920	.9998	.01920	52.08	.9	.1	.12360	.9923	.12456	8.028	.9	.12360	.9923	.12456	8.028	.9	
.2	.02094	.9998	.02095	47.74	.8	.2	.12533	.9921	.12633	7.916	.8	.12533	.9921	.12633	7.916	.8	
.3	.02269	.9997	.02269	44.07	.7	.3	.12706	.9919	.12810	7.806	.7	.12706	.9919	.12810	7.806	.7	
.4	.02443	.9997	.02444	40.92	.6	.4	.12880	.9917	.12988	7.700	.6	.12880	.9917	.12988	7.700	.6	
.5	.02618	.9997	.02619	38.19	.5	.5	.13053	.9914	.13165	7.596	.5	.13053	.9914	.13165	7.596	.5	
.6	.02792	.9996	.02793	35.80	.4	.6	.13226	.9912	.13343	7.495	.4	.13226	.9912	.13343	7.495	.4	
.7	.02967	.9996	.02968	33.69	.3	.7	.13399	.9910	.13521	7.396	.3	.13399	.9910	.13521	7.396	.3	
.8	.03141	.9995	.03143	31.82	.2	.8	.13572	.9907	.13698	7.300	.2	.13572	.9907	.13698	7.300	.2	
.9	.03316	.9995	.03317	30.14	.1	.9	.13744	.9905	.13876	7.207	.1	.13744	.9905	.13876	7.207	.1	
2.0	.03490	0.9994	.03492	28.64	88.0	8.0	.13917	0.9903	.14054	7.115	82.0	.13917	0.9903	.14054	7.115	82.0	
.1	.03664	.9993	.03667	27.27	.9	.1	.14090	.9900	.14232	7.026	.9	.14090	.9900	.14232	7.026	.9	
.2	.03839	.9993	.03842	26.03	.8	.2	.14263	.9898	.14410	6.940	.8	.14263	.9898	.14410	6.940	.8	
.3	.04013	.9992	.04016	24.90	.7	.3	.14436	.9895	.14588	6.855	.7	.14436	.9895	.14588	6.855	.7	
.4	.04188	.9991	.04191	23.86	.6	.4	.14608	.9893	.14767	6.772	.6	.14608	.9893	.14767	6.772	.6	
.5	.04362	.9990	.04366	22.90	.5	.5	.14781	.9890	.14945	6.691	.5	.14781	.9890	.14945	6.691	.5	
.6	.04536	.9990	.04541	22.02	.4	.6	.14954	.9888	.15124	6.612	.4	.14954	.9888	.15124	6.612	.4	
.7	.04711	.9989	.04716	21.20	.3	.7	.15126	.9885	.15302	6.535	.3	.15126	.9885	.15302	6.535	.3	
.8	.04885	.9989	.04891	20.45	.2	.8	.15299	.9882	.15481	6.460	.2	.15299	.9882	.15481	6.460	.2	
.9	.05059	.9987	.05066	19.74	.1	.9	.15471	.9880	.15660	6.386	.1	.15471	.9880	.15660	6.386	.1	
3.0	.05234	0.9986	.05241	19.081	87.0	9.0	.15643	0.9877	.15838	6.314	81.0	.15643	0.9877	.15838	6.314	81.0	
.1	.05408	.9985	.05416	18.464	.9	.1	.15816	.9874	.16017	6.243	.9	.15816	.9874	.16017	6.243	.9	
.2	.05582	.9984	.05591	17.886	.8	.2	.15988	.9871	.16196	6.174	.8	.15988	.9871	.16196	6.174	.8	
.3	.05756	.9983	.05766	17.343	.7	.3	.16160	.9869	.16376	6.107	.7	.16160	.9869	.16376	6.107	.7	
.4	.05931	.9982	.05941	16.832	.6	.4	.16333	.9866	.16555	6.041	.6	.16333	.9866	.16555	6.041	.6	
.5	.06105	.9981	.06116	16.350	.5	.5	.16505	.9863	.16734	5.976	.5	.16505	.9863	.16734	5.976	.5	
.6	.06279	.9980	.06291	15.895	.4	.6	.16677	.9860	.16914	5.912	.4	.16677	.9860	.16914	5.912	.4	
.7	.06453	.9979	.06467	15.464	.3	.7	.16849	.9857	.17093	5.850	.3	.16849	.9857	.17093	5.850	.3	
.8	.06627	.9978	.06642	15.056	.2	.8	.17021	.9854	.17273	5.789	.2	.17021	.9854	.17273	5.789	.2	
.9	.06802	.9977	.06817	14.669	.1	.9	.17193	.9851	.17453	5.730	.1	.17193	.9851	.17453	5.730	.1	
4.0	.06976	0.9976	.06993	14.301	86.0	10.0	.1736	0.9848	.1763	5.671	80.0	.1736	0.9848	.1763	5.671	80.0	
.1	.07150	.9974	.07168	13.951	.9	.1	.1754	.9845	.1781	5.614	.9	.1754	.9845	.1781	5.614	.9	
.2	.07324	.9973	.07344	13.617	.8	.2	.1771	.9842	.1799	5.558	.8	.1771	.9842	.1799	5.558	.8	
.3	.07498	.9972	.07519	13.300	.7	.3	.1788	.9839	.1817	5.503	.7	.1788	.9839	.1817	5.503	.7	
.4	.07672	.9971	.07695	12.996	.6	.4	.1805	.9836	.1835	5.449	.6	.1805	.9836	.1835	5.449	.6	
.5	.07846	.9969	.07870	12.706	.5	.5	.1822	.9833	.1853	5.396	.5	.1822	.9833	.1853	5.396	.5	
.6	.08020	.9968	.08046	12.429	.4	.6	.1840	.9829	.1871	5.343	.4	.1840	.9829	.1871	5.343	.4	
.7	.08194	.9966	.08221	12.163	.3	.7	.1857	.9826	.1890	5.292	.3	.1857	.9826	.1890	5.292	.3	
.8	.08368	.9965	.08397	11.909	.2	.8	.1874	.9823	.1908	5.242	.2	.1874	.9823	.1908	5.242	.2	
.9	.08542	.9963	.08573	11.664	.1	.9	.1891	.9820	.1926	5.193	.1	.1891	.9820	.1926	5.193	.1	
5.0	.08716	0.9962	.08749	11.430	85.0	11.0	.1908	0.9816	.1944	5.145	79.0	.1908	0.9816	.1944	5.145	79.0	
.1	.08889	.9960	.08925	11.205	.9	.1	.1925	.9813	.1962	5.097	.9	.1925	.9813	.1962	5.097	.9	
.2	.09063	.9959	.09101	10.988	.8	.2	.1942	.9810	.1980	5.050	.8	.1942	.9810	.1980	5.050	.8	
.3	.09237	.9957	.09277	10.780	.7	.3	.1959	.9806	.1998	5.005	.7	.1959	.9806	.1998	5.005	.7	
.4	.09411	.9956	.09453	10.579	.6	.4	.1977	.9803	.2016	4.959	.6	.1977	.9803	.2016	4.959	.6	
.5	.09585	.9954	.09629	10.385	.5	.5	.1994	.9799	.2035	4.915	.5	.1994	.9799	.2035	4.915	.5	
.6	.09758	.9952	.09805	10.199	.4	.6	.2011	.9796	.2053	4.872	.4	.2011	.9796	.2053	4.872	.4	
.7	.09932	.9951	.09981	10.019	.3	.7	.2028	.9792	.2071	4.829	.3	.2028	.9792	.2071	4.829	.3	
.8	.10106	.9949	.10158	9.845	.2	.8	.2045	.9789	.2089	4.787	.2	.2045	.9789	.2089	4.787	.2	
.9	.10279	.9947	.10334	9.677	.1	.9	.2062	.9785	.2107	4.745	.1	.2062	.9785	.2107	4.745	.1	
6.0	.10453	0.9945	.10510	9.514	84.0	12.0	.2079	0.9781	.2126	4.705	78.0	.2079	0.9781	.2126	4.705	78.0	
	cos	sin	cot	tan	deg		cos	sin	cot	tan	deg		cos	sin	cot	tan	deg

Natural trigonometric functions

for decimal fractions of a degree *continued*

deg	sin	cos	tan	cot	deg	sin	cos	tan	cot	deg	sin	cos	tan	cot
12.0	0.2079	0.9781	0.2126	4.705	78.0	18.0	0.3090	0.9511	0.3249	3.078	72.0	0.3090	0.9511	0.3249
.1	.2096	.9778	.2144	4.665	.9	.1	.3107	.9505	.3269	3.060	.9	.3107	.9505	.3269
.2	.2113	.9774	.2162	4.625	.8	.2	.3123	.9500	.3288	3.042	.8	.3123	.9500	.3288
.3	.2130	.9770	.2180	4.586	.7	.3	.3140	.9494	.3307	3.024	.7	.3140	.9494	.3307
.4	.2147	.9767	.2199	4.548	.6	.4	.3156	.9489	.3327	3.006	.6	.3156	.9489	.3327
.5	.2164	.9763	.2217	4.511	.5	.5	.3173	.9483	.3346	2.989	.5	.3173	.9483	.3346
.6	.2181	.9759	.2235	4.474	.4	.6	.3190	.9478	.3365	2.971	.4	.3190	.9478	.3365
.7	.2198	.9755	.2254	4.437	.3	.7	.3206	.9472	.3385	2.954	.3	.3206	.9472	.3385
.8	.2215	.9751	.2272	4.402	.2	.8	.3223	.9466	.3404	2.937	.2	.3223	.9466	.3404
.9	.2233	.9748	.2290	4.366	.1	.9	.3239	.9461	.3424	2.921	.1	.3239	.9461	.3424
13.0	0.2250	0.9744	0.2309	4.331	77.0	19.0	0.3256	0.9455	0.3443	2.904	71.0	0.3256	0.9455	0.3443
.1	.2267	.9740	.2327	4.297	.9	.1	.3272	.9449	.3463	2.888	.9	.3272	.9449	.3463
.2	.2284	.9736	.2345	4.264	.8	.2	.3289	.9444	.3482	2.872	.8	.3289	.9444	.3482
.3	.2300	.9732	.2364	4.230	.7	.3	.3305	.9438	.3502	2.856	.7	.3305	.9438	.3502
.4	.2317	.9728	.2382	4.198	.6	.4	.3322	.9432	.3522	2.840	.6	.3322	.9432	.3522
.5	.2334	.9724	.2401	4.165	.5	.5	.3338	.9426	.3541	2.824	.5	.3338	.9426	.3541
.6	.2351	.9720	.2419	4.134	.4	.6	.3355	.9421	.3561	2.808	.4	.3355	.9421	.3561
.7	.2368	.9715	.2438	4.102	.3	.7	.3371	.9415	.3581	2.793	.3	.3371	.9415	.3581
.8	.2385	.9711	.2456	4.071	.2	.8	.3387	.9409	.3600	2.778	.2	.3387	.9409	.3600
.9	.2402	.9707	.2475	4.041	.1	.9	.3404	.9403	.3620	2.762	.1	.3404	.9403	.3620
14.0	0.2419	0.9703	0.2493	4.011	76.0	20.0	0.3420	0.9397	0.3640	2.747	70.0	0.3420	0.9397	0.3640
.1	.2436	.9699	.2512	3.981	.9	.1	.3437	.9391	.3659	2.733	.9	.3437	.9391	.3659
.2	.2453	.9694	.2530	3.952	.8	.2	.3453	.9385	.3679	2.718	.8	.3453	.9385	.3679
.3	.2470	.9690	.2549	3.923	.7	.3	.3469	.9379	.3699	2.703	.7	.3469	.9379	.3699
.4	.2487	.9686	.2568	3.895	.6	.4	.3486	.9373	.3719	2.689	.6	.3486	.9373	.3719
.5	.2504	.9681	.2586	3.867	.5	.5	.3502	.9367	.3739	2.675	.5	.3502	.9367	.3739
.6	.2521	.9677	.2605	3.839	.4	.6	.3518	.9361	.3759	2.660	.4	.3518	.9361	.3759
.7	.2538	.9673	.2623	3.812	.3	.7	.3535	.9354	.3779	2.646	.3	.3535	.9354	.3779
.8	.2554	.9668	.2642	3.785	.2	.8	.3551	.9348	.3799	2.633	.2	.3551	.9348	.3799
.9	.2571	.9664	.2661	3.758	.1	.9	.3567	.9342	.3819	2.619	.1	.3567	.9342	.3819
15.0	0.2588	0.9659	0.2679	3.732	75.0	21.0	0.3584	0.9336	0.3839	2.605	69.0	0.3584	0.9336	0.3839
.1	.2605	.9655	.2698	3.706	.9	.1	.3600	.9330	.3859	2.592	.9	.3600	.9330	.3859
.2	.2622	.9650	.2717	3.681	.8	.2	.3616	.9323	.3879	2.578	.8	.3616	.9323	.3879
.3	.2639	.9646	.2736	3.655	.7	.3	.3633	.9317	.3899	2.565	.7	.3633	.9317	.3899
.4	.2656	.9641	.2754	3.630	.6	.4	.3649	.9311	.3919	2.552	.6	.3649	.9311	.3919
.5	.2672	.9636	.2773	3.606	.5	.5	.3665	.9304	.3939	2.539	.5	.3665	.9304	.3939
.6	.2689	.9632	.2792	3.582	.4	.6	.3681	.9298	.3959	2.526	.4	.3681	.9298	.3959
.7	.2706	.9627	.2811	3.558	.3	.7	.3697	.9291	.3979	2.513	.3	.3697	.9291	.3979
.8	.2723	.9622	.2830	3.534	.2	.8	.3714	.9285	.4000	2.500	.2	.3714	.9285	.4000
.9	.2740	.9617	.2849	3.511	.1	.9	.3730	.9278	.4020	2.488	.1	.3730	.9278	.4020
16.0	0.2756	0.9613	0.2867	3.487	74.0	22.0	0.3746	0.9272	0.4040	2.475	68.0	0.3746	0.9272	0.4040
.1	.2773	.9608	.2886	3.465	.9	.1	.3762	.9265	.4061	2.463	.9	.3762	.9265	.4061
.2	.2790	.9603	.2905	3.442	.8	.2	.3778	.9259	.4081	2.450	.8	.3778	.9259	.4081
.3	.2807	.9598	.2924	3.420	.7	.3	.3795	.9252	.4101	2.438	.7	.3795	.9252	.4101
.4	.2823	.9593	.2943	3.398	.6	.4	.3811	.9245	.4122	2.426	.6	.3811	.9245	.4122
.5	.2840	.9588	.2962	3.376	.5	.5	.3827	.9239	.4142	2.414	.5	.3827	.9239	.4142
.6	.2857	.9583	.2981	3.354	.4	.6	.3843	.9232	.4163	2.402	.4	.3843	.9232	.4163
.7	.2874	.9578	.3000	3.333	.3	.7	.3859	.9225	.4183	2.391	.3	.3859	.9225	.4183
.8	.2890	.9573	.3019	3.312	.2	.8	.3875	.9219	.4204	2.379	.2	.3875	.9219	.4204
.9	.2907	.9568	.3038	3.291	.1	.9	.3891	.9212	.4224	2.367	.1	.3891	.9212	.4224
17.0	0.2924	0.9563	0.3057	3.271	73.0	23.0	0.3907	0.9205	0.4245	2.356	67.0	0.3907	0.9205	0.4245
.1	.2940	.9558	.3076	3.251	.9	.1	.3923	.9198	.4265	2.344	.9	.3923	.9198	.4265
.2	.2957	.9553	.3096	3.230	.8	.2	.3939	.9191	.4286	2.333	.8	.3939	.9191	.4286
.3	.2974	.9548	.3115	3.211	.7	.3	.3955	.9184	.4307	2.322	.7	.3955	.9184	.4307
.4	.2990	.9542	.3134	3.191	.6	.4	.3971	.9178	.4327	2.311	.6	.3971	.9178	.4327
.5	.3007	.9537	.3153	3.172	.5	.5	.3987	.9171	.4348	2.300	.5	.3987	.9171	.4348
.6	.3024	.9532	.3172	3.152	.4	.6	.4003	.9164	.4369	2.289	.4	.4003	.9164	.4369
.7	.3040	.9527	.3191	3.133	.3	.7	.4019	.9157	.4390	2.278	.3	.4019	.9157	.4390
.8	.3057	.9521	.3211	3.115	.2	.8	.4035	.9150	.4411	2.267	.2	.4035	.9150	.4411
.9	.3074	.9516	.3230	3.096	.1	.9	.4051	.9143	.4431	2.257	.1	.4051	.9143	.4431
18.0	0.3090	0.9511	0.3249	3.078	72.0	24.0	0.4067	0.9135	0.4452	2.246	66.0	0.4067	0.9135	0.4452

cos sin cot tan deg | cos sin cot tan deg

Natural trigonometric functions

for decimal fractions of a degree *continued*

deg	sin	cos	tan	cot	deg	sin	cos	tan	cot	deg	sin	cos	tan	cot
24.0	0.4067	0.9135	0.4452	2.246	66.0	0.5000	0.8660	0.5774	1.7321	60.0				
.1	.4083	.9128	.4473	2.236	.9	.5015	.8652	.5797	1.7251	.9				
.2	.4099	.9121	.4494	2.225	.8	.5030	.8643	.5820	1.7182	.8				
.3	.4115	.9114	.4515	2.215	.7	.5045	.8634	.5844	1.7113	.7				
.4	.4131	.9107	.4536	2.204	.6	.5060	.8625	.5867	1.7045	.6				
.5	.4147	.9100	.4557	2.194	.5	.5075	.8616	.5890	1.6977	.5				
.6	.4163	.9092	.4578	2.184	.4	.5090	.8607	.5914	1.6909	.4				
.7	.4179	.9085	.4599	2.174	.3	.5105	.8599	.5938	1.6842	.3				
.8	.4195	.9078	.4621	2.164	.2	.5120	.8590	.5961	1.6775	.2				
.9	.4210	.9070	.4642	2.154	.1	.5135	.8581	.5985	1.6709	.1				
25.0	0.4226	0.9063	0.4663	2.145	65.0	0.5150	0.8572	0.6009	1.6643	59.0				
.1	.4242	.9056	.4684	2.135	.9	.5165	.8563	.6032	1.6577	.9				
.2	.4258	.9048	.4706	2.125	.8	.5180	.8554	.6056	1.6512	.8				
.3	.4274	.9041	.4727	2.116	.7	.5195	.8545	.6080	1.6447	.7				
.4	.4289	.9033	.4748	2.106	.6	.5210	.8536	.6104	1.6383	.6				
.5	.4305	.9026	.4770	2.097	.5	.5225	.8526	.6128	1.6319	.5				
.6	.4321	.9018	.4791	2.087	.4	.5240	.8517	.6152	1.6255	.4				
.7	.4337	.9011	.4813	2.078	.3	.5255	.8508	.6176	1.6191	.3				
.8	.4352	.9003	.4834	2.069	.2	.5270	.8499	.6200	1.6128	.2				
.9	.4368	.8996	.4856	2.059	.1	.5284	.8490	.6224	1.6066	.1				
26.0	0.4384	0.8988	0.4877	2.050	64.0	0.5299	0.8480	0.6249	1.6003	58.0				
.1	.4399	.8980	.4899	2.041	.9	.5314	.8471	.6273	1.5941	.9				
.2	.4415	.8973	.4921	2.032	.8	.5329	.8462	.6297	1.5880	.8				
.3	.4431	.8965	.4942	2.023	.7	.5344	.8453	.6322	1.5818	.7				
.4	.4446	.8957	.4964	2.014	.6	.5358	.8443	.6346	1.5757	.6				
.5	.4462	.8949	.4986	2.006	.5	.5373	.8434	.6371	1.5697	.5				
.6	.4478	.8942	.5008	1.997	.4	.5388	.8425	.6395	1.5637	.4				
.7	.4493	.8934	.5029	1.988	.3	.5402	.8415	.6420	1.5577	.3				
.8	.4509	.8926	.5051	1.980	.2	.5417	.8406	.6445	1.5517	.2				
.9	.4524	.8918	.5073	1.971	.1	.5432	.8396	.6469	1.5458	.1				
27.0	0.4540	0.8910	0.5095	1.963	63.0	0.5446	0.8387	0.6494	1.5399	57.0				
.1	.4555	.8902	.5117	1.954	.9	.5461	.8377	.6519	1.5340	.9				
.2	.4571	.8894	.5139	1.946	.8	.5476	.8368	.6544	1.5282	.8				
.3	.4586	.8886	.5161	1.937	.7	.5490	.8358	.6569	1.5224	.7				
.4	.4602	.8878	.5184	1.929	.6	.5505	.8348	.6594	1.5166	.6				
.5	.4617	.8870	.5206	1.921	.5	.5519	.8339	.6619	1.5108	.5				
.6	.4633	.8862	.5228	1.913	.4	.5534	.8329	.6644	1.5051	.4				
.7	.4648	.8854	.5250	1.905	.3	.5548	.8320	.6669	1.4994	.3				
.8	.4664	.8846	.5272	1.897	.2	.5563	.8310	.6694	1.4938	.2				
.9	.4679	.8838	.5295	1.889	.1	.5577	.8300	.6720	1.4882	.1				
28.0	0.4695	0.8829	0.5317	1.881	62.0	0.5592	0.8290	0.6745	1.4826	56.0				
.1	.4710	.8821	.5340	1.873	.9	.5606	.8281	.6771	1.4770	.9				
.2	.4726	.8813	.5362	1.865	.8	.5621	.8271	.6796	1.4715	.8				
.3	.4741	.8805	.5384	1.857	.7	.5635	.8261	.6822	1.4659	.7				
.4	.4756	.8796	.5407	1.849	.6	.5650	.8251	.6847	1.4605	.6				
.5	.4772	.8788	.5430	1.842	.5	.5664	.8241	.6873	1.4550	.5				
.6	.4787	.8780	.5452	1.834	.4	.5678	.8231	.6899	1.4496	.4				
.7	.4802	.8771	.5475	1.827	.3	.5693	.8221	.6924	1.4442	.3				
.8	.4818	.8763	.5498	1.819	.2	.5707	.8211	.6950	1.4388	.2				
.9	.4833	.8755	.5520	1.811	.1	.5721	.8202	.6976	1.4335	.1				
29.0	0.4848	0.8746	0.5543	1.804	61.0	0.5736	0.8192	0.7002	1.4281	55.0				
.1	.4863	.8738	.5566	1.797	.9	.5750	.8181	.7028	1.4229	.9				
.2	.4879	.8729	.5589	1.789	.8	.5764	.8171	.7054	1.4176	.8				
.3	.4894	.8721	.5612	1.782	.7	.5779	.8161	.7080	1.4124	.7				
.4	.4909	.8712	.5635	1.775	.6	.5793	.8151	.7107	1.4071	.6				
.5	.4924	.8704	.5658	1.767	.5	.5807	.8141	.7133	1.4019	.5				
.6	.4939	.8695	.5681	1.760	.4	.5821	.8131	.7159	1.3968	.4				
.7	.4955	.8686	.5704	1.753	.3	.5835	.8121	.7186	1.3916	.3				
.8	.4970	.8678	.5727	1.746	.2	.5850	.8111	.7212	1.3865	.2				
.9	.4985	.8669	.5750	1.739	.1	.5864	.8100	.7239	1.3814	.1				
30.0	0.5000	0.8660	0.5774	1.732	60.0	0.5878	0.8090	0.7265	1.3764	54.0				
	cos	sin	cot	tan	deg		cos	sin	cot	tan	deg			

Natural trigonometric functions

for decimal fractions of a degree *continued*

deg	sin	cos	tan	cot	deg	sin	cos	tan	cot	deg	sin	cos	tan	cot
36.0	0.5878	0.8090	0.7265	1.3764	54.0	40.5	0.6494	0.7604	0.8541	1.1708	49.5			
.1	.5892	.8080	.7292	1.3713	.9	.6	.6508	.7593	.8571	1.1667	.4			
.2	.5906	.8070	.7319	1.3663	.8	.7	.6521	.7581	.8601	1.1626	.3			
.3	.5920	.8059	.7346	1.3613	.7	.8	.6534	.7570	.8632	1.1585	.2			
.4	.5934	.8049	.7373	1.3564	.6	.9	.6547	.7559	.8662	1.1544	.1			
.5	.5948	.8039	.7400	1.3514	.5	41.0	0.6561	0.7547	0.8693	1.1504	49.0			
.6	.5962	.8028	.7427	1.3465	.4	.1	.6574	.7536	.8724	1.1463	.9			
.7	.5976	.8018	.7454	1.3416	.3	.2	.6587	.7524	.8754	1.1423	.8			
.8	.5990	.8007	.7481	1.3367	.2	.3	.6600	.7513	.8785	1.1383	.7			
.9	.6004	.7997	.7508	1.3319	.1	.4	.6613	.7501	.8816	1.1343	.6			
37.0	0.6018	0.7986	0.7536	1.3270	53.0	.5	.6626	.7490	.8847	1.1303	.5			
.1	.6032	.7976	.7563	1.3222	.9	.6	.6639	.7478	.8878	1.1263	.4			
.2	.6046	.7965	.7590	1.3175	.8	.7	.6652	.7466	.8910	1.1224	.3			
.3	.6060	.7955	.7618	1.3127	.7	.8	.6665	.7455	.8941	1.1184	.2			
.4	.6074	.7944	.7646	1.3079	.6	.9	.6678	.7443	.8972	1.1145	.1			
.5	.6088	.7934	.7673	1.3032	.5	42.0	0.6691	0.7431	0.9004	1.1106	48.0			
.6	.6101	.7923	.7701	1.2985	.4	.1	.6704	.7420	.9036	1.1067	.9			
.7	.6115	.7912	.7729	1.2938	.3	.2	.6717	.7408	.9067	1.1028	.8			
.8	.6129	.7902	.7757	1.2892	.2	.3	.6730	.7396	.9099	1.0990	.7			
.9	.6143	.7891	.7785	1.2846	.1	.4	.6743	.7385	.9131	1.0951	.6			
38.0	0.6157	0.7880	0.7813	1.2799	52.0	.5	.6756	.7373	.9163	1.0913	.5			
.1	.6170	.7869	.7841	1.2753	.9	.6	.6769	.7361	.9195	1.0875	.4			
.2	.6184	.7859	.7869	1.2708	.8	.7	.6782	.7349	.9228	1.0837	.3			
.3	.6198	.7848	.7898	1.2662	.7	.8	.6794	.7337	.9260	1.0799	.2			
.4	.6211	.7837	.7926	1.2617	.6	.9	.6807	.7325	.9293	1.0761	.1			
.5	.6225	.7826	.7954	1.2572	.5	43.0	0.6820	0.7314	0.9325	1.0724	47.0			
.6	.6239	.7815	.7983	1.2527	.4	.1	.6833	.7302	.9358	1.0686	.9			
.7	.6252	.7804	.8012	1.2482	.3	.2	.6845	.7290	.9391	1.0649	.8			
.8	.6266	.7793	.8040	1.2437	.2	.3	.6858	.7278	.9424	1.0612	.7			
.9	.6280	.7782	.8069	1.2393	.1	.4	.6871	.7266	.9457	1.0575	.6			
39.0	0.6293	0.7771	0.8098	1.2349	51.0	.5	.6884	.7254	.9490	1.0538	.5			
.1	.6307	.7760	.8127	1.2305	.9	.6	.6896	.7242	.9523	1.0501	.4			
.2	.6320	.7749	.8156	1.2261	.8	.7	.6909	.7230	.9556	1.0464	.3			
.3	.6334	.7738	.8185	1.2218	.7	.8	.6921	.7218	.9590	1.0428	.2			
.4	.6347	.7727	.8214	1.2174	.6	.9	.6934	.7206	.9623	1.0392	.1			
.5	.6361	.7716	.8243	1.2131	.5	44.0	0.6947	0.7193	0.9657	1.0355	46.0			
.6	.6374	.7705	.8273	1.2088	.4	.1	.6959	.7181	.9691	1.0319	.9			
.7	.6388	.7694	.8302	1.2045	.3	.2	.6972	.7169	.9725	1.0283	.8			
.8	.6401	.7683	.8332	1.2002	.2	.3	.6984	.7157	.9759	1.0247	.7			
.9	.6414	.7672	.8361	1.1960	.1	.4	.6997	.7145	.9793	1.0212	.6			
40.0	0.6428	0.7660	0.8391	1.1918	50.0	.5	.7009	.7133	.9827	1.0176	.5			
.1	.6441	.7649	.8421	1.1875	.9	.6	.7022	.7120	.9861	1.0141	.4			
.2	.6455	.7638	.8451	1.1833	.8	.7	.7034	.7108	.9896	1.0105	.3			
.3	.6468	.7627	.8481	1.1792	.7	.8	.7046	.7096	.9930	1.0070	.2			
.4	.6481	.7615	.8511	1.1750	.6	.9	.7059	.7083	.9965	1.0035	.1			
40.5	0.6494	0.7604	0.8541	1.1708	49.5	45.0	0.7071	0.7071	1.0000	1.0000	45.0			
	cos	sin	cot	tan	deg		cos	sin	cot	tan	deg			

Logarithms of trigonometric functions

for decimal fractions of a degree

deg	L sin	L cos	L tan	L cot	deg	L sin	L cos	L tan	L cot	deg	L sin	L cos	L tan	L cot
0.0	—∞	0.0000	—∞	∞	90.0	6.0	9.0192	9.9976	9.0216	0.9784	84.0	9.9784	9.0216	0.9784
.1	7.2419	0.0000	7.2419	2.7581	.9	.1	9.0264	9.9975	9.0289	0.9711	.9	9.9711	9.0289	0.9711
.2	7.5429	0.0000	7.5429	2.4571	.8	.2	9.0334	9.9975	9.0360	0.9640	.8	9.9640	9.0360	0.9640
.3	7.7190	0.0000	7.7190	2.2810	.7	.3	9.0403	9.9974	9.0430	0.9570	.7	9.9570	9.0430	0.9570
.4	7.8439	0.0000	7.8439	2.1561	.6	.4	9.0472	9.9973	9.0499	0.9501	.6	9.9501	9.0499	0.9501
.5	7.9408	0.0000	7.9409	2.0591	.5	.5	9.0539	9.9972	9.0567	0.9433	.5	9.9433	9.0567	0.9433
.6	8.0200	0.0000	8.0200	1.9800	.4	.6	9.0605	9.9971	9.0633	0.9367	.4	9.9367	9.0633	0.9367
.7	8.0870	0.0000	8.0870	1.9130	.3	.7	9.0670	9.9970	9.0699	0.9301	.3	9.9301	9.0699	0.9301
.8	8.1450	0.0000	8.1450	1.8550	.2	.8	9.0734	9.9969	9.0764	0.9236	.2	9.9236	9.0764	0.9236
.9	8.1961	9.9999	8.1962	1.8038	.1	.9	9.0797	9.9968	9.0828	0.9172	.1	9.9172	9.0828	0.9172
1.0	8.2419	9.9999	8.2419	1.7581	89.0	7.0	9.0859	9.9968	9.0891	0.9109	83.0	9.9109	9.0891	0.9109
.1	8.2832	9.9999	8.2833	1.7167	.9	.1	9.0920	9.9967	9.0954	0.9046	.9	9.9046	9.0954	0.9046
.2	8.3210	9.9999	8.3211	1.6789	.8	.2	9.0981	9.9966	9.1015	0.8985	.8	9.8985	9.1015	0.8985
.3	8.3558	9.9999	8.3559	1.6441	.7	.3	9.1040	9.9965	9.1076	0.8924	.7	9.8924	9.1076	0.8924
.4	8.3880	9.9999	8.3881	1.6119	.6	.4	9.1099	9.9964	9.1135	0.8865	.6	9.8865	9.1135	0.8865
.5	8.4179	9.9999	8.4181	1.5819	.5	.5	9.1157	9.9963	9.1194	0.8806	.5	9.8806	9.1194	0.8806
.6	8.4459	9.9998	8.4461	1.5539	.4	.6	9.1214	9.9962	9.1252	0.8748	.4	9.8748	9.1252	0.8748
.7	8.4723	9.9998	8.4725	1.5275	.3	.7	9.1271	9.9961	9.1310	0.8690	.3	9.8690	9.1310	0.8690
.8	8.4971	9.9998	8.4973	1.5027	.2	.8	9.1326	9.9960	9.1367	0.8633	.2	9.8633	9.1367	0.8633
.9	8.5206	9.9998	8.5208	1.4792	.1	.9	9.1381	9.9959	9.1423	0.8577	.1	9.8577	9.1423	0.8577
2.0	8.5428	9.9997	8.5431	1.4569	88.0	8.0	9.1436	9.9958	9.1478	0.8522	82.0	9.9522	9.1478	0.8522
.1	8.5640	9.9997	8.5643	1.4357	.9	.1	9.1489	9.9956	9.1533	0.8467	.9	9.8467	9.1533	0.8467
.2	8.5842	9.9997	8.5845	1.4155	.8	.2	9.1542	9.9955	9.1587	0.8413	.8	9.8413	9.1587	0.8413
.3	8.6035	9.9996	8.6038	1.3962	.7	.3	9.1594	9.9954	9.1640	0.8360	.7	9.8360	9.1640	0.8360
.4	8.6220	9.9996	8.6223	1.3777	.6	.4	9.1646	9.9953	9.1693	0.8307	.6	9.8307	9.1693	0.8307
.5	8.6397	9.9996	8.6401	1.3599	.5	.5	9.1697	9.9952	9.1745	0.8255	.5	9.8255	9.1745	0.8255
.6	8.6567	9.9996	8.6571	1.3429	.4	.6	9.1747	9.9951	9.1797	0.8203	.4	9.8203	9.1797	0.8203
.7	8.6731	9.9995	8.6736	1.3264	.3	.7	9.1797	9.9950	9.1848	0.8152	.3	9.8152	9.1848	0.8152
.8	8.6889	9.9995	8.6894	1.3106	.2	.8	9.1847	9.9949	9.1898	0.8102	.2	9.8102	9.1898	0.8102
.9	8.7041	9.9994	8.7046	1.2954	.1	.9	9.1895	9.9947	9.1948	0.8052	.1	9.8052	9.1948	0.8052
3.0	8.7188	9.9994	8.7194	1.2806	87.0	9.0	9.1943	9.9946	9.1997	0.8003	81.0	9.9997	9.1997	0.8003
.1	8.7330	9.9994	8.7337	1.2663	.9	.1	9.1991	9.9945	9.2046	0.7954	.9	9.7954	9.2046	0.7954
.2	8.7468	9.9993	8.7475	1.2525	.8	.2	9.2038	9.9944	9.2094	0.7906	.8	9.7906	9.2094	0.7906
.3	8.7602	9.9993	8.7609	1.2391	.7	.3	9.2085	9.9943	9.2142	0.7858	.7	9.7858	9.2142	0.7858
.4	8.7731	9.9992	8.7739	1.2261	.6	.4	9.2131	9.9941	9.2189	0.7811	.6	9.7811	9.2189	0.7811
.5	8.7857	9.9992	8.7865	1.2135	.5	.5	9.2176	9.9940	9.2236	0.7764	.5	9.7764	9.2236	0.7764
.6	8.7979	9.9991	8.7988	1.2012	.4	.6	9.2221	9.9939	9.2282	0.7718	.4	9.7718	9.2282	0.7718
.7	8.8098	9.9991	8.8107	1.1893	.3	.7	9.2266	9.9937	9.2328	0.7672	.3	9.7672	9.2328	0.7672
.8	8.8213	9.9990	8.8223	1.1777	.2	.8	9.2310	9.9936	9.2374	0.7626	.2	9.7626	9.2374	0.7626
.9	8.8326	9.9990	8.8336	1.1664	.1	.9	9.2353	9.9935	9.2419	0.7581	.1	9.7581	9.2419	0.7581
4.0	8.8436	9.9989	8.8446	1.1554	86.0	10.0	9.2397	9.9934	9.2463	0.7537	80.0	9.9934	9.2463	0.7537
.1	8.8543	9.9989	8.8554	1.1446	.9	.1	9.2439	9.9932	9.2507	0.7493	.9	9.7493	9.2507	0.7493
.2	8.8647	9.9988	8.8659	1.1341	.8	.2	9.2482	9.9931	9.2551	0.7449	.8	9.7449	9.2551	0.7449
.3	8.8749	9.9988	8.8762	1.1238	.7	.3	9.2524	9.9929	9.2594	0.7406	.7	9.7406	9.2594	0.7406
.4	8.8849	9.9987	8.8862	1.1138	.6	.4	9.2565	9.9928	9.2637	0.7363	.6	9.7363	9.2637	0.7363
.5	8.8946	9.9987	8.8960	1.1040	.5	.5	9.2606	9.9927	9.2680	0.7320	.5	9.7320	9.2680	0.7320
.6	8.9042	9.9986	8.9056	1.0944	.4	.6	9.2647	9.9925	9.2722	0.7278	.4	9.7278	9.2722	0.7278
.7	8.9135	9.9985	8.9150	1.0850	.3	.7	9.2687	9.9924	9.2764	0.7236	.3	9.7236	9.2764	0.7236
.8	8.9226	9.9985	8.9241	1.0759	.2	.8	9.2727	9.9922	9.2805	0.7195	.2	9.7195	9.2805	0.7195
.9	8.9315	9.9984	8.9331	1.0669	.1	.9	9.2767	9.9921	9.2846	0.7154	.1	9.7154	9.2846	0.7154
5.0	8.9403	9.9983	8.9420	1.0580	85.0	11.0	9.2806	9.9919	9.2887	0.7113	79.0	9.9919	9.2887	0.7113
.1	8.9489	9.9983	8.9506	1.0494	.9	.1	9.2845	9.9918	9.2927	0.7073	.9	9.7073	9.2927	0.7073
.2	8.9573	9.9982	8.9591	1.0409	.8	.2	9.2883	9.9916	9.2967	0.7033	.8	9.7033	9.2967	0.7033
.3	8.9655	9.9981	8.9674	1.0326	.7	.3	9.2921	9.9915	9.3006	0.6994	.7	9.6994	9.3006	0.6994
.4	8.9736	9.9981	8.9756	1.0244	.6	.4	9.2959	9.9913	9.3046	0.6954	.6	9.6954	9.3046	0.6954
.5	8.9816	9.9980	8.9836	1.0164	.5	.5	9.2997	9.9912	9.3085	0.6915	.5	9.6915	9.3085	0.6915
.6	8.9894	9.9979	8.9915	1.0085	.4	.6	9.3034	9.9910	9.3123	0.6877	.4	9.6877	9.3123	0.6877
.7	8.9970	9.9978	8.9992	1.0008	.3	.7	9.3070	9.9909	9.3162	0.6838	.3	9.6838	9.3162	0.6838
.8	9.0046	9.9978	9.0068	0.9932	.2	.8	9.3107	9.9907	9.3200	0.6800	.2	9.6800	9.3200	0.6800
.9	9.0120	9.9977	9.0143	0.9857	.1	.9	9.3143	9.9906	9.3237	0.6763	.1	9.6763	9.3237	0.6763
6.0	9.0192	9.9976	9.0216	0.9784	84.0	12.0	9.3179	9.9904	9.3275	0.6725	78.0	9.9904	9.3275	0.6725

L cos L sin L cot L tan deg | L cos L sin L cot L tan deg

Logarithms of trigonometric functions

for decimal fractions of a degree *continued*

deg	L sin	L cos	L tan	L cot	deg	L sin	L cos	L tan	L cot	deg	L sin	L cos	L tan	L cot
12.0	9.3179	9.9904	9.3275	0.6725	78.0	18.0	9.4900	9.9782	9.5118	0.4882	72.0			
.1	9.3214	9.9902	9.3312	0.6688	.9	.1	9.4923	9.9780	9.5143	0.4857	.9			
.2	9.3250	9.9901	9.3349	0.6651	.8	.2	9.4946	9.9777	9.5169	0.4831	.8			
.3	9.3284	9.9899	9.3385	0.6615	.7	.3	9.4969	9.9775	9.5195	0.4805	.7			
.4	9.3319	9.9897	9.3422	0.6578	.6	.4	9.4992	9.9772	9.5220	0.4780	.6			
.5	9.3353	9.9896	9.3458	0.6542	.5	.5	9.5015	9.9770	9.5245	0.4755	.5			
.6	9.3387	9.9894	9.3493	0.6507	.4	.6	9.5037	9.9767	9.5270	0.4730	.4			
.7	9.3421	9.9892	9.3529	0.6471	.3	.7	9.5060	9.9764	9.5295	0.4705	.3			
.8	9.3455	9.9891	9.3564	0.6436	.2	.8	9.5082	9.9762	9.5320	0.4680	.2			
.9	9.3488	9.9889	9.3599	0.6401	.1	.9	9.5104	9.9759	9.5345	0.4655	.1			
13.0	9.3521	9.9887	9.3634	0.6366	77.0	19.0	9.5126	9.9757	9.5370	0.4630	71.0			
.1	9.3554	9.9885	9.3668	0.6332	.9	.1	9.5148	9.9754	9.5394	0.4606	.9			
.2	9.3586	9.9884	9.3702	0.6298	.8	.2	9.5170	9.9751	9.5419	0.4581	.8			
.3	9.3618	9.9882	9.3736	0.6264	.7	.3	9.5192	9.9749	9.5443	0.4557	.7			
.4	9.3650	9.9880	9.3770	0.6230	.6	.4	9.5213	9.9746	9.5467	0.4533	.6			
.5	9.3682	9.9878	9.3804	0.6196	.5	.5	9.5235	9.9743	9.5491	0.4509	.5			
.6	9.3713	9.9876	9.3837	0.6163	.4	.6	9.5256	9.9741	9.5516	0.4484	.4			
.7	9.3745	9.9875	9.3870	0.6130	.3	.7	9.5278	9.9738	9.5539	0.4461	.3			
.8	9.3775	9.9873	9.3903	0.6097	.2	.8	9.5299	9.9735	9.5563	0.4437	.2			
.9	9.3806	9.9871	9.3935	0.6065	.1	.9	9.5320	9.9733	9.5587	0.4413	.1			
14.0	9.3837	9.9869	9.3968	0.6032	76.0	20.0	9.5341	9.9730	9.5611	0.4389	70.0			
.1	9.3867	9.9867	9.4000	0.6000	.9	.1	9.5361	9.9727	9.5634	0.4366	.9			
.2	9.3897	9.9865	9.4032	0.5968	.8	.2	9.5382	9.9724	9.5658	0.4342	.8			
.3	9.3927	9.9863	9.4064	0.5936	.7	.3	9.5402	9.9722	9.5681	0.4319	.7			
.4	9.3957	9.9861	9.4095	0.5905	.6	.4	9.5423	9.9719	9.5704	0.4296	.6			
.5	9.3986	9.9859	9.4127	0.5873	.5	.5	9.5443	9.9716	9.5727	0.4273	.5			
.6	9.4015	9.9857	9.4158	0.5842	.4	.6	9.5463	9.9713	9.5750	0.4250	.4			
.7	9.4044	9.9855	9.4189	0.5811	.3	.7	9.5484	9.9710	9.5773	0.4227	.3			
.8	9.4073	9.9853	9.4220	0.5780	.2	.8	9.5504	9.9707	9.5796	0.4204	.2			
.9	9.4102	9.9851	9.4250	0.5750	.1	.9	9.5523	9.9704	9.5819	0.4181	.1			
15.0	9.4130	9.9849	9.4281	0.5719	75.0	21.0	9.5543	9.9702	9.5842	0.4158	69.0			
.1	9.4158	9.9847	9.4311	0.5689	.9	.1	9.5563	9.9699	9.5864	0.4136	.9			
.2	9.4186	9.9845	9.4341	0.5659	.8	.2	9.5583	9.9696	9.5887	0.4113	.8			
.3	9.4214	9.9843	9.4371	0.5629	.7	.3	9.5602	9.9693	9.5909	0.4091	.7			
.4	9.4242	9.9841	9.4400	0.5600	.6	.4	9.5621	9.9690	9.5932	0.4068	.6			
.5	9.4269	9.9839	9.4430	0.5570	.5	.5	9.5641	9.9687	9.5954	0.4046	.5			
.6	9.4296	9.9837	9.4459	0.5541	.4	.6	9.5660	9.9684	9.5976	0.4024	.4			
.7	9.4323	9.9835	9.4488	0.5512	.3	.7	9.5679	9.9681	9.5998	0.4002	.3			
.8	9.4350	9.9833	9.4517	0.5483	.2	.8	9.5698	9.9678	9.6020	0.3980	.2			
.9	9.4377	9.9831	9.4546	0.5454	.1	.9	9.5717	9.9675	9.6042	0.3958	.1			
16.0	9.4403	9.9828	9.4575	0.5425	74.0	22.0	9.5736	9.9672	9.6064	0.3936	68.0			
.1	9.4430	9.9826	9.4603	0.5397	.9	.1	9.5754	9.9669	9.6086	0.3914	.9			
.2	9.4456	9.9824	9.4632	0.5368	.8	.2	9.5773	9.9666	9.6108	0.3892	.8			
.3	9.4482	9.9822	9.4660	0.5340	.7	.3	9.5792	9.9662	9.6129	0.3871	.7			
.4	9.4508	9.9820	9.4688	0.5312	.6	.4	9.5810	9.9659	9.6151	0.3849	.6			
.5	9.4533	9.9817	9.4716	0.5284	.5	.5	9.5828	9.9656	9.6172	0.3828	.5			
.6	9.4559	9.9815	9.4744	0.5256	.4	.6	9.5847	9.9653	9.6194	0.3806	.4			
.7	9.4584	9.9813	9.4771	0.5229	.3	.7	9.5865	9.9650	9.6215	0.3785	.3			
.8	9.4609	9.9811	9.4799	0.5201	.2	.8	9.5883	9.9647	9.6236	0.3764	.2			
.9	9.4634	9.9808	9.4826	0.5174	.1	.9	9.5901	9.9643	9.6257	0.3743	.1			
17.0	9.4659	9.9806	9.4853	0.5147	73.0	23.0	9.5919	9.9640	9.6279	0.3721	67.0			
.1	9.4684	9.9804	9.4880	0.5120	.9	.1	9.5937	9.9637	9.6300	0.3700	.9			
.2	9.4709	9.9801	9.4907	0.5093	.8	.2	9.5954	9.9634	9.6321	0.3679	.8			
.3	9.4733	9.9799	9.4934	0.5066	.7	.3	9.5972	9.9631	9.6341	0.3659	.7			
.4	9.4757	9.9797	9.4961	0.5039	.6	.4	9.5990	9.9627	9.6362	0.3638	.6			
.5	9.4781	9.9794	9.4987	0.5013	.5	.5	9.6007	9.9624	9.6383	0.3617	.5			
.6	9.4805	9.9792	9.5014	0.4986	.4	.6	9.6024	9.9621	9.6404	0.3596	.4			
.7	9.4829	9.9789	9.5040	0.4960	.3	.7	9.6042	9.9617	9.6424	0.3576	.3			
.8	9.4853	9.9787	9.5066	0.4934	.2	.8	9.6059	9.9614	9.6445	0.3555	.2			
.9	9.4876	9.9785	9.5092	0.4908	.1	.9	9.6076	9.9611	9.6465	0.3535	.1			
18.0	9.4900	9.9782	9.5118	0.4882	72.0	24.0	9.6093	9.9607	9.6486	0.3514	66.0			

L cos L sin L cot L tan deg L cos L sin L cot L tan deg

Logarithms of trigonometric functions

for decimal fractions of a degree *continued*

deg	L sin	L cos	L tan	L cot		deg	L sin	L cos	L tan	L cot		deg	L sin	L cos	L tan	L cot
24.0	9.6093	9.9607	9.6486	0.3514		66.0	9.6990	9.9375	9.7614	0.2386		60.0	9.6990	9.9375	9.7614	0.2386
.1	9.6110	9.9604	9.6506	0.3494		.9	9.7003	9.9371	9.7632	0.2368		.9	9.7003	9.9371	9.7632	0.2368
.2	9.6127	9.9601	9.6527	0.3473		.8	9.7016	9.9367	9.7649	0.2351		.8	9.7016	9.9367	9.7649	0.2351
.3	9.6144	9.9597	9.6547	0.3453		.7	9.7029	9.9362	9.7667	0.2333		.7	9.7029	9.9362	9.7667	0.2333
.4	9.6161	9.9594	9.6567	0.3433		.6	9.7042	9.9358	9.7684	0.2316		.6	9.7042	9.9358	9.7684	0.2316
.5	9.6177	9.9590	9.6587	0.3413		.5	9.7055	9.9353	9.7701	0.2299		.5	9.7055	9.9353	9.7701	0.2299
.6	9.6194	9.9587	9.6607	0.3393		.4	9.7068	9.9349	9.7719	0.2281		.4	9.7068	9.9349	9.7719	0.2281
.7	9.6210	9.9583	9.6627	0.3373		.3	9.7080	9.9344	9.7736	0.2264		.3	9.7080	9.9344	9.7736	0.2264
.8	9.6227	9.9580	9.6647	0.3353		.2	9.7093	9.9340	9.7753	0.2247		.2	9.7093	9.9340	9.7753	0.2247
.9	9.6243	9.9576	9.6667	0.3333		.1	9.7106	9.9335	9.7771	0.2229		.1	9.7106	9.9335	9.7771	0.2229
25.0	9.6259	9.9573	9.6687	0.3313		65.0	9.7118	9.9331	9.7788	0.2212		59.0	9.7118	9.9331	9.7788	0.2212
.1	9.6276	9.9569	9.6707	0.3294		.9	9.7131	9.9326	9.7805	0.2195		.9	9.7131	9.9326	9.7805	0.2195
.2	9.6292	9.9566	9.6726	0.3274		.8	9.7144	9.9322	9.7822	0.2178		.8	9.7144	9.9322	9.7822	0.2178
.3	9.6308	9.9562	9.6746	0.3254		.7	9.7156	9.9317	9.7839	0.2161		.7	9.7156	9.9317	9.7839	0.2161
.4	9.6324	9.9558	9.6765	0.3235		.6	9.7168	9.9312	9.7856	0.2144		.6	9.7168	9.9312	9.7856	0.2144
.5	9.6340	9.9555	9.6785	0.3215		.5	9.7181	9.9308	9.7873	0.2127		.5	9.7181	9.9308	9.7873	0.2127
.6	9.6356	9.9551	9.6804	0.3196		.4	9.7193	9.9303	9.7890	0.2110		.4	9.7193	9.9303	9.7890	0.2110
.7	9.6371	9.9548	9.6824	0.3176		.3	9.7205	9.9298	9.7907	0.2093		.3	9.7205	9.9298	9.7907	0.2093
.8	9.6387	9.9544	9.6843	0.3157		.2	9.7218	9.9294	9.7924	0.2076		.2	9.7218	9.9294	9.7924	0.2076
.9	9.6403	9.9540	9.6863	0.3137		.1	9.7230	9.9289	9.7941	0.2059		.1	9.7230	9.9289	9.7941	0.2059
26.0	9.6418	9.9537	9.6882	0.3118		64.0	9.7242	9.9284	9.7958	0.2042		58.0	9.7242	9.9284	9.7958	0.2042
.1	9.6434	9.9533	9.6901	0.3099		.9	9.7254	9.9279	9.7975	0.2025		.9	9.7254	9.9279	9.7975	0.2025
.2	9.6449	9.9529	9.6920	0.3080		.8	9.7266	9.9275	9.7992	0.2008		.8	9.7266	9.9275	9.7992	0.2008
.3	9.6465	9.9525	9.6939	0.3061		.7	9.7278	9.9270	9.8008	0.1992		.7	9.7278	9.9270	9.8008	0.1992
.4	9.6480	9.9522	9.6958	0.3042		.6	9.7290	9.9265	9.8025	0.1975		.6	9.7290	9.9265	9.8025	0.1975
.5	9.6495	9.9518	9.6977	0.3023		.5	9.7302	9.9260	9.8042	0.1958		.5	9.7302	9.9260	9.8042	0.1958
.6	9.6510	9.9514	9.6996	0.3004		.4	9.7314	9.9255	9.8059	0.1941		.4	9.7314	9.9255	9.8059	0.1941
.7	9.6526	9.9510	9.7015	0.2985		.3	9.7326	9.9251	9.8075	0.1925		.3	9.7326	9.9251	9.8075	0.1925
.8	9.6541	9.9506	9.7034	0.2966		.2	9.7338	9.9246	9.8092	0.1908		.2	9.7338	9.9246	9.8092	0.1908
.9	9.6556	9.9503	9.7053	0.2947		.1	9.7349	9.9241	9.8109	0.1891		.1	9.7349	9.9241	9.8109	0.1891
27.0	9.6570	9.9499	9.7072	0.2928		63.0	9.7361	9.9236	9.8125	0.1875		57.0	9.7361	9.9236	9.8125	0.1875
.1	9.6585	9.9495	9.7090	0.2910		.9	9.7373	9.9231	9.8142	0.1858		.9	9.7373	9.9231	9.8142	0.1858
.2	9.6600	9.9491	9.7109	0.2891		.8	9.7384	9.9226	9.8158	0.1842		.8	9.7384	9.9226	9.8158	0.1842
.3	9.6615	9.9487	9.7128	0.2872		.7	9.7396	9.9221	9.8175	0.1825		.7	9.7396	9.9221	9.8175	0.1825
.4	9.6629	9.9483	9.7146	0.2854		.6	9.7407	9.9216	9.8191	0.1809		.6	9.7407	9.9216	9.8191	0.1809
.5	9.6644	9.9479	9.7165	0.2835		.5	9.7419	9.9211	9.8208	0.1792		.5	9.7419	9.9211	9.8208	0.1792
.6	9.6659	9.9475	9.7183	0.2817		.4	9.7430	9.9206	9.8224	0.1776		.4	9.7430	9.9206	9.8224	0.1776
.7	9.6673	9.9471	9.7202	0.2798		.3	9.7442	9.9201	9.8241	0.1759		.3	9.7442	9.9201	9.8241	0.1759
.8	9.6687	9.9467	9.7220	0.2780		.2	9.7453	9.9196	9.8257	0.1743		.2	9.7453	9.9196	9.8257	0.1743
.9	9.6702	9.9463	9.7238	0.2762		.1	9.7464	9.9191	9.8274	0.1726		.1	9.7464	9.9191	9.8274	0.1726
28.0	9.6716	9.9459	9.7257	0.2743		62.0	9.7476	9.9186	9.8290	0.1710		56.0	9.7476	9.9186	9.8290	0.1710
.1	9.6730	9.9455	9.7275	0.2725		.9	9.7487	9.9181	9.8306	0.1694		.9	9.7487	9.9181	9.8306	0.1694
.2	9.6744	9.9451	9.7293	0.2707		.8	9.7498	9.9175	9.8323	0.1677		.8	9.7498	9.9175	9.8323	0.1677
.3	9.6759	9.9447	9.7311	0.2689		.7	9.7509	9.9170	9.8339	0.1661		.7	9.7509	9.9170	9.8339	0.1661
.4	9.6773	9.9443	9.7330	0.2670		.6	9.7520	9.9165	9.8355	0.1645		.6	9.7520	9.9165	9.8355	0.1645
.5	9.6787	9.9439	9.7348	0.2652		.5	9.7531	9.9160	9.8371	0.1629		.5	9.7531	9.9160	9.8371	0.1629
.6	9.6801	9.9435	9.7366	0.2634		.4	9.7542	9.9155	9.8388	0.1612		.4	9.7542	9.9155	9.8388	0.1612
.7	9.6814	9.9431	9.7384	0.2616		.3	9.7553	9.9149	9.8404	0.1596		.3	9.7553	9.9149	9.8404	0.1596
.8	9.6828	9.9427	9.7402	0.2598		.2	9.7564	9.9144	9.8420	0.1580		.2	9.7564	9.9144	9.8420	0.1580
.9	9.6842	9.9422	9.7420	0.2580		.1	9.7575	9.9139	9.8436	0.1564		.1	9.7575	9.9139	9.8436	0.1564
29.0	9.6856	9.9418	9.7438	0.2562		61.0	9.7586	9.9134	9.8452	0.1548		55.0	9.7586	9.9134	9.8452	0.1548
.1	9.6869	9.9414	9.7455	0.2545		.9	9.7597	9.9128	9.8468	0.1532		.9	9.7597	9.9128	9.8468	0.1532
.2	9.6883	9.9410	9.7473	0.2527		.8	9.7607	9.9123	9.8484	0.1516		.8	9.7607	9.9123	9.8484	0.1516
.3	9.6896	9.9406	9.7491	0.2509		.7	9.7618	9.9118	9.8501	0.1499		.7	9.7618	9.9118	9.8501	0.1499
.4	9.6910	9.9401	9.7509	0.2491		.6	9.7629	9.9112	9.8517	0.1483		.6	9.7629	9.9112	9.8517	0.1483
.5	9.6923	9.9397	9.7526	0.2474		.5	9.7640	9.9107	9.8533	0.1467		.5	9.7640	9.9107	9.8533	0.1467
.6	9.6937	9.9393	9.7544	0.2456		.4	9.7650	9.9101	9.8549	0.1451		.4	9.7650	9.9101	9.8549	0.1451
.7	9.6950	9.9388	9.7562	0.2438		.3	9.7661	9.9096	9.8565	0.1435		.3	9.7661	9.9096	9.8565	0.1435
.8	9.6963	9.9384	9.7579	0.2421		.2	9.7671	9.9091	9.8581	0.1419		.2	9.7671	9.9091	9.8581	0.1419
.9	9.6977	9.9380	9.7597	0.2403		.1	9.7682	9.9085	9.8597	0.1403		.1	9.7682	9.9085	9.8597	0.1403
30.0	9.6990	9.9375	9.7614	0.2386		60.0	9.7692	9.9080	9.8613	0.1387		54.0	9.7692	9.9080	9.8613	0.1387

L cos L sin L cot L tan deg | L cos L sin L cot L tan deg

Logarithms of trigonometric functions

for decimal fractions of a degree *continued*

deg	L sin	L cos	L tan	L cot		deg	L sin	L cos	L tan	L cot	
36.0	9.7692	9.9080	9.8613	0.1387	54.0	40.5	9.8125	9.8810	9.9315	0.0685	49.5
.1	9.7703	9.9074	9.8629	0.1371	.9	.6	9.8134	9.8804	9.9330	0.0670	.4
.2	9.7713	9.9069	9.8644	0.1356	.8	.7	9.8143	9.8797	9.9346	0.0654	.3
.3	9.7723	9.9063	9.8660	0.1340	.7	.8	9.8152	9.8791	9.9361	0.0639	.2
.4	9.7734	9.9057	9.8676	0.1324	.6	.9	9.8161	9.8784	9.9376	0.0624	.1
.5	9.7744	9.9052	9.8692	0.1308	.5	41.0	9.8169	9.8778	9.9392	0.0608	49.0
.6	9.7754	9.9046	9.8708	0.1292	.4	.1	9.8178	9.8771	9.9407	0.0593	.9
.7	9.7764	9.9041	9.8724	0.1276	.3	.2	9.8187	9.8765	9.9422	0.0578	.8
.8	9.7774	9.9035	9.8740	0.1260	.2	.3	9.8195	9.8758	9.9438	0.0562	.7
.9	9.7785	9.9029	9.8755	0.1245	.1	.4	9.8204	9.8751	9.9453	0.0547	.6
37.0	9.7795	9.9023	9.8771	0.1229	53.0	.5	9.8213	9.8745	9.9468	0.0532	.5
.1	9.7805	9.9018	9.8787	0.1213	.9	.6	9.8221	9.8738	9.9483	0.0517	.4
.2	9.7815	9.9012	9.8803	0.1197	.8	.7	9.8230	9.8731	9.9499	0.0501	.3
.3	9.7825	9.9006	9.8818	0.1182	.7	.8	9.8238	9.8724	9.9514	0.0486	.2
.4	9.7835	9.9000	9.8834	0.1166	.6	.9	9.8247	9.8718	9.9529	0.0471	.1
.5	9.7844	9.8995	9.8850	0.1150	.5	42.0	9.8255	9.8711	9.9544	0.0456	48.0
.6	9.7854	9.8989	9.8865	0.1135	.4	.1	9.8264	9.8704	9.9560	0.0440	.9
.7	9.7864	9.8983	9.8881	0.1119	.3	.2	9.8272	9.8697	9.9575	0.0425	.8
.8	9.7874	9.8977	9.8897	0.1103	.2	.3	9.8280	9.8690	9.9590	0.0410	.7
.9	9.7884	9.8971	9.8912	0.1088	.1	.4	9.8289	9.8683	9.9605	0.0395	.6
38.0	9.7893	9.8965	9.8928	0.1072	52.0	.5	9.8297	9.8676	9.9621	0.0379	.5
.1	9.7903	9.8959	9.8944	0.1056	.9	.6	9.8305	9.8669	9.9636	0.0364	.4
.2	9.7913	9.8953	9.8959	0.1041	.8	.7	9.8313	9.8662	9.9651	0.0349	.3
.3	9.7922	9.8947	9.8975	0.1025	.7	.8	9.8322	9.8655	9.9666	0.0334	.2
.4	9.7932	9.8941	9.8990	0.1010	.6	.9	9.8330	9.8648	9.9681	0.0319	.1
.5	9.7941	9.8935	9.9006	0.0994	.5	43.0	9.8338	9.8641	9.9697	0.0303	47.0
.6	9.7951	9.8929	9.9022	0.0978	.4	.1	9.8346	9.8634	9.9712	0.0288	.9
.7	9.7960	9.8923	9.9037	0.0963	.3	.2	9.8354	9.8627	9.9727	0.0273	.8
.8	9.7970	9.8917	9.9053	0.0947	.2	.3	9.8362	9.8620	9.9742	0.0258	.7
.9	9.7979	9.8911	9.9068	0.0932	.1	.4	9.8370	9.8613	9.9757	0.0243	.6
39.0	9.7989	9.8905	9.9084	0.0916	51.0	.5	9.8378	9.8606	9.9772	0.0228	.5
.1	9.7998	9.8899	9.9099	0.0901	.9	.6	9.8386	9.8598	9.9788	0.0212	.4
.2	9.8007	9.8893	9.9115	0.0885	.8	.7	9.8394	9.8591	9.9803	0.0197	.3
.3	9.8017	9.8887	9.9130	0.0870	.7	.8	9.8402	9.8584	9.9818	0.0182	.2
.4	9.8026	9.8880	9.9146	0.0854	.6	.9	9.8410	9.8577	9.9833	0.0167	.1
.5	9.8035	9.8874	9.9161	0.0839	.5	44.0	9.8418	9.8569	9.9848	0.0152	46.0
.6	9.8044	9.8868	9.9176	0.0824	.4	.1	9.8426	9.8562	9.9864	0.0136	.9
.7	9.8053	9.8862	9.9192	0.0808	.3	.2	9.8433	9.8555	9.9879	0.0121	.8
.8	9.8063	9.8855	9.9207	0.0793	.2	.3	9.8441	9.8547	9.9894	0.0106	.7
.9	9.8072	9.8849	9.9223	0.0777	.1	.4	9.8449	9.8540	9.9909	0.0091	.6
40.0	9.8081	9.8843	9.9238	0.0762	50.0	.5	9.8457	9.8532	9.9924	0.0076	.5
.1	9.8090	9.8836	9.9254	0.0746	.9	.6	9.8464	9.8525	9.9939	0.0061	.4
.2	9.8099	9.8830	9.9269	0.0731	.8	.7	9.8472	9.8517	9.9955	0.0045	.3
.3	9.8108	9.8823	9.9284	0.0716	.7	.8	9.8480	9.8510	9.9970	0.0030	.2
.4	9.8117	9.8817	9.9300	0.0700	.6	.9	9.8487	9.8502	9.9985	0.0015	.1
40.5	9.8125	9.8810	9.9315	0.0685	49.5	45.0	9.8495	9.8495	0.0000	0.0000	45.0

L cos L sin L cot L tan deg L cos L sin L cot L tan deg

Natural logarithms

	0	1	2	3	4	5	6	7	8	9	mean differences								
											1	2	3	4	5	6	7	8	9
1.0	0.0000	0100	0198	0296	0392	0488	0583	0677	0770	0862	10	19	29	38	48	57	67	76	86
1.1	0.0953	1044	1133	1222	1310	1398	1484	1570	1655	1740	9	17	26	35	44	52	61	70	78
1.2	0.1823	1906	1989	2070	2151	2231	2311	2390	2469	2546	8	16	24	32	40	48	56	64	72
1.3	0.2624	2700	2776	2852	2927	3001	3075	3148	3221	3293	7	15	22	30	37	44	52	59	67
1.4	0.3365	3436	3507	3577	3646	3716	3784	3853	3920	3988	7	14	21	28	35	41	48	55	62
1.5	0.4055	4121	4187	4253	4318	4383	4447	4511	4574	4637	6	13	19	26	32	39	45	52	58
1.6	0.4700	4762	4824	4886	4947	5008	5068	5128	5188	5247	6	12	18	24	30	36	42	48	55
1.7	0.5306	5365	5423	5481	5539	5596	5653	5710	5766	5822	6	11	17	23	29	34	40	46	51
1.8	0.5378	5933	5988	6043	6098	6152	6206	6259	6313	6366	5	11	16	22	27	32	38	43	49
1.9	0.6419	6471	6523	6575	6627	6678	6729	6780	6831	6881	5	10	15	20	26	31	36	41	46
2.0	0.6931	6981	7031	7080	7129	7178	7227	7275	7324	7372	5	10	15	20	24	29	34	39	44
2.1	0.7419	7467	7514	7561	7608	7655	7701	7747	7793	7839	5	9	14	19	23	28	33	37	42
2.2	0.7885	7930	7975	8020	8065	8109	8154	8198	8242	8286	4	9	13	18	22	27	31	36	40
2.3	0.8329	8372	8416	8459	8502	8544	8587	8629	8671	8713	4	9	13	17	21	26	30	34	38
2.4	0.8755	8796	8838	8879	8920	8961	9002	9042	9083	9123	4	8	12	16	20	24	29	33	37
2.5	0.9163	9203	9243	9282	9322	9361	9400	9439	9478	9517	4	8	12	16	20	24	27	31	35
2.6	0.9555	9594	9632	9670	9708	9746	9783	9821	9858	9895	4	8	11	15	19	23	26	30	34
2.7	0.9933	9969	1.0006	0.0043	0.0080	0.0116	0.0152	0.0188	0.0225	0.0260	4	7	11	15	18	22	25	29	33
2.8	1.0296	0332	0367	0403	0438	0473	0508	0543	0578	0613	4	7	11	14	18	21	25	28	32
2.9	1.0647	0682	0716	0750	0784	0818	0852	0886	0919	0953	3	7	10	14	17	20	24	27	31
3.0	1.0986	1019	1053	1086	1119	1151	1184	1217	1249	1282	3	7	10	13	16	20	23	26	30
3.1	1.1314	1346	1378	1410	1442	1474	1506	1537	1569	1600	3	6	10	13	16	19	22	25	29
3.2	1.1632	1663	1694	1725	1756	1787	1817	1848	1878	1909	3	6	9	12	15	18	22	25	28
3.3	1.1939	1969	2000	2030	2060	2090	2119	2149	2179	2208	3	6	9	12	15	18	21	24	27
3.4	1.2238	2267	2296	2326	2355	2384	2413	2442	2470	2499	3	6	9	12	15	17	20	23	26
3.5	1.2528	2556	2585	2613	2641	2669	2698	2726	2754	2782	3	6	8	11	14	17	20	23	25
3.6	1.2809	2837	2865	2892	2920	2947	2975	3002	3029	3056	3	5	8	11	14	16	19	22	25
3.7	1.3033	3110	3137	3164	3191	3218	3244	3271	3297	3324	3	5	8	11	13	16	19	21	24
3.8	1.3350	3376	3403	3429	3455	3481	3507	3533	3558	3584	3	5	8	10	13	16	18	21	23
3.9	1.3610	3635	3661	3686	3712	3737	3762	3788	3813	3838	3	5	8	10	13	15	18	20	23
4.0	1.3863	3888	3913	3938	3962	3987	4012	4036	4061	4085	2	5	7	10	12	15	17	20	22
4.1	1.4110	4134	4159	4183	4207	4231	4255	4279	4303	4327	2	5	7	10	12	14	17	19	22
4.2	1.4351	4375	4398	4422	4446	4469	4493	4516	4540	4563	2	5	7	9	12	14	16	19	21
4.3	1.4586	4609	4633	4656	4679	4702	4725	4748	4770	4793	2	5	7	9	12	14	16	18	21
4.4	1.4816	4839	4861	4884	4907	4929	4951	4974	4996	5019	2	5	7	9	11	14	16	18	20
4.5	1.5041	5063	5085	5107	5129	5151	5173	5195	5217	5239	2	4	7	9	11	13	15	18	20
4.6	1.5261	5282	5304	5326	5347	5369	5390	5412	5433	5454	2	4	6	9	11	13	15	17	19
4.7	1.5476	5497	5518	5539	5560	5581	5602	5623	5644	5665	2	4	6	8	11	13	15	17	19
4.8	1.5686	5707	5728	5748	5769	5790	5810	5831	5851	5872	2	4	6	8	10	12	14	16	19
4.9	1.5892	5913	5933	5953	5974	5994	6014	6034	6054	6074	2	4	6	8	10	12	14	16	18
5.0	1.6094	6114	6134	6154	6174	6194	6214	6233	6253	6273	2	4	6	8	10	12	14	16	18
5.1	1.6292	6312	6332	6351	6371	6390	6409	6429	6448	6467	2	4	6	8	10	12	14	16	18
5.2	1.6487	6506	6525	6544	6563	6582	6601	6620	6639	6658	2	4	6	8	10	11	13	15	17
5.3	1.6677	6696	6715	6734	6752	6771	6790	6808	6827	6845	2	4	6	7	9	11	13	15	17
5.4	1.6864	6882	6901	6919	6938	6956	6974	6993	7011	7029	2	4	5	7	9	11	13	15	17

Natural logarithms of 10⁺ⁿ

n	1	2	3	4	5	6	7	8	9
log _e 10 ⁿ	2.3026	4.6052	6.9078	9.2103	11.5129	13.8155	16.1181	18.4207	20.7233

Natural logarithms *continued*

										mean differences									
	0	1	2	3	4	5	6	7	8	9	1	2	3	4	5	6	7	8	9
5.5	1.7047	7066	7084	7102	7120	7138	7156	7174	7192	7210	2	4	5	7	9	11	13	14	16
5.6	1.7228	7246	7263	7281	7299	7317	7334	7352	7370	7387	2	4	5	7	9	11	12	14	16
5.7	1.7405	7422	7440	7457	7475	7492	7509	7527	7544	7561	2	3	5	7	9	10	12	14	16
5.8	1.7579	7596	7613	7630	7647	7664	7681	7699	7716	7733	2	3	5	7	9	10	12	14	15
5.9	1.7750	7766	7783	7800	7817	7834	7851	7867	7884	7901	2	3	5	7	8	10	12	13	15
6.0	1.7918	7934	7951	7967	7984	8001	8017	8034	8050	8066	2	3	5	7	8	10	12	13	15
6.1	1.8083	8099	8116	8132	8148	8165	8181	8197	8213	8229	2	3	5	6	8	10	11	13	15
6.2	1.8245	8262	8278	8294	8310	8326	8342	8358	8374	8390	2	3	5	6	8	10	11	13	14
6.3	1.8405	8421	8437	8453	8469	8485	8500	8516	8532	8547	2	3	5	6	8	9	11	13	14
6.4	1.8563	8579	8594	8610	8625	8641	8656	8672	8687	8703	2	3	5	6	8	9	11	12	14
6.5	1.8718	8733	8749	8764	8779	8795	8810	8825	8840	8856	2	3	5	6	8	9	11	12	14
6.6	1.8871	8886	8901	8916	8931	8946	8961	8976	8991	9006	2	3	5	6	8	9	11	12	14
6.7	1.9021	9036	9051	9066	9081	9095	9110	9125	9140	9155	1	3	4	6	7	9	10	12	13
6.8	1.9169	9184	9199	9213	9228	9242	9257	9272	9286	9301	1	3	4	6	7	9	10	12	13
6.9	1.9315	9330	9344	9359	9373	9387	9402	9416	9430	9445	1	3	4	6	7	9	10	12	13
7.0	1.9459	9473	9488	9502	9516	9530	9544	9559	9573	9587	1	3	4	6	7	9	10	11	13
7.1	1.9601	9615	9629	9643	9657	9671	9685	9699	9713	9727	1	3	4	6	7	8	10	11	13
7.2	1.9741	9755	9769	9782	9796	9810	9824	9838	9851	9865	1	3	4	6	7	8	10	11	12
7.3	1.9879	9892	9906	9920	9933	9947	9961	9974	9988	2.0001	1	3	4	5	7	8	10	11	12
7.4	2.0015	0028	0042	0055	0069	0082	0096	0109	0122	0136	1	3	4	5	7	8	9	11	12
7.5	2.0149	0162	0176	0189	0202	0215	0229	0242	0255	0268	1	3	4	5	7	8	9	11	12
7.6	2.0281	0295	0308	0321	0334	0347	0360	0373	0386	0399	1	3	4	5	7	8	9	10	12
7.7	2.0412	0425	0438	0451	0464	0477	0490	0503	0516	0528	1	3	4	5	6	8	9	10	12
7.8	2.0541	0554	0567	0580	0592	0605	0618	0631	0643	0656	1	3	4	5	6	8	9	10	11
7.9	2.0669	0681	0694	0707	0719	0732	0744	0757	0769	0782	1	3	4	5	6	8	9	10	11
8.0	2.0794	0807	0819	0832	0844	0857	0869	0882	0894	0906	1	3	4	5	6	7	9	10	11
8.1	2.0919	0931	0943	0956	0968	0980	0992	1005	1017	1029	1	2	4	5	6	7	9	10	11
8.2	2.1041	1054	1066	1078	1090	1102	1114	1126	1138	1150	1	2	4	5	6	7	9	10	11
8.3	2.1163	1175	1187	1199	1211	1223	1235	1247	1258	1270	1	2	4	5	6	7	8	10	11
8.4	2.1282	1294	1306	1318	1330	1342	1353	1365	1377	1389	1	2	4	5	6	7	8	9	11
8.5	2.1401	1412	1424	1436	1448	1459	1471	1483	1494	1506	1	2	4	5	6	7	8	9	11
8.6	2.1518	1529	1541	1552	1564	1576	1587	1599	1610	1622	1	2	3	5	6	7	8	9	10
8.7	2.1633	1645	1656	1668	1679	1691	1702	1713	1725	1736	1	2	3	5	6	7	8	9	10
8.8	2.1748	1759	1770	1782	1793	1804	1815	1827	1838	1849	1	2	3	5	6	7	8	9	10
8.9	2.1861	1872	1883	1894	1905	1917	1928	1939	1950	1961	1	2	3	4	6	7	8	9	10
9.0	2.1972	1983	1994	2006	2017	2028	2039	2050	2061	2072	1	2	3	4	6	7	8	9	10
9.1	2.2083	2094	2105	2116	2127	2138	2148	2159	2170	2181	1	2	3	4	5	7	8	9	10
9.2	2.2192	2203	2214	2225	2235	2246	2257	2268	2279	2289	1	2	3	4	5	6	8	9	10
9.3	2.2300	2311	2322	2332	2343	2354	2364	2375	2386	2396	1	2	3	4	5	6	7	9	10
9.4	2.2407	2418	2428	2439	2450	2460	2471	2481	2492	2502	1	2	3	4	5	6	7	8	10
9.5	2.2513	2523	2534	2544	2555	2565	2576	2586	2597	2607	1	2	3	4	5	6	7	8	9
9.6	2.2618	2628	2638	2649	2659	2670	2680	2690	2701	2711	1	2	3	4	5	6	7	8	9
9.7	2.2721	2732	2742	2752	2762	2773	2783	2793	2803	2814	1	2	3	4	5	6	7	8	9
9.8	2.2824	2834	2844	2854	2865	2875	2885	2895	2905	2915	1	2	3	4	5	6	7	8	9
9.9	2.2925	2935	2946	2956	2966	2976	2986	2996	3006	3016	1	2	3	4	5	6	7	8	9
10.0	2.3026																		

Natural logarithms of 10⁻ⁿ

n	1	2	3	4	5	6	7	8	9
log _e 10 ⁻ⁿ	3.6974	5.3948	7.0922	10.7897	12.4871	14.1845	17.8819	19.5793	21.2767

Hyperbolic sines [$\sinh x = \frac{1}{2}(e^x - e^{-x})$]

X	0	1	2	3	4	5	6	7	8	9	avg diff
0.0	0.0000	0.0100	0.0200	0.0300	0.0400	0.0500	0.0600	0.0701	0.0801	0.0901	100
.1	0.1002	0.1102	0.1203	0.1304	0.1405	0.1506	0.1607	0.1708	0.1810	0.1911	101
.2	0.2013	0.2115	0.2218	0.2320	0.2423	0.2526	0.2629	0.2733	0.2837	0.2941	103
.3	0.3045	0.3150	0.3255	0.3360	0.3466	0.3572	0.3678	0.3785	0.3892	0.4000	106
.4	0.4108	0.4216	0.4325	0.4434	0.4543	0.4653	0.4764	0.4875	0.4986	0.5098	110
0.5	0.5211	0.5324	0.5438	0.5552	0.5666	0.5782	0.5897	0.6014	0.6131	0.6248	116
.6	0.6367	0.6485	0.6605	0.6725	0.6846	0.6967	0.7090	0.7213	0.7336	0.7461	122
.7	0.7586	0.7712	0.7838	0.7966	0.8094	0.8223	0.8353	0.8484	0.8615	0.8748	130
.8	0.8881	0.9015	0.9150	0.9286	0.9423	0.9561	0.9700	0.9840	0.9981	1.012	138
.9	1.027	1.041	1.055	1.070	1.085	1.099	1.114	1.129	1.145	1.160	15
1.0	1.175	1.191	1.206	1.222	1.238	1.254	1.270	1.286	1.303	1.319	16
.1	1.336	1.352	1.369	1.386	1.403	1.421	1.438	1.456	1.474	1.491	17
.2	1.509	1.528	1.546	1.564	1.583	1.602	1.621	1.640	1.659	1.679	19
.3	1.698	1.718	1.738	1.758	1.779	1.799	1.820	1.841	1.862	1.883	21
.4	1.904	1.926	1.948	1.970	1.992	2.014	2.037	2.060	2.083	2.106	22
1.5	2.129	2.153	2.177	2.201	2.225	2.250	2.274	2.299	2.324	2.350	25
.6	2.376	2.401	2.428	2.454	2.481	2.507	2.535	2.562	2.590	2.617	27
.7	2.646	2.674	2.703	2.732	2.761	2.790	2.820	2.850	2.881	2.911	30
.8	2.942	2.973	3.005	3.037	3.069	3.101	3.134	3.167	3.200	3.234	33
.9	3.268	3.303	3.337	3.372	3.408	3.443	3.479	3.516	3.552	3.589	36
2.0	3.627	3.665	3.703	3.741	3.780	3.820	3.859	3.899	3.940	3.981	39
.1	4.022	4.064	4.106	4.148	4.191	4.234	4.278	4.322	4.367	4.412	44
.2	4.457	4.503	4.549	4.596	4.643	4.691	4.739	4.788	4.837	4.887	48
.3	4.937	4.988	5.039	5.090	5.142	5.195	5.248	5.302	5.356	5.411	53
.4	5.466	5.522	5.578	5.635	5.693	5.751	5.810	5.869	5.929	5.989	58
2.5	6.050	6.112	6.174	6.237	6.300	6.365	6.429	6.495	6.561	6.627	64
.6	6.695	6.763	6.831	6.901	6.971	7.042	7.113	7.185	7.258	7.332	71
.7	7.406	7.481	7.557	7.634	7.711	7.789	7.868	7.948	8.028	8.110	79
.8	8.192	8.275	8.359	8.443	8.529	8.615	8.702	8.790	8.879	8.969	87
.9	9.060	9.151	9.244	9.337	9.431	9.527	9.623	9.720	9.819	9.918	96
3.0	10.02	10.12	10.22	10.32	10.43	10.53	10.64	10.75	10.86	10.97	11
.1	11.08	11.19	11.30	11.42	11.53	11.65	11.76	11.88	12.00	12.12	12
.2	12.25	12.37	12.49	12.62	12.75	12.88	13.01	13.14	13.27	13.40	13
.3	13.54	13.67	13.81	13.95	14.09	14.23	14.38	14.52	14.67	14.82	14
.4	14.97	15.12	15.27	15.42	15.58	15.73	15.89	16.05	16.21	16.38	16
3.5	16.54	16.71	16.88	17.05	17.22	17.39	17.57	17.74	17.92	18.10	17
.6	18.29	18.47	18.66	18.84	19.03	19.22	19.42	19.61	19.81	20.01	19
.7	20.21	20.41	20.62	20.83	21.04	21.25	21.46	21.68	21.90	22.12	21
.8	22.34	22.56	22.79	23.02	23.25	23.49	23.72	23.96	24.20	24.45	24
.9	24.69	24.94	25.19	25.44	25.70	25.96	26.22	26.48	26.75	27.02	26
4.0	27.29	27.56	27.84	28.12	28.40	28.69	28.98	29.27	29.56	29.86	29
.1	30.16	30.47	30.77	31.08	31.39	31.71	32.03	32.35	32.68	33.00	32
.2	33.34	33.67	34.01	34.35	34.70	35.05	35.40	35.75	36.11	36.48	35
.3	36.84	37.21	37.59	37.97	38.35	38.73	39.12	39.52	39.91	40.31	39
.4	40.72	41.13	41.54	41.96	42.38	42.81	43.24	43.67	44.11	44.56	43
4.5	45.00	45.46	45.91	46.37	46.84	47.31	47.79	48.27	48.75	49.24	47
.6	49.74	50.24	50.74	51.25	51.77	52.29	52.81	53.34	53.88	54.42	52
.7	54.97	55.52	56.08	56.64	57.21	57.79	58.37	58.96	59.55	60.15	58
.8	60.75	61.36	61.98	62.60	63.23	63.87	64.51	65.16	65.81	66.47	64
.9	67.14	67.82	68.50	69.19	69.88	70.58	71.29	72.01	72.73	73.46	71
5.0	74.20										

If $x > 5$, $\sinh x = \frac{1}{2}e^x$ and $\log_{10} \sinh x = (0.4343)x + 0.6990 - 1$, correct to four significant figures.

Hyperbolic cosines [$\cosh x = \frac{1}{2}(e^x + e^{-x})$]

X	0	1	2	3	4	5	6	7	8	9	avg diff
0.0	1.000	1.000	1.000	1.000	1.001	1.001	1.002	1.002	1.003	1.004	1
.1	1.005	1.006	1.007	1.008	1.010	1.011	1.013	1.014	1.016	1.018	2
.2	1.020	1.022	1.024	1.027	1.029	1.031	1.034	1.037	1.039	1.042	3
.3	1.045	1.048	1.052	1.055	1.058	1.062	1.066	1.069	1.073	1.077	4
.4	1.081	1.085	1.090	1.094	1.098	1.103	1.108	1.112	1.117	1.122	5
0.5	1.128	1.133	1.138	1.144	1.149	1.155	1.161	1.167	1.173	1.179	6
.6	1.185	1.192	1.198	1.205	1.212	1.219	1.226	1.233	1.240	1.248	7
.7	1.255	1.263	1.271	1.278	1.287	1.295	1.303	1.311	1.320	1.329	8
.8	1.337	1.346	1.355	1.365	1.374	1.384	1.393	1.403	1.413	1.423	10
.9	1.433	1.443	1.454	1.465	1.475	1.486	1.497	1.509	1.520	1.531	11
1.0	1.543	1.555	1.567	1.579	1.591	1.604	1.616	1.629	1.642	1.655	13
.1	1.669	1.682	1.696	1.709	1.723	1.737	1.752	1.766	1.781	1.796	14
.2	1.811	1.826	1.841	1.857	1.872	1.888	1.905	1.921	1.937	1.954	16
.3	1.971	1.988	2.005	2.023	2.040	2.058	2.076	2.095	2.113	2.132	18
.4	2.151	2.170	2.189	2.209	2.229	2.249	2.269	2.290	2.310	2.331	20
1.5	2.352	2.374	2.395	2.417	2.439	2.462	2.484	2.507	2.530	2.554	23
.6	2.577	2.601	2.625	2.650	2.675	2.700	2.725	2.750	2.776	2.802	25
.7	2.828	2.855	2.882	2.909	2.936	2.964	2.992	3.021	3.049	3.078	28
.8	3.107	3.137	3.167	3.197	3.228	3.259	3.290	3.321	3.353	3.385	31
.9	3.418	3.451	3.484	3.517	3.551	3.585	3.620	3.655	3.690	3.726	34
2.0	3.762	3.799	3.835	3.873	3.910	3.948	3.987	4.026	4.065	4.104	38
.1	4.144	4.185	4.226	4.267	4.309	4.351	4.393	4.436	4.480	4.524	42
.2	4.568	4.613	4.658	4.704	4.750	4.797	4.844	4.891	4.939	4.988	47
.3	5.037	5.087	5.137	5.188	5.239	5.290	5.343	5.395	5.449	5.503	52
.4	5.557	5.612	5.667	5.723	5.780	5.837	5.895	5.954	6.013	6.072	58
2.5	6.132	6.193	6.255	6.317	6.379	6.443	6.507	6.571	6.636	6.702	64
.6	6.769	6.836	6.904	6.973	7.042	7.112	7.183	7.255	7.327	7.400	70
.7	7.473	7.548	7.623	7.699	7.776	7.853	7.932	8.011	8.091	8.171	78
.8	8.253	8.335	8.418	8.502	8.587	8.673	8.759	8.847	8.935	9.024	86
.9	9.115	9.206	9.298	9.391	9.484	9.579	9.675	9.772	9.869	9.968	95
3.0	10.07	10.17	10.27	10.37	10.48	10.58	10.69	10.79	10.90	11.01	11
.1	11.12	11.23	11.35	11.46	11.57	11.69	11.81	11.92	12.04	12.16	12
.2	12.29	12.41	12.53	12.66	12.79	12.91	13.04	13.17	13.31	13.44	13
.3	13.57	13.71	13.85	13.99	14.13	14.27	14.41	14.56	14.70	14.85	14
.4	15.00	15.15	15.30	15.45	15.61	15.77	15.92	16.08	16.25	16.41	16
3.5	16.57	16.74	16.91	17.08	17.25	17.42	17.60	17.77	17.95	18.13	17
.6	18.31	18.50	18.68	18.87	19.06	19.25	19.44	19.64	19.84	20.03	19
.7	20.24	20.44	20.64	20.85	21.06	21.27	21.49	21.70	21.92	22.14	21
.8	22.36	22.59	22.81	23.04	23.27	23.51	23.74	23.98	24.22	24.47	23
.9	24.71	24.96	25.21	25.46	25.72	25.98	26.24	26.50	26.77	27.04	26
4.0	27.31	27.58	27.86	28.14	28.42	28.71	29.00	29.29	29.58	29.88	29
.1	30.18	30.48	30.79	31.10	31.41	31.72	32.04	32.37	32.69	33.02	32
.2	33.35	33.69	34.02	34.37	34.71	35.06	35.41	35.77	36.13	36.49	35
.3	36.86	37.23	37.60	37.98	38.36	38.75	39.13	39.53	39.93	40.33	39
.4	40.73	41.14	41.55	41.97	42.39	42.82	43.25	43.68	44.12	44.57	43
4.5	45.01	45.47	45.92	46.38	46.85	47.32	47.80	48.28	48.76	49.25	47
.6	49.75	50.25	50.75	51.26	51.78	52.30	52.82	53.35	53.89	54.43	52
.7	54.98	55.53	56.09	56.65	57.22	57.80	58.38	58.96	59.56	60.15	58
.8	60.76	61.37	61.99	62.61	63.24	63.87	64.52	65.16	65.82	66.48	64
.9	67.15	67.82	68.50	69.19	69.89	70.59	71.30	72.02	72.74	73.47	71
5.0	74.21										

If $x > 5$, $\cosh x = \frac{1}{2}e^x$, and $\log_{10} \cosh x = (0.4343)x + 0.6990 - 1$, correct to four significant figures.

Hyperbolic tangents [$\tanh x = (e^x - e^{-x}) / (e^x + e^{-x}) = \sinh x / \cosh x$]

X	0	1	2	3	4	5	6	7	8	9	avg diff
0.0	.0000	.0100	.0200	.0300	.0400	.0500	.0599	.0699	.0798	.0898	100
.1	.0997	.1096	.1194	.1293	.1391	.1489	.1587	.1684	.1781	.1878	98
.2	.1974	.2070	.2165	.2260	.2355	.2449	.2543	.2636	.2729	.2821	94
.3	.2913	.3004	.3095	.3185	.3275	.3364	.3452	.3540	.3627	.3714	89
.4	.3800	.3885	.3969	.4053	.4136	.4219	.4301	.4382	.4462	.4542	82
0.5	.4621	.4700	.4777	.4854	.4930	.5005	.5080	.5154	.5227	.5299	75
.6	.5370	.5441	.5511	.5581	.5649	.5717	.5784	.5850	.5915	.5980	67
.7	.6044	.6107	.6169	.6231	.6291	.6352	.6411	.6469	.6527	.6584	60
.8	.6640	.6696	.6751	.6805	.6858	.6911	.6963	.7014	.7064	.7114	52
.9	.7163	.7211	.7259	.7306	.7352	.7398	.7443	.7487	.7531	.7574	45
1.0	.7616	.7658	.7699	.7739	.7779	.7818	.7857	.7895	.7932	.7969	39
.1	.8005	.8041	.8076	.8110	.8144	.8178	.8210	.8243	.8275	.8306	33
.2	.8337	.8367	.8397	.8426	.8455	.8483	.8511	.8538	.8565	.8591	28
.3	.8617	.8643	.8668	.8693	.8717	.8741	.8764	.8787	.8810	.8832	24
.4	.8854	.8875	.8896	.8917	.8937	.8957	.8977	.8996	.9015	.9033	20
1.5	.9052	.9069	.9087	.9104	.9121	.9138	.9154	.9170	.9186	.9202	17
.6	.9217	.9232	.9246	.9261	.9275	.9289	.9302	.9316	.9329	.9342	14
.7	.9354	.9367	.9379	.9391	.9402	.9414	.9425	.9436	.9447	.9458	11
.8	.9468	.9478	.9488	.9498	.9508	.9518	.9527	.9536	.9545	.9554	9
.9	.9562	.9571	.9579	.9587	.9595	.9603	.9611	.9619	.9626	.9633	8
2.0	.9640	.9647	.9654	.9661	.9668	.9674	.9680	.9687	.9693	.9699	6
.1	.9705	.9710	.9716	.9722	.9727	.9732	.9738	.9743	.9748	.9753	5
.2	.9757	.9762	.9767	.9771	.9776	.9780	.9785	.9789	.9793	.9797	4
.3	.9801	.9805	.9809	.9812	.9816	.9820	.9823	.9827	.9830	.9834	4
.4	.9837	.9840	.9843	.9846	.9849	.9852	.9855	.9858	.9861	.9863	3
2.5	.9866	.9869	.9871	.9874	.9876	.9879	.9881	.9884	.9886	.9888	2
.6	.9890	.9892	.9895	.9897	.9899	.9901	.9903	.9905	.9906	.9908	2
.7	.9910	.9912	.9914	.9915	.9917	.9919	.9920	.9922	.9923	.9925	2
.8	.9926	.9928	.9929	.9931	.9932	.9933	.9935	.9936	.9937	.9938	1
.9	.9940	.9941	.9942	.9943	.9944	.9945	.9946	.9947	.9949	.9950	1
3.0	.9951	.9959	.9967	.9973	.9978	.9982	.9985	.9988	.9990	.9992	4
4.0	.9993	.9995	.9996	.9996	.9997	.9998	.9998	.9998	.9999	.9999	1
5.0	.9999										1

If $x > 5$, $\tanh x = 1.0000$ to four decimal places.

Multiples of 0.4343 [$0.43429448 = \log_{10} e$]

X	0	1	2	3	4	5	6	7	8	9
0.0	0.0000	0.0434	0.0869	0.1303	0.1737	0.2171	0.2606	0.3040	0.3474	0.3909
1.0	0.4343	0.4777	0.5212	0.5646	0.6080	0.6514	0.6949	0.7383	0.7817	0.8252
2.0	0.8686	0.9120	0.9554	0.9989	1.0423	1.0857	1.1292	1.1726	1.2160	1.2595
3.0	1.3029	1.3463	1.3897	1.4332	1.4766	1.5200	1.5635	1.6069	1.6503	1.6937
4.0	1.7372	1.7806	1.8240	1.8675	1.9109	1.9543	1.9978	2.0412	2.0846	2.1280
5.0	2.1715	2.2149	2.2583	2.3018	2.3452	2.3886	2.4320	2.4755	2.5189	2.5623
6.0	2.6058	2.6492	2.6926	2.7361	2.7795	2.8229	2.8663	2.9098	2.9532	2.9966
7.0	3.0401	3.0835	3.1269	3.1703	3.2138	3.2572	3.3006	3.3441	3.3875	3.4309
8.0	3.4744	3.5178	3.5612	3.6046	3.6481	3.6915	3.7349	3.7784	3.8218	3.8652
9.0	3.9087	3.9521	3.9955	4.0389	4.0824	4.1258	4.1692	4.2127	4.2561	4.2995

Multiples of 2.3026 [$2.3025851 = 1/0.4343 = \log_e 10$]

X	0	1	2	3	4	5	6	7	8	9
0.0	0.0000	0.2303	0.4605	0.6908	0.9210	1.1513	1.3816	1.6118	1.8421	2.0723
1.0	2.3026	2.5328	2.7631	2.9934	3.2236	3.4539	3.6841	3.9144	4.1447	4.3749
2.0	4.6052	4.8354	5.0657	5.2959	5.5262	5.7565	5.9867	6.2170	6.4472	6.6775
3.0	6.9078	7.1380	7.3683	7.5985	7.8288	8.0590	8.2893	8.5196	8.7498	8.9801
4.0	9.2103	9.4406	9.6709	9.9011	10.131	10.362	10.592	10.822	11.052	11.283
5.0	11.513	11.743	11.973	12.204	12.434	12.664	12.894	13.125	13.355	13.585
6.0	13.816	14.046	14.276	14.506	14.737	14.967	15.197	15.427	15.658	15.888
7.0	16.118	16.348	16.579	16.809	17.039	17.269	17.500	17.730	17.960	18.190
8.0	18.421	18.651	18.881	19.111	19.342	19.572	19.802	20.032	20.263	20.493
9.0	20.723	20.954	21.184	21.414	21.644	21.875	22.105	22.335	22.565	22.796

Table I— $J_0(z)$ Bessel functions

z	0	0.1	0.2	0.3	0.4	0.5	0.6	0.7	0.8	0.9
0	1.0000	0.9975	0.9900	0.9776	0.9604	0.9385	0.9120	0.8812	0.8463	0.8075
1	0.7652	0.7196	0.6711	0.6201	0.5669	0.5118	0.4554	0.3980	0.3400	0.2818
2	0.2239	0.1666	0.1104	0.0555	0.0025	-0.0484	-0.0968	-0.1424	-0.1850	-0.2243
3	-0.2601	-0.2921	-0.3202	-0.3443	-0.3643	-0.3801	-0.3918	-0.3992	-0.4026	-0.4018
4	-0.3971	-0.3887	-0.3766	-0.3610	-0.3423	-0.3205	-0.2961	-0.2693	-0.2404	-0.2097
5	-0.1776	-0.1443	-0.1103	-0.0758	-0.0412	-0.0068	+0.0270	0.0599	0.0917	0.1220
6	0.1506	0.1773	0.2017	0.2238	0.2433	0.2601	0.2740	0.2851	0.2931	0.2981
7	0.3001	0.2991	0.2951	0.2882	0.2786	0.2663	0.2516	0.2346	0.2154	0.1944
8	0.1717	0.1475	0.1222	0.0960	0.0692	0.0419	0.0146	-0.0125	-0.0392	-0.0653
9	-0.0903	-0.1142	-0.1367	-0.1577	-0.1768	-0.1939	-0.2090	-0.2218	-0.2323	-0.2403
10	-0.2459	-0.2490	-0.2496	-0.2477	-0.2434	-0.2366	-0.2276	-0.2164	-0.2032	-0.1881
11	-0.1712	-0.1528	-0.1330	-0.1121	-0.0902	-0.0677	-0.0446	-0.0213	+0.0020	0.0250
12	0.0477	0.0697	0.0908	0.1108	0.1296	0.1469	0.1626	0.1766	0.1887	0.1988
13	0.2069	0.2129	0.2167	0.2183	0.2177	0.2150	0.2101	0.2032	0.1943	0.1836
14	0.1711	0.1570	0.1414	0.1245	0.1065	0.0875	0.0679	0.0476	0.0271	0.0064
15	-0.0142	-0.0346	-0.0544	-0.0736	-0.0919	-0.1092	-0.1253	-0.1401	-0.1533	-0.1650

Table II— $J_1(z)$ continued Bessel functions

z	0	0.1	0.2	0.3	0.4	0.5	0.6	0.7	0.8	0.9
0	0.0000	0.0499	0.0995	0.1483	0.1960	0.2423	0.2867	0.3290	0.3688	0.4059
1	0.4401	0.4709	0.4983	0.5220	0.5419	0.5579	0.5699	0.5778	0.5815	0.5812
2	0.5767	0.5683	0.5560	0.5399	0.5202	0.4971	0.4708	0.4416	0.4097	0.3754
3	0.3391	0.3009	0.2613	0.2207	0.1792	0.1374	0.0955	0.0538	0.0128	-0.0272
4	-0.0660	-0.1033	-0.1386	-0.1719	-0.2028	-0.2311	-0.2566	-0.2791	-0.2985	-0.3147
5	-0.3276	-0.3371	-0.3432	-0.3460	-0.3453	-0.3414	-0.3343	-0.3241	-0.3110	-0.2951
6	-0.2767	-0.2559	-0.2329	-0.2081	-0.1816	-0.1538	-0.1250	-0.0953	-0.0652	-0.0349
7	-0.0047	+0.0252	0.0543	0.0826	0.1096	0.1352	0.1592	0.1813	0.2014	0.2192
8	0.2346	0.2476	0.2580	0.2657	0.2708	0.2731	0.2728	0.2697	0.2641	0.2559
9	0.2453	0.2324	0.2174	0.2004	0.1816	0.1613	0.1395	0.1166	0.0928	0.0684
10	0.0435	0.0184	-0.0066	-0.0313	-0.0555	-0.0789	-0.1012	-0.1224	-0.1422	-0.1603
11	-0.1768	-0.1913	-0.2039	-0.2143	-0.2225	-0.2284	-0.2320	-0.2333	-0.2323	-0.2290
12	-0.2234	-0.2157	-0.2060	-0.1943	-0.1807	-0.1655	-0.1487	-0.1307	-0.1114	-0.0912
13	-0.0703	-0.0489	-0.0271	-0.0052	+0.0166	0.0380	0.0590	0.0791	0.0984	0.1165
14	0.1334	0.1488	0.1626	0.1747	0.1850	0.1934	0.1999	0.2043	0.2066	0.2069
15	0.2051	0.2013	0.1955	0.1879	0.1784	0.1672	0.1544	0.1402	0.1247	0.1080

Table III— $J_2(z)$ continued Bessel functions

z	0	0.1	0.2	0.3	0.4	0.5	0.6	0.7	0.8	0.9
0	0.0000	0.0012	0.0050	0.0112	0.0197	0.0306	0.0437	0.0588	0.0758	0.0946
1	0.1149	0.1366	0.1593	0.1830	0.2074	0.2321	0.2570	0.2817	0.3061	0.3299
2	0.3528	0.3746	0.3951	0.4139	0.4310	0.4461	0.4590	0.4696	0.4777	0.4832
3	0.4861	0.4862	0.4835	0.4780	0.4697	0.4586	0.4448	0.4283	0.4093	0.3879
4	0.3641	0.3383	0.3105	0.2811	0.2501	0.2178	0.1846	0.1506	0.1161	0.0813

Table IV— $J_3(z)$

z	0	0.1	0.2	0.3	0.4	0.5	0.6	0.7	0.8	0.9
0	0.0000	0.0000	0.0002	0.0006	0.0013	0.0026	0.0044	0.0069	0.0102	0.0144
1	0.0196	0.0257	0.0329	0.0411	0.0505	0.0610	0.0725	0.0851	0.0988	0.1134
2	0.1289	0.1453	0.1623	0.1800	0.1981	0.2166	0.2353	0.2540	0.2727	0.2911
3	0.3091	0.3264	0.3431	0.3588	0.3734	0.3868	0.3988	0.4092	0.4180	0.4250
4	0.4302	0.4333	0.4344	0.4333	0.4301	0.4247	0.4171	0.4072	0.3952	0.3811

Table V— $J_4(z)$

z	0	0.1	0.2	0.3	0.4	0.5	0.6	0.7	0.8	0.9
0	0.0000	0.0000	0.0000	0.0000	0.0001	0.0002	0.0003	0.0006	0.0010	0.0016
1	0.0025	0.0036	0.0050	0.0068	0.0091	0.0118	0.0150	0.0188	0.0232	0.0283
2	0.0340	0.0405	0.0476	0.0556	0.0643	0.0738	0.0840	0.0950	0.1067	0.1190
3	0.1320	0.1456	0.1597	0.1743	0.1891	0.2044	0.2198	0.2353	0.2507	0.2661
4	0.2811	0.2958	0.3100	0.3236	0.3365	0.3484	0.3594	0.3693	0.3780	0.3853

Table VI

continued Bessel functions

322

p	$J_p(1)$	$J_p(2)$	$J_p(3)$	$J_p(4)$	$J_p(5)$	$J_p(6)$	$J_p(7)$	$J_p(8)$	$J_p(9)$	$J_p(10)$	$J_p(11)$	$J_p(12)$	$J_p(13)$	$J_p(14)$
0														
0.5	+ .7652 + .6714	+ .2239 + .5130	- .2601 + .06501	- .3971 - .3019	- .1776 - .3422	+ .1506 - .09102	+ .3001 + .1981	+ .1717 + .2791	- .09033 + .1096	- .2459 - .1373	- .1712 - .2406	+ .04769 - .1236	+ .2069 + .09298	+ .1711 + .2112
1.0														
1.5	+ .4401 + .2403	+ .5767 + .4913	+ .3391 + .4777	- .06604 + .1853	- .3276 - .1697	- .2767 - .3279	- .04683 - .1991	+ .2346 + .07593	+ .2453 + .2545	+ .04347 + .1980	- .1768 - .02293	- .2234 - .2047	- .07032 - .1937	+ .1334 - .01407
2.0														
2.5	+ .1149 + .04950	+ .3528 + .2239	+ .4861 + .4127	+ .3641 + .4409	+ .04657 + .2404	- .2429 - .07295	- .3014 - .2834	- .1130 - .2506	+ .1448 - .02477	+ .2546 + .1967	+ .1390 + .2343	- .08493 + .07242	- .2177 - .1377	- .1520 - .2143
3.0														
3.5	+ .01956 + .07186	+ .1289 + .06852	+ .3091 + .2101	+ .4302 + .3658	+ .3648 + .4100	+ .1148 + .2671	- .1676 - .03403	- .2911 - .2326	- .1809 - .2683	+ .05838 - .09965	+ .2273 + .1294	+ .1951 + .2348	+ .03320 + .1407	- .1768 - .06245
4.0														
4.5	+ .02477 + .0807	+ .03400 + .01589	+ .1320 + .07760	+ .2811 + .1993	+ .3912 + .3337	+ .3576 + .3846	+ .1578 + .2800	- .1054 + .04712	- .2655 - .1839	- .2196 - .2644	- .01504 - .1519	+ .1825 + .06457	+ .2193 + .2134	+ .07624 + .1830
5.0														
5.5	+ .02498 + .074	+ .07704 + .02973	+ .04303 + .02266	+ .1321 + .08261	+ .2611 + .1906	+ .3621 + .3098	+ .3479 + .3634	+ .1858 + .2856	- .05504 + .08439	- .2341 - .1401	- .2383 - .2538	- .07347 - .1864	+ .1316 + .07055	+ .2204 + .1801
6.0														
6.5	+ .02094 + .06	+ .01202 + .0467	+ .01139 + .04593	+ .04909 + .02787	+ .1310 + .08558	+ .2458 + .1833	+ .3392 + .2911	+ .3376 + .3456	+ .2043 + .2870	- .01446 + .1123	- .2016 - .1018	- .2437 - .2354	- .1180 - .2075	+ .08117 - .04151
7.0														
7.5	+ .01502 —	+ .01749 —	+ .02547 —	+ .01518 —	+ .05338 —	+ .1296 + .08741	+ .2336 + .1772	+ .3206 + .2759	+ .3275 + .3302	+ .2167 + .2861	+ .01838 + .1334	- .1703 - .06865	- .2406 - .2145	- .1508 - .2187
8.0														
8.5	+ .079422 —	+ .042218 —	+ .04934 —	+ .04029 —	+ .01841 —	+ .05653 + .03520	+ .1280 + .08854	+ .2235 + .1718	+ .3051 + .2633	+ .3179 + .3169	+ .2250 + .2838	+ .04510 + .1496	- .1410 - .04006	- .2320 - .1928
9.0														
9.5	+ .05249 —	+ .02492 —	+ .04844 —	+ .03986 —	+ .05520 —	+ .02117 + .01232	+ .05892 + .03785	+ .1263 + .08921	+ .2149 + .1672	+ .2919 + .2526	+ .3089 + .3051	+ .2304 + .2806	+ .06698 + .1621	- .1143 - .01541
10.0	+ .02631	+ .02515	+ .041293	+ .031950	+ .031468	+ .046964	+ .02354	+ .06077	+ .1247	+ .2075	+ .2804	+ .3005	+ .2338	+ .08501

Note: .07186 = .007186

.0807 = .00807

A

- | | | | |
|-------------------------------------|----------|------------------------------------|---------------|
| Absorption coefficients | 170 | Alternating current | |
| Absorption units | 169 | average | 99 |
| Accelerating electrode, cathode ray | 137 | effective | 99 |
| Acoustics | 165-178 | supplies | 25 |
| absorption coefficients | 170 | Altitude, atmospheric pressure | 22 |
| absorption units | 169 | American | |
| amplifier power capacity | 172, 173 | noise units | 190, 191 |
| attenuation constant | 169 | war standards, capacitors | 55 |
| coefficients | 170 | war standards, resistors | 52 |
| equal-loudness contours | 178 | wire gauge | 35, 36 |
| music levels | 174 | Ampere turns, cathode-ray focusing | 138 |
| music ranges | 174 | Amplification, Amplifiers | |
| music, requirements | 172 | audio | 143 |
| noise | 177 | beam power tube | 161, 162, 163 |
| noise reduction coefficients | 170 | cathode follower | 156, 157, 158 |
| open-window units | 169 | circuits | 155 |
| optimum reverberation | 166-169 | class A | 143, 153, 154 |
| pressure | 176 | class AB | 143, 153, 154 |
| public-address requirements | 171-173 | class B | 143, 154, 155 |
| reverberation | 165 | class B r-f | 152, 153 |
| computation | 169-171 | class C | 143 |
| room sizes | 165, 166 | classes | 155, 156, 157 |
| sound level | 176 | constant-current characteristics | 145 |
| sound pressure | 176 | design | 143 |
| speech frequency | 175 | class A and AB | 153 |
| speech intensity | 175 | class AB and B | 154 |
| speech requirements | 172, 173 | class B | 152 |
| standing waves | 165 | class C | 147 |
| Admittance | 64-70 | distortion | 164 |
| Admittance equations | 86 | efficiency | 143 |
| Advance wire | 44 | factor | 127, 129 |
| Aerial—see Antenna | | feedback | 159 |
| Air cooling, tube | 131 | general design | 143-146 |
| Air-cored coils | 58, 59 | graphical design | 146-155 |
| Algebraic formulas | 294-296 | grid current | 143 |
| Alloys | | grounded cathode | 156 |
| melting point | 44 | grounded grid | 156 |
| physical constants | 44 | grounded plate | 156 |
| resistance | 44 | harmonic distortion | 153, 164 |
| specific gravity | 44 | negative feedback | 159, 164 |
| temperature coefficient | 44 | operating data | 143 |

Amplification, Amplifiers—Cable, radio frequency

Amplification, Amplifiers <i>continued</i>		Atomic weights	19
plate modulation	149	Attenuation, Attenuator	100-114
push-pull	143	balanced O	106
radio-frequency	143	balanced H	106
resistance coupled	158, 159	bridged H	106, 110
sizes, public address	171	bridged T	106, 110
transfer characteristics	148	circular wave guides	213-217
tube	143-164	H	114
Amplitude modulation	86, 87, 88, 288	ladder	101, 102
Angles, approximations for	296	load impedance	104
Angle of radiation	261	minimum loss	106, 112
Anode current—see Current, plate		mismatch	198
Antennas—see also Radiators	250-271	open-wire pairs	181
angle, field intensity	255	symmetrical H	106, 108
array, radiation	265	symmetrical O	110
arrays	263-271	symmetrical π	110
binomial array	267	symmetrical T	106, 108
broadside directivity	265	T	114
dipole	258, 259, 265	telephone cable	183, 184
field intensity	250-253, 258, 259	telephone lines	180, 181, 182, 186
radiated power	258, 259	u-h-f lines	206
electric, magnetic components	250	unbalanced π	106
end-fed conductor radiation	260	unbalanced T	106
field near dipole	251	wave guide	216, 217
height		Audible spectrum	175, 176
field intensity	256	Audio reactors	122
impedance	257	Audio transformer	122
reactance	257	Auto transformer	122
resistance	257		
horn	217	B	
L and T	224	Balanced	
loop	265, 270	H attenuator	106
vertically stacked, gain	270	line, impedance	196
maximum radiation	261	shielded, impedance	196
minimum radiation	261	O attenuator	106
noise	244, 246, 248	Band-elimination filters	116
parallel to screen, radiation	269	Band-pass filters	116
radiation		Bandwidth	32
angle	261	noise	247
dipole	264	Barometer, atmospheric pressure	22
horizontal	269	Bauds	192
loop	264	Beaded line, impedance	196
pattern	263, 264	Bell System carrier frequencies	185
turnstile	264	Bessel functions	318-321
two wires	269	Binomial array	267
resistance, reactance components	257	theorem	297
rhombic	261-263	Birmingham wire gauge	36
single-lobe directivity	266	Blocking oscillator	272
tangential magnetic field	250, 251	Bridged	
top-loaded	224	H attenuator	106, 110
vertical	224, 254-258	T attenuator	100, 106, 110
field strength	255-258	Brightness, cathode ray	139
polarized	253, 254	British wire gauge	36
Areas of plane figures	291-293	Broadside directivity	265
Arithmetical progression	296	B & S wire gauge	35, 36
Army-Navy, preferred tubes	142		
Army-Navy radio-frequency cables	201-203	C	
Arrays, antenna	263-271	Cable, radio frequency	201
Atmospheric noise	244, 245	attenuation	204
pressure	22		
Atomic number	19		

Calculus, integrals—Cut-off voltage, cathode ray

Calculus, integrals	300-302	Condenser—see Capacitor	
Capacitance, Capacitor	52, 55-57	Conductance, Conductor	68
ceramic	57	ground	224
charge	92	mutual	129
color code	52	solid, skin effect	73
discharge	92	telephone line	182, 183
frequency	61, 62, 63	tubular, skin effect	73
mica	55, 56	Cone-sphere resonator	222
parallel plate	75	Cone, volume	292
reactance	61, 75	Constantan, thermocouples	46, 47
telephone line	179, 180, 182, 183	Continuous waves	33
transmission line	194	Control	
Capacity—see Capacitance		characteristic, cathode ray	138
Carbon, thermocouples	46, 47	electrode, cathode ray	136
Carrier systems	185-187	grid	128
telegraph, frequency	187	Conversion factors	11
telephone, frequency	186	Cooling water	131
Cathode—see also Filament		temperature rise	131
follower	156, 157, 158	Copper	
Cathode-ray tubes—see Tubes, cathode ray		resistance	45
Cavities, resonant	219, 220	stranded, AWG	38
CCIF noise units	191	stranded conductors	38
Ceramic beads	196	stranded, resistance	38
capacitors	57	stranded, weight	38
Characteristic impedance—see Impedance		thermocouples	46, 47
Chemical symbols	19	wire	37, 60, 126
Chokes, iron cored, design of	122-126	American gauge (AWG)	36, 123
Chromel, thermocouples	46, 47	attenuation per mile	37
Circle, area	292	Birmingham gauge (BWG)	36
Circuits		British standard	36
coupled tuned, phase shift	84	Brown and Sharpe	36, 123
overcoupled	84, 85	characteristic impedance	37
selective	80-86	current capacity	126
single tuned, phase shift	81	enameled	126
uhf	134	English-metric units	36
Circular wave guides	213-217	Imperial standard (SWG)	36
Clearance hole, screws	39	resistance	35, 36, 37, 126
Climate	23	size AWG	37
Clipped sawtooth wave	284	strength	37
Coating, tropical, marine protection	50	tables	35, 36, 38, 60, 126
Coaxial line		weight	35, 36, 37
cable	188	Core, reactor	123
characteristic impedance	196	Core, transformer	123
copper	206	Cosh, table of	317
resonator	222	Cosmic noise	244-246
surge impedance	195	Cosmic rays	28
Code, color	52	Coupled section, impedance matching	200
Code, telegraph	193	Coupling	
Coefficient of coupling	79	coefficient	79
Coil—see Inductance, Inductor		optimum	79
Color code	52	phase shift	84
capacitor	52	two circuits	79
Color temperature, metals	43	Crystal detectors	142
Combinations, permutations	297	Current	
Common logarithms	304, 305	average	99
Communication spectrum	28	characteristic	129
Complex hyperbolic functions	299	effective	99
Complex quantities, formulas	294	ratio, decibels	34
Composition resistors, color code	52	two-mesh network	78
		Cut-off frequency, telephone cable	183, 184
		Cut-off voltage, cathode ray	138

Cylinder, area—Filters

Cylinder, area	293	Electromagnetic units	16, 17, 251
volume	293	Electromotive force, psophometric	189
Cylindrical wave guides	213-217	Electromotive force, series of elements	18
D		Electron, Electronics—see also Tubes	
Damped waves	33, 287	differentiation	276, 277
Decibels	34	inertia	135
nepers	34	integration	274, 275
Decimals, inch	14	velocity, cathode ray	140
Deflection, cathode-ray		Elementary dipole	250
electrode	137, 139	Elements	
factor	138	atomic number	19
sensitivity	139, 140	atomic weight	19
Delta-wye transformation	86	emf series	18
Deviation, frequency	30	symbols	19
Diamond antennas	261-263	Ellipse, area	292
Dielectric constant	40	Emission	33
ground	224	frequency bands	32
Dielectric strength	40	tube	128, 133
Diffraction	238	EMU units	16, 17
Dimensions, conversion	11	End-fed conductor radiation	260
Diode		Equations, admittance	86
lines	129	Equations, impedance	86
perveance	129	Equivalents	11
plate current	129	ESU units	16, 17
power supply	118, 119	European noise units	190
Dipole		E waves	207
electric	250	Exponentials	317
field intensity	250-252	Exponential wave	287
half wave, field intensity	258		
magnetic	250	F	
radiation pattern	264	Factors, conversion	11
Direct-current supplies	25	Feedback	159, 164
Directive antenna arrays	263	Feedback, relaxation oscillator	272
Dissipation, tube	129	Feeder—see Transmission line	
Distance		Feeling, acoustic threshold	178
ranges	240	Field Intensity—see also Radiation	
uhf	238	antenna angle	255
reflected signal	244	antenna height	255
Distortion factor	164	dipole	250
Distributed constants, telephone cable		end-fed conductor	260
	182, 184	meter	245
D layer	226, 227	surface-wave	224, 225
Driver transformer	122	vertical antenna	253
Dry-bulb thermometer	20	Field strength—see Field intensity,	
Dynamic resistance, parallel tuned circuit	76	Radiation	
		Filaments	
E		oxide coated	132
Ear sensitivity	178	reactivation	134
Earth—see also Ground		thoriated tungsten	132
distances	240	transformer	122
magnetic field	141	tungsten	132
Echo, radio, time	244	Filters	
EEI-NEMA-RMA noise meter	245	band elimination	116
E layer	227	band pass	116
sporadic	227	constant K	116, 117
Electric circuit formulas	74-100	high pass	88-91, 117
Electric dipole	250	low pass	88-91, 117
Electrode characteristic	129	networks	115, 116, 117
Electromagnetic frequency spectrum	28	power supply	88, 118-121
		RC, RL, LC	88-91

Filters continued			
reactors	123	Geometrical progression	297
rectifier	120	Giorgi unit	16
series M	117	Great-circle calculations	240-243
shunt M	117	Greek alphabet	15
3-element series	116	Grid voltage, critical	129
3-element shunt	116	Ground	
Finishes, tropical, marine	50	conductivity	224
Flow of water	49	dielectric constant	224
Focusing, cathode ray		reflection	240
ampere turns	138	types	224
current	138	wave	224
electrode	137, 139	field intensity, frequency	239
voltage	138	Guides, wave	207
Forced-air cooling, tube	131		
Forecasts, propagation	231-236	H	
Foreign countries, power supplies	24	Harmonics—see also Distortion	
Form factor	58, 59	intensity	32
Formulas		Hearing, equal loudness	178
electric circuit	74-100	High frequency—see also Radio frequency	
impedance	64-70	maximum usable	229
mathematical	291-302	propagation	226
mensuration	291, 292	resistance	71
Fourier analysis	277-287	High-pass filters	117
graphical solution	279, 280	Horns, wave guide	217
Fractional sine wave	285	Horsepower vs torque	51
Fractions, inch-metric equivalents	14	H pad	114
Frequency		Humidity	
abbreviations	28	effect on reactor	123
allocation		effect on transformer	123
carrier telegraph	187	relative	20
carrier telephone	186	temperature	20
J carrier	185	H waves	207
K carrier	185	Hyperbolic	
L type	188	cosines	317
program	187	functions	299
telephony, high frequency	187	sines	316
bands	30, 32	tangents	318
capacitance, inductance	61, 62, 63		
classifications, radio	28	I	
cut-off, telephone cable	183, 184	Impedance	
designations	28	antenna height	257
modulation	288	balanced line	196
power supplies	25	beaded line	196
printer telegraph	192	coaxial line	196
range, music	174	formula	64-70, 86
range, speech	174	matching, coupled section	200
reactance	61	matching, shorted, open stub	199
spectrum, electromagnetic	28	open 2-wire line	196
tolerances	30	parallel	76
wavelength	29	wires	197
Frying noise	189	power transfer	78
F ₁ layer	227	shielded balanced line	196
F ₂ layer	227, 228	telephone cable	183, 184
		telephone line	180, 182
		transmission line	194
		wire and ground	197
		wire and shield	197
		2-mesh network	76, 77
		2 paralld wire and ground	197
		2 wires and ground	197
		4-wire line	197
G			
Galvanic series, metals	18		
Gamma rays	28		
Gaps, protective	123		
Gas tube oscillator	272		
Gaussian unit	16		

Imperial wire gauge—Metal

Imperial wire gauge	36	Latitude, distances	240
Inductance, inductor		L carrier system	188
charge	95-98	LC filters	88-91
discharge	95	Lead, solder melting point	47
formulas	58, 74	Leakance, telephone line	179, 180
frequency	61, 62, 63	Letter symbols, elements	19
reactance	61, 75	Letter symbols, Greek	15
ring	74	Life, tube	133
single-layer solenoids	58, 59	Light spectrum	28
telephone line	179, 180, 182, 183	Light, velocity	28
transmission line	194	Line-of-sight distance	237-240
Inertia, electron	135	Lines, transmission—see Transmission	
Input transformer	122	lines	
Insulation, insulating materials	40	Loading, telephone cable	182, 184
air	48	Loading constants, telephone cable	182
dielectric constant	40	Logarithms, common	304-305
dielectric strength	40	Logarithms, natural	314, 315
electrical properties	40	Longitude and time	27
physical properties	40	Longitude, distances	240
plastics, trade names	41	Long waves, propagation	224-226
power factor	40	Loop antennas, stacked	270
resistivity	40	Loop mile constants	184
softening point	40	Loop, radiation pattern	264
thermal expansion	40	Loudness contours	178
Integrals	300-302	Loudspeaker impedance	171
Integration, electronic	274	Loudspeaker, wire sizes	171
Insensifier electrode, cathode ray	137	Low frequencies, propagation	224-226
Interference—see Noise		Low-pass filters	117
International regulations	30	L type, carrier modulation	188
Interstage transformer	122		
Inverse-distance fields	224		
Inverse feedback	159, 164		
Ion, emf series	18		
Ionization, ionosphere—see also Propagation			
density	228, 229		
D layer	226		
E layer	227		
sporadic	227		
F ₁ layer	227		
F ₂ layer	228		
Iron, thermocouples	46, 47		
Isolation transformer	122		
Isosceles-triangle wave	283		
I.T. & T. System carrier frequencies	185		
Iterative impedance—see Transmission-line impedance			
J			
J type carrier systems	185		
K			
Kelvin, operating temperature	132		
Kennedy-Heaviside Layer—see Ionosphere			
Klystrons	135, 142		
K type carrier systems	185		
L			
Ladder attenuator	101-104		
L antennas	224		

M

Machine screws	
head styles	38
hole sizes	39
length	38
special	38
standard	38
Maclaurin's theorem	297
Magnet wire data—see also Copper wire	60
Magnetic dipole	250
Magnetic focusing, cathode ray	141
Magnetic shielding, cathode ray	139
Magnetrons	134, 142
Mains, voltage and frequency	25
Man-made noise	244-246
Marine, finishes and materials	50
Mathematical formulas	288-299, 291-302
Mathematical tables	304-322
Maximum usable frequency	229, 230
Medium frequencies, propagation	224
Medium waves, propagation	224-226
Melting point, metals	43, 44, 47
Mensuration formulas	291-293
Mercury, inches	22
Metal	
color heated	43
emf series	18
melting point	43, 44, 47
physical constants	44
position in galvanic series	18

Metal <i>continued</i>			
resistance		44	
specific gravity		44	
temperature		43	
temperature coefficient		44	
Metric equivalents		14	
Mica capacitors, identification		55	
Minimum-loss pads	106, 112, 113		
Mismatch, attenuation		198	
MKS system		16	
Modulation, Modulator			
amplitude	86, 87, 88, 288		
characteristic, cathode ray		138	
classes		32	
frequency		288	
L type carrier		188	
percentage		87	
pulse		290	
transformer		122	
waveforms		283	
Moisture, humidity		20	
Multi-element array	263-271		
Multiple-hop transmission	223-230		
Multiples of 2.3026		318	
Multiples of 0.4343		318	
Multivibrator		273	
Music, frequency ranges		174	
Music, intensity levels		174	
Mutual conductance—see Tubes			
N			
Navy-Army preferred tubes		142	
Navy-Army radio-frequency cables	201-203		
Negative feedback	159-164		
Nepers—decibels		34	
Networks	100-114		
filter		115	
theorems		74	
2-mesh, current		78	
2-mesh, impedance	76, 77		
New York, magnetic field at		141	
Noise			
acoustic		177	
atmospheric	244, 245		
cosmic	244-246		
frying		189	
levels	177, 190		
line		189	
man-made	244-246		
measurement	189-191, 249		
meter		245	
psophometric		189	
radio	244-249		
receiver, antenna	244, 246, 248		
reduction coefficients		170	
room		189	
thermal agitation	244, 246, 248		
to-signal ratio	248, 249		
units		190	
Nonsinusoidal waves	272-287		
Nuts, screws			39
Nyquist diagram			161
O			
Oblique-angled triangle, solution			298
Open stub, impedance matching			199
Open-window units			169
Open-wire pairs			179-181
Optical horizon			238
Optical line-of-sight distance			238
Optimum coupling			79
Oscillation, Oscillator			147
blocking			272
feedback, relaxation			272
gas tube			272
multivibrator			273
relaxation			272, 273
squegging			273
van der Pol			273
Oscillogram, modulation percentage			87
Output transformer			122
Overcoupled circuits			84
Oxide-coated cathode			132
P			
Pads, minimum loss			112, 113
Pads, T and H			114
Paint, tropical, marine			50
Parabola, area			292
Parallel circuit, impedance			68, 69, 70
Parallel impedance			76
Parallelogram, area			291
Parallel wires, impedance			195, 197
Penetration of current			71
Percentage modulation			87
Permutations, combinations			297
Perveance, diode, triode			129
Phase angle			64-70
Phase shift, coupled tuned circuits			84
Phase shift, single-tuned circuits			81
Phase shift, telephone lines			182
Phototubes			142
Pi section attenuators			100
Pi-tee transformation			86
Plane figures, areas			291-293
Plastics, composition			41
Plastics, trade names			41
Plate current, diode, triode			129
Plate resistance			128
Plate transformer			122
protective gaps			123
Platinum, thermocouples			46, 47
Polygon, area			291
Positive-grid tubes			135
Post-accelerating electrode, cathode			
ray			137
Potential, element series			18
Power			
dipole radiation			258
factor			40

Power—Reactance, Reactor

<i>Power continued</i>	
ratio to decibels	34
supplies	
foreign countries	25
filters, rectifiers	88, 118-121
transformer	122
design	124
transfer between impedances	78
transfer between two meshes	78, 79
Preaccelerating electrode, cathode ray	137
Precipitation extremes	23
Precipitation, world	24
Pressure	
acoustic	176
atmospheric	22
reactor	123
transformer	123
wind	42
Primary constants	180
Primary emission	128
Principle of superposition	74
Printer telegraph frequency	192
Printer telegraph, speed	192
Prism resonator	222
Program carrier, frequency	187
Progression, arithmetical	296
Progression, geometrical	297
Propagation—see also Attenuation	
antenna height	238
constant	180
toll cable	182
diffraction	238
distances	238, 240
calculation	240
echo	244
D layer	226
echo time	244
E layer	227
sporadic	227
forecasts	231-236
frequency vs ground wave	239
F ₁ layer	227
F ₂ layer	228
good earth	225
height of antenna	238
high frequencies	226
line of sight	238
long waves	224
low frequencies	224
maximum usable frequencies	229
medium frequencies	224
medium waves	224-226
optical horizon	238
over ground	225
poor earth	225
radio	224-249
radio horizon	238
radiotelephone fields required	235
range	238
sea water	226
short waves	226-230
signal strength required	235

<i>Propagation continued</i>	
sky wave	227
sporadic E	227
surface waves	225
telephone cable	182, 184
telephone lines	180
waves in guides	207
Protective gaps	123
reactors	123
transformers	123
Psophometric electromotive force	189-191
Public-address requirements	171
Pulse-frequency modulation	290
Pulse modulation	290
Pulse modulators	142
Pyramide, volume	293

Q

Q, resonators	222
Quadratic equation	296

R

<i>Radiation, Radiator—see also Antenna</i>	
angle	261
array antenna	265
binomial array	267
cooling, tube	131
dipole	264
end-fed conductor	260
horizontal wire	269
loop	264
pattern	263-264
power, dipole	258
spectrum	28
turnstile antenna	264
vertical	224, 254
wire parallel to screen	269
2 wires	269
Radio frequency	
cable	201
attenuation	204
classifications	28
resistance	71
radio horizon	238
radio noise	244-249
radio path horizon	237
radio path length	238
radiotelephone, fields required	235
Rainfall	23, 24
RC filters	88-91
<i>Reactance, Reactor</i>	
antenna height	257
audio	122
capacitor	75
charts	61, 62, 63
cores	123
filter	123
frequency	61, 62, 63
humidity	123
inductor	75

Reactance, Reactor—Spacing, telephone lines

Reactance, Reactor <i>continued</i>		RL filters	88-91
iron-core	122-126	RMA standards, capacitors	55
major types	122, 123	RMA standards, resistors	52
pressure	123	Room acoustics	165-178
protective gaps	123	Room noise	189
saturable	123		
temperature	123	S	
wave-filter	123	Saturable reactors	123
Receiver noise	244, 246, 248	Saturation, percent	20
Reciprocity theorem	74	Sawtooth wave	284, 285
Rectangular wave	282	Scott transformer	122
Rectangular wave guides	208	Screen grid	128
Rectification, Rectifier		cathode ray	137
circuits	118, 119	Screws, machine	
full-wave	118, 119	head styles	38
half-wave	118, 119	hole sizes	39
power supply	118-121	length	38
wave analysis	287	special	38
Recurrent wave forms, Fourier analysis	277-280	standard	38
Reflected signal, time interval	244	Sea water, propagation	226
Reflection coefficient	240	Secondary emission	128
Reflector, antenna	269	Sector circle area	292
Refractive index	240	Segment circle area	292
Relative humidity	20	Selective circuits	80-86
Relaxation oscillators	272, 273	Self inductance—see Inductance	
Resistance, Resistor	52	Series circuit	
antenna height	257	charge	95
copper wire	35, 36	discharge	95
coupled amplifier	158	impedance formulas	68, 69, 70
high frequency	71	sinusoidal voltage	98
insulating materials	40	Series M filter	117
parallel circuit	76	Series 3-element filter	116
radio frequency	71	Shielded balanced line impedance	196
skin effect	71	Shorted stub, impedance matching	199
standard color code	53	Short waves, maximum usable fre-	
telephone line	179, 180, 182, 183	quencies	229
Resonance, Resonator		Short waves, propagation	226
cavities	219	Shunt M filter	117
circular	222	Shunt 3-element filter	116
coaxial	222	Signal strength—see Attenuation, Field	
cylinder	222	intensity, Propagation	
frequency, filters	89	Signal-to-noise ratio	248, 249
frequency, series circuit	75	Silicon carbide, thermocouples	46, 47
prism	222	Simpson's rule	293
rectangular	221, 222	Sines, hyperbolic	316
selectivity	80	Sine wave, fractional	235
sphere-cone	222	Sine wave, full	286
spherical	221, 222	Sine wave, half	286
square prism	222	Single-hop transmission	228, 229
waves in	207	Sinh, table of	316
Reverberation time	165	Sinusoidal voltage	98
R-F cables, Army-Navy	201-203	Skin effect	71, 72, 73
attenuation	204	Sky reflection	228, 229
R-F transmission lines—see also		Sky-wave—see Attenuation, Field in-	
Transmission lines	194-206	tensity, Propagation	
RG-/U cable	201-204	Solder, melting point	47
Rhodium, thermocouples	46, 47	Solenoids, inductance	58, 59
Rhombic antennas	261-263	Sound level, acoustic	176
Right-angle triangle, solution	298	Sound, noise levels	177
Ripple frequency	118-121	Space-charge grid	123
Ripple voltage	118-121	Spacing, telephone lines	180

Spark-gap breakdown voltages—Torque vs horsepower

Spark-gap breakdown voltages	48	Telephone cable <i>continued</i>	
Speech, frequency ranges	175	impedance	183, 184
Speech, intensity levels	175	loading	182, 184
Speed, printer telegraph	192	constants	182
Speed, telegraph	192	noise	190
Sphere, area	293	propagation	182, 184
cone resonator	222	velocity	183, 184
volume	293	wavelength	183, 184
Spherical trigonometry	240	Telephone carrier systems	185-187
Spiral-4 cable	183	Telephone line—see also Transmission	
Sporadic E layer	227	line	
Square-prism resonator	222	attenuation	180, 181, 182, 186
Squegging oscillator	273	capacitance	179, 182, 183
Stacked loops	270	conductance	182, 183
Standard noise meter	245	impedance	180, 182
Standard time	27	inductance	179, 182, 183
Standing waves, acoustic	165	leakance	179, 180
Static—see Atmospheric noise		noise	190
Stub, open, shorted, impedance match-		phase shift	182
ing	199	propagation	180
Studio acoustics	165	resistance	179, 180, 182, 183
Sunspot cycle	229, 230	spacing	180
Superposition, principle	74	velocity	180
Suppressor grid	128	wavelength	180
Surface waves—see Attenuation, Field		Telephone toll cable	182-184
intensity, Propagation		Telephone transmission-line data	179-184
Surge impedance—see Transmission-line		Temperature	
impedance		extremes	23
Susceptance	68	highest	23
Symbols		humidity	20
chemical	19	lowest	23
elements	19	measurement, thermocouple	46, 47
Greek	15	metals	43
tubes	127	reactor	123
Symmetrical		rise, tube	131
attenuator	106	transformer	123
H attenuator	108	world	23
O attenuator	106, 110	TEM waves	207
Pi attenuator	106, 110	Terminals, winding	123
T attenuator	108	Terminology, tube	128, 129
trapezoid wave	282	TE waves	207
T		Theorems	
Tables, mathematical	304-323	Maclaurin's	297
Tangents, hyperbolic	318	network	74
T antennas	224	reciprocity	74
Tapping hole, screws	39	superposition	74
Taylor's theorem	297	Taylor's	297
Telegraph		Thevenin's	74
carrier systems	187	Thermal agitation	244, 246, 248
codes, comparison	193	Thermal properties, insulating materials	40
facilities	192	Thermocouples	46, 47
printer	192	Thevenin's theorem	74
frequency	192	Thoriated-tungsten filament	132, 134
speed	192	Time belts, worldwide	27
systems	192	Time constant	92-98
speeds	192	filters	89
Telephone cable		Time, Greenwich central	27
attenuation	183, 184	Time interval, reflected signal	244
cut-off frequency	183, 184	Tin, solder melting point	47
distributed constants	182, 184	TM waves	207
		Toll cable	182
		Torque vs horsepower	51

T pad	114	Transmission continued	
Transconductance	128	4-wire line	197*
Transfer characteristic	129	length	205
Transformation, conversion factors	11	miscellaneous	197
tee-pi	86	mismatch	198
wye-delta	86	noise	189
Transformers		parallel, impedance	197
audio	122	resistance	206
auto	122	shielded balanced, impedance	196
cores	123	shielded, impedance	197
design	124	stub	199
driver	122	surge impedance	195
filament	122	u-h-f attenuation	204
humidity	123	2 open wire, impedance	196
input	122	modulation types	32
interstage	122	speed, telegraph	192
iron-core	122-126	tolerances, frequency	30
major types	122	wave guides	207
modulation	122	Transverse electromagnetic waves	207
output	122	Trapezoidal rule	293
plate	122	Trapezoid, area	291
power supply	122	Trapezoid wave	282, 283
pressure	123	Triangle, area	291
protective gaps	123	Triangles, trigonometric solution	298
Scott	122	Trigonometry	
temperature	123	formulas	294-296
Transients	92-98	functions, logarithmic	206, 310-313
Transmission, Transmitters—see also At-		functions, natural	306-309
tenuation, Field intensity, Propaga-		solution, triangles	298
tion		spherical	240
codes	193	Triode perveance	129
frequency bands	32	Triode plate current	129
frequency, printer	192	Tropical, finishes and materials	50
frequency tolerances	30	T-section attenuators	100
line—see also Telephone line		Tubes, gaseous and vacuum	127-141
Army-Navy standard	201	amplification factor	127, 129
attenuation	204	amplifiers	143-164
attenuation, mismatch	198	cathode ray	136-141
balanced, impedance	196	accelerating electrode	137
beaded, impedance	196	anode	137
coaxial, impedance	196	application	139
constants	99, 179	brightness	139
open-wire pairs	179	characteristics	138, 139
toll cable	182	control	138
toll entrance cable	182	electrode	136
coupled sections	200	cut-off voltage	138
formulas	194	deflection factor	138
ground, impedance	197	deflection plates	137
impedance	180, 194	deflection potential	139
balanced line	196	deflection sensitivity	139
beaded line	196	electrodes	136, 137
coaxial	196	arrangement	137
matching stub	199	electron velocity	140, 141
open stub	199	electrostatic deflection	138, 139, 140
open 2-wire	196	focusing	138, 139
parallel wires	197	electrode	137
shorted stub	199	formulas	139, 140, 141
telephone cable	183, 184	grid voltage	139
telephone line	180, 182	intensifier electrode	137
wire to ground	197	magnetic deflection	138, 140, 141
wire to shield	197	modulating electrode	136
2 wires to ground	197	modulation	138

Tubes, gaseous and vacuum—Volume

Tubes *continued*

post-accelerating electrode	137
preaccelerating electrode	137
screen grid	137
shielding	139
spot size	139
types	142
clipper	142
coefficients	127, 128
composite diode lines	129
constant current characteristics	129
control grid	128
converters	142
cooling	131
critical grid voltage	129
diodes	142
plate current	129
electron inertia	135
electrode characteristic	129
electrode dissipation	131
emission	128, 133
filament	
characteristics	132-134
life	133
reactivation	134
voltage	133, 142
forced-air cooling	131
formulas	129
gas	142
switching	142
grid control	142
indicators	142
Klystrons	135
magnetrons	134, 135, 136
mutual conductance	129
negative-grid	134, 135
nomenclature	127
oxide-coated cathode	132
pentodes	142
performance limitations	130
perveance	129
phototubes	142
plate resistance	128
positive-grid	134, 135
power	142
preferred list	142
primary emission	128
pulse modulators	142
radiation cooling	131
receiving	142
rectifiers	142
screen grid	128
secondary emission	128
space-charge grid	128
suppressor grid	128
terminology	128
tetrodes	142
thoriated tungsten filament	132, 134
total emission	128
transconductance	128
transfer characteristic	129
transmitting	142

Tubes *continued*

triodes	142
plate current	129
tungsten filament	132
twin tetrodes	142
twin triodes	142
uhf	134
variational plate resistance	128
velocity-modulated	134, 135
voltage regulators	142
water cooling	131
Tuned circuits	
optimum coupling	79
parallel, dynamic resistance	76
selectivity	80
series, resonant frequency	75
Tungsten filament	132
Turnstile antenna, radiation pattern	264
Two-hop transmission	228, 229
Two-wire, open, copper line	206
impedance	196

U

Ultra high frequency	
electron inertia	135
lines, attenuation	204
transmission lines—see Transmission lines	
tubes	134-135
Unbalanced Pi attenuator	106
Unbalanced T attenuator	106
Units, conversion	11, 16, 17
Unsymmetrical trapezoid	283

V

Vacuum tubes—see Tubes	
van der Pol oscillator	273
Variational plate resistance	128
Velocity	
light	28
modulated tubes	135
telephone cable	183, 184
telephone lines	180
transmission line	194
variation—see Velocity modulation	
wind	42
Vertically polarized waves	240
Vertical radiators	254-258
Very-short-waves, propagation	231-234
V-H-F propagation	231-234
path length	232
Voice-frequency carrier	187
Voltage, gap breakdown	48
Voltage, ratio to decibels	34
Voltage regulators	142
Volume	
cone	293
cylinder	293
music	174
pyramid	293

Volume continued		Wave, integrated	274
speech	174	Wavelength-frequency	
sphere	293	chart	29
W		classifications	28
Washers, screws	39	conversion	29
Water		formulas	29
cooling, tube	131	spectrum	28
discharge rate	49	telephone cable	183, 184
head in feet	49	telephone lines	180
resistance through pipes	49	transmission line	194
Wave analysis	281	Wave propagation—see Propagation	
clipped sawtooth	284	Wave shaping	274
critically damped exponential	287	Weather data	23, 42
Fourier	277	Weights, atomic	19
full-wave rectified	287	Wet-bulb thermometer	20
isosceles triangle	283	Winding terminals	123
rectangular	282	Wind velocities and pressures	42
sawtooth	284, 285	Wire	
sine	285, 286	American gauge	35
symmetrical trapezoid	282	copper	35, 36, 37, 38, 60
unsymmetrical trapezoid	283	sizes, loudspeaker	171
Wave-filter reactors	123	spacing, telephone lines	180
Wave forms		transmission	179–193
analysis	281	World, distances	240
Fourier analysis	277–287	World time chart	27
nonsinusoidal	272–287	Wye-delta transformation	86
shaping	274	X	
Wave guides and resonators	207–223	X-rays	28
attenuation	216	Y	
circular	213–217	Y-delta transformation	86
cut-off wavelength	216		
horns	217		
rectangular	208		