

Ceramic Filters (CERAFIL®)/Ceramic Discriminators for Communications Equipment



CERAFIL® kHz SMD Type CFXCE Series

CFXCE series are very small and high-efficiency surface mount, ladder type 450/455 kHz ceramic filters "CERAFIL" for IF section.

Compared to our previous compact surface mounted 6-element product, this ceramic filter has been significantly downsized to approximately one-third the original volume and reduced to less than 2mm in height.

As for electrical performance, this product, which consists of 4 elements, provides stop band attenuation equivalent to that of our previous 6-element product. The input/output impedance characteristics are also equivalent to those of the previous product, and spurious responses in the vicinity of the passing band can now be eliminated. This allows mobile telecommunications equipment manufacturers to easily design the periphery of the IF section and thus greatly enhance the interference suppression capability of the equipment. In addition, this ceramic filter provides flatter group delay time characteristics than the previous product, and will effectively work as a component for data transmission in digital mobile telecommunications systems.

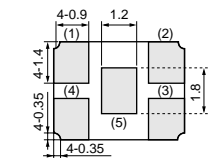
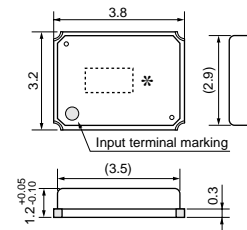

(1) : Input
(2) : Output
(3)(4)(5) : Ground
Tolerance unless otherwise specified : ±0.1
() : Reference
(in mm)

■ Features

1. Compact, thin, and lightweight
Size: 3.8x3.2x1.25mm
Weight: 40mg
2. Out-of-band attenuation is increased and spurious responses are greatly decreased.
3. Group delay time characteristics are flattened.
4. Surface mountable, and reflow soldering can be used for mounting. Available lead (Pb) free solder reflow

■ Applications

1. IF filters for PDCs
2. IF filters for various types of pagers
3. IF filters for various types of analog and digital cellular telephones
4. IF filters for radio communication circuits applicable for PDA or PCMCIA
5. IF filters for other general mobile wireless equipment

Part Number	Nominal Center Frequency (fn) (kHz)	3dB Bandwidth (kHz)	6dB Bandwidth	Stop Bandwidth (kHz)	Stop Band Attenuation (dB)	Stop Band Att.(2) (dB)	Stop Band Att.(3) (dB)	Insertion Loss (dB)	Ripple (dB)	GDT Deviation (μs)
CFXCE450KCFA-R1	450	fn±9.0 to ±12.0kHz max.	-	fn±35.0 max. [within 50dB]	30 min. [at fn±25kHz]	55 min. [within fn±40kHz to ±50kHz]	47 min. [within fn±100kHz]	6.0 max. [at fn]	0.5 max. [within fn±10.5kHz]	27.0 max. [within fn±10.5kHz]

Spurious:40dB [within 0.1 to 1.0MHz]

Input/Output Impedance: 2000 ohm

For safety purposes, connect the output of filters to the IF amplifier through a D.C. blocking capacitor. Avoid applying a direct current to the output of ceramic filters.

The order quantity should be an integral multiple of the "Minimum Quantity" shown in package page in this catalog.

■ Test Circuit

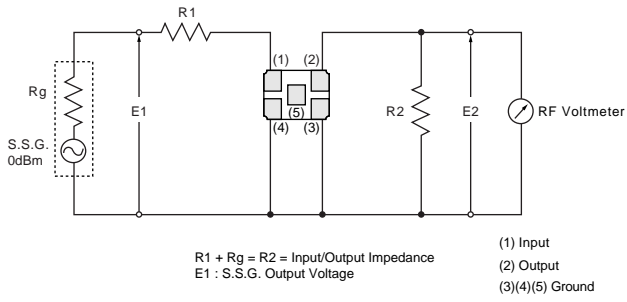

■ Frequency Characteristics

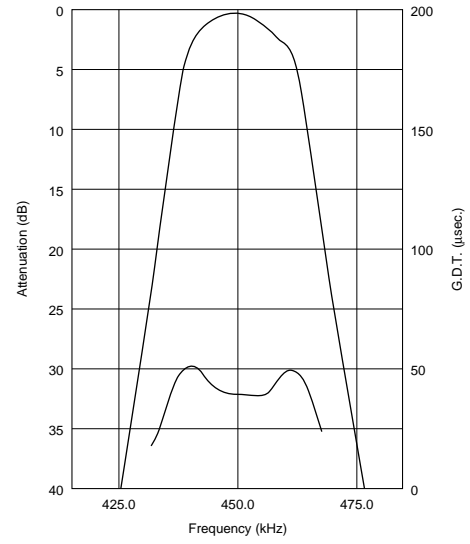

Ceramic Filters (CERAFIL®)/Ceramic Discriminators for Communications Equipment



CERAFIL® kHz SMD Type SFPKA Series

The SFPKA series is comprised of small, high performance, economical, thin (5.0mm) filters consisting of 4 ceramic elements.

Their innovative construction is perfect for shrinking mobile communication products such as cordless phones, pager and transceivers.

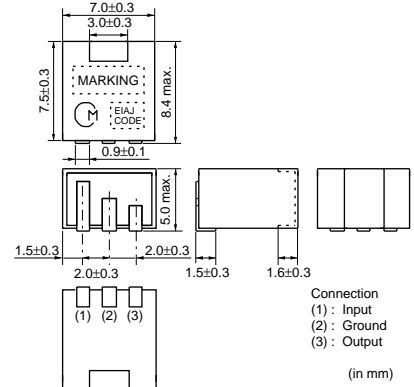

■ Features

1. The filters are mountable by automatic placers.
2. The filters can be reflow soldered and withstand washing.
3. They are slim, at only 5.0mm maximum thickness.
4. The bandwidth ranges from D to H.
5. Operating temperature range: -20 to +80 (degree C)
Storage temperature range: -40 to +85 (degree C)

Part Number	Center Frequency (fo) (kHz)	6dB Bandwidth (kHz)	Stop Bandwidth (kHz)	Stop Band Attenuation (dB)	Insertion Loss (dB)	Ripple (dB)	Input/Output Impedance (ohm)
SFPKA455KD4A-R1	455.0 ±1.5kHz	fn±10.0 min.	fn±20.0 max. [within 40dB]	27 min. [within fn±100kHz]	4.0 max. [at minimum loss point]	2.0 max. [within fn±7kHz]	1500
SFPKA455KE4A-R1	455.0 ±1.5kHz	fn±7.5 min.	fn±15.0 max. [within 40dB]	27 min. [within fn±100kHz]	6.0 max. [at minimum loss point]	1.5 max. [within fn±5kHz]	1500
SFPKA455KF4A-R1	455.0 ±1.5kHz	fn±6.0 min.	fn±12.5 max. [within 40dB]	27 min. [within fn±100kHz]	6.0 max. [at minimum loss point]	1.5 max. [within fn±4kHz]	1500
SFPKA455KG1A-R1	455.0 ±1.0kHz	fn±4.5 min.	fn±10.0 max. [within 40dB]	25 min. [within fn±100kHz]	6.0 max. [at minimum loss point]	1.5 max. [within fn±3kHz]	1500
SFPKA455KH1A-R1	455.0 ±1.0kHz	fn±3.0 min.	fn±9.0 max. [within 40dB]	35 min. [within fn±100kHz]	6.0 max. [at minimum loss point]	1.5 max. [within fn±2kHz]	2000

Center frequency (fo) defined by the center of 6dB bandwidth.
(fn) means nominal center frequency 455kHz.

For safety purposes, connect the output of filters to the IF amplifier through a D.C. blocking capacitor. Avoid applying a direct current to the output of ceramic filters.
The order quantity should be an integral multiple of the "Minimum Quantity" shown in package page in this catalog.

■ Test Circuit

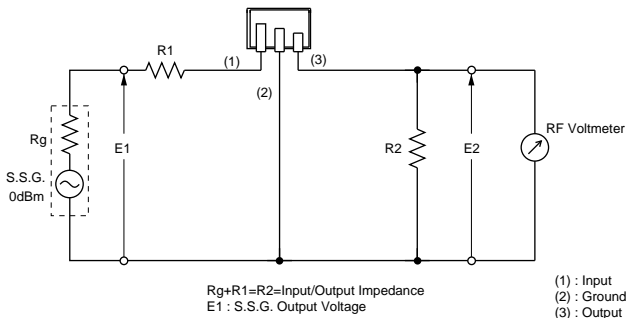

■ Frequency Characteristics

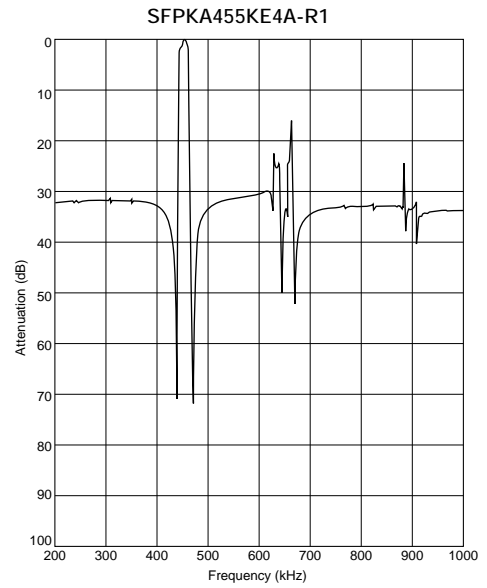
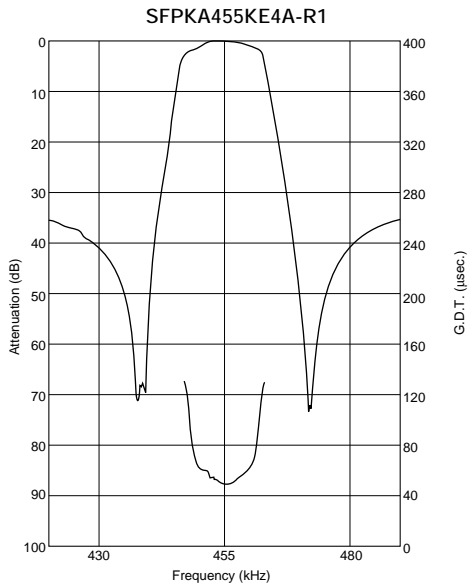

Ceramic Filters (CERAFIL®)/Ceramic Discriminators for Communications Equipment



CERAFIL® kHz SMD Type CFUKG Series

3

The CFUKG series is comprised of small, high performance, thin (4.0mm) filters consisting of 4 ceramic elements. Their innovative construction is perfect for shrinking mobile communication products such as pocket pagers and cellular phones.

■ Features

1. The filters are mountable by automatic placers.
2. The filters can be reflow soldered and withstand washing.
3. They are slim, at only 4.0mm maximum thickness, and have a small mounting area (7.5x6.0mm) enabling flexible PCB design.
4. The bandwidth ranges from D to G.
5. Operating temperature range: -20 to +80 (degree C)
Storage temperature range: -40 to +85 (degree C)

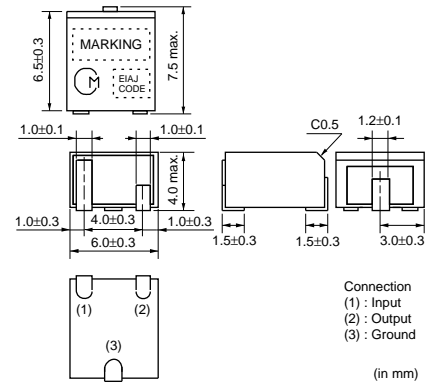

Part Number	Center Frequency (fo) (kHz)	6dB Bandwidth (kHz)	Stop Bandwidth (kHz)	Stop Band Attenuation (dB)	Insertion Loss (dB)	Ripple (dB)	Input/Output Impedance (ohm)
CFUKG455KD4A-R0	455.0 ±1.5kHz	fn±10.0 min.	fn±20.0 max. [within 40dB]	27 min. [within fn±100kHz]	4.0 max. [at minimum loss point]	2.0 max. [within fn±7kHz]	1500
CFUKG455KE4A-R0	455.0 ±1.5kHz	fn±7.5 min.	fn±15.0 max. [within 40dB]	27 min. [within fn±100kHz]	6.0 max. [at minimum loss point]	1.5 max. [within fn±5kHz]	1500
CFUKG455KF4A-R0	455.0 ±1.5kHz	fn±6.0 min.	fn±12.5 max. [within 40dB]	27 min. [within fn±100kHz]	6.0 max. [at minimum loss point]	1.5 max. [within fn±4kHz]	1500
CFUKG455KG1A-R0	455.0 ±1.0kHz	fn±4.5 min.	fn±10.0 max. [within 40dB]	25 min. [within fn±100kHz]	6.0 max. [at minimum loss point]	1.5 max. [within fn±3kHz]	1500

Center frequency (fo) defined by the center of 6dB bandwidth.
(fn) means nominal center frequency 455kHz.

For safety purposes, connect the output of filters to the IF amplifier through a D.C. blocking capacitor. Avoid applying a direct current to the output of ceramic filters. The order quantity should be an integral multiple of the "Minimum Quantity" shown in package page in this catalog.

■ Test Circuit

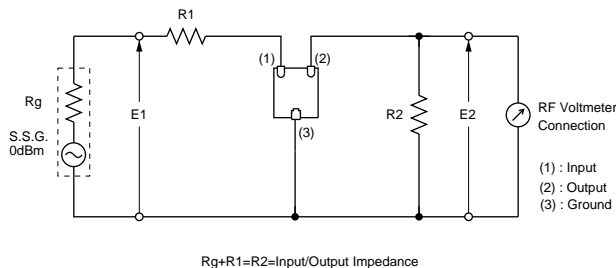

■ Frequency Characteristics

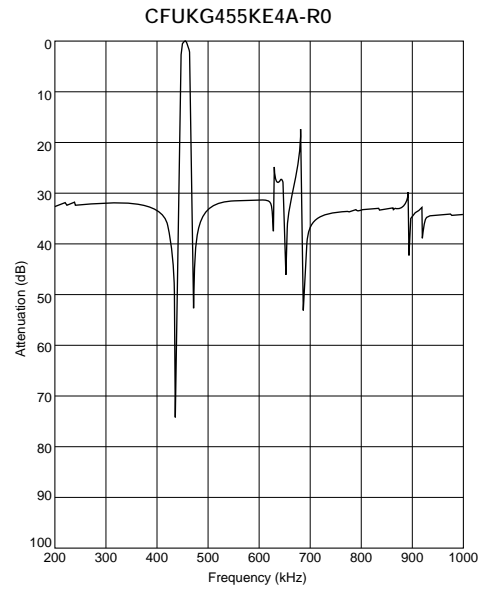
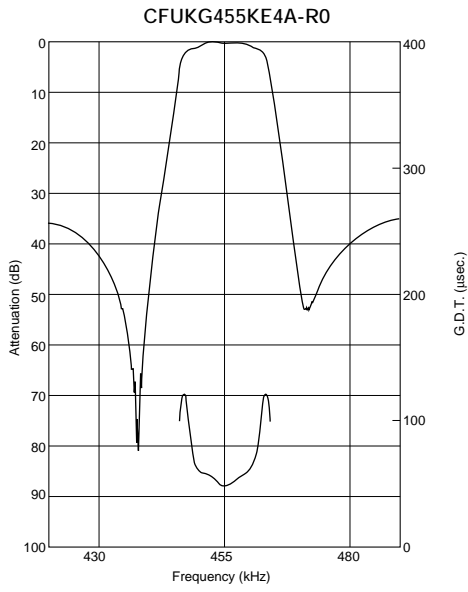

3

Ceramic Filters (CERAFIL®)/Ceramic Discriminators for Communications Equipment



CERAFIL® kHz SMD Type CFUKG_X Series

The CFUKG_X series is comprised of small, high performance, thin (4.0mm) filters consisting of 4 ceramic elements. The filters exhibit an extremely flat GDT characteristic combined with a narrow bandwidth. The filters are recommended for narrow band digital communication applications.

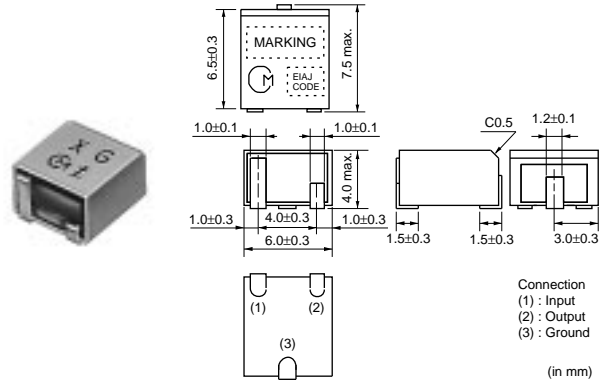

■ Features

1. The filters are mountable by automatic placers.
2. The filters can be reflow soldered and withstand washing.
3. They are slim, at only 4.0mm maximum thickness, and have a small mounting area (7.5x6.0mm) enabling flexible PCB design.
4. The bandwidth ranges from E to H.
5. Operating temperature range: -20 to +80 (degree C)
Storage temperature range: -40 to +85 (degree C)

Part Number	Center Frequency (fo) (kHz)	6dB Bandwidth (kHz)	Stop Bandwidth (kHz)	Stop Band Attenuation (dB)	Insertion Loss (dB)	Ripple (dB)	GDT Deviation (μs)	Input/Output Impedance (ohm)
CFUKG455KE4X-R0	455.0 ±1.5kHz	fn±7.5 min.	fn±17.5 max. [within 40dB]	27 min. [within fn±100kHz]	6.0 max. [at minimum loss point]	1.0 max. [within fn±5kHz]	25.0 max. [within fn±5kHz]	1500
CFUKG455KF4X-R0	455.0 ±1.5kHz	fn±6.0 min.	fn±15.0 max. [within 40dB]	27 min. [within fn±100kHz]	6.0 max. [at minimum loss point]	1.0 max. [within fn±4kHz]	25.0 max. [within fn±4kHz]	1500
CFUKG455KG1X-R0	455.0 ±1.0kHz	fn±4.5 min.	fn±12.5 max. [within 40dB]	25 min. [within fn±100kHz]	6.0 max. [at minimum loss point]	1.0 max. [within fn±3kHz]	25.0 max. [within fn±3kHz]	1500
CFUKG455KH1X-R0	455.0 ±1.0kHz	fn±3.0 min.	fn±10.0 max. [within 40dB]	25 min. [within fn±100kHz]	7.0 max. [at minimum loss point]	1.0 max. [within fn±2kHz]	25.0 max. [within fn±2kHz]	1500

Center frequency (fo) defined by the center of 6dB bandwidth.
(fn) means nominal center frequency 455kHz.

For safety purposes, connect the output of filters to the IF amplifier through a D.C. blocking capacitor. Avoid applying a direct current to the output of ceramic filters. The order quantity should be an integral multiple of the "Minimum Quantity" shown in package page in this catalog.

■ Test Circuit

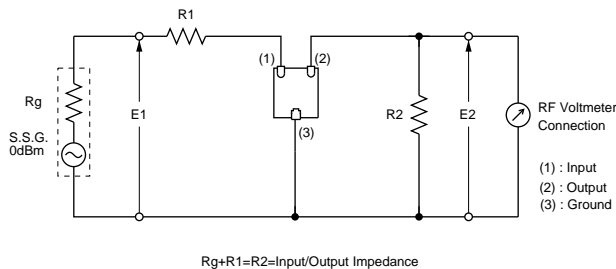

■ Frequency Characteristics

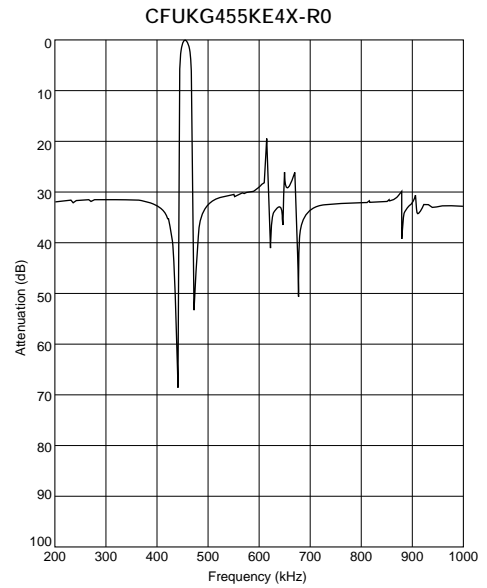
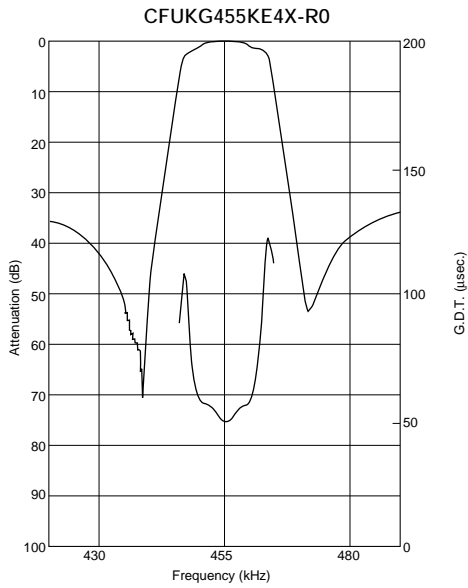

Ceramic Filters (CERAFIL[®])/Ceramic Discriminators for Communications Equipment



CERAFIL[®] kHz SMD Type CFUKF Series

The CFUKF series is comprised of small, high performance, thin (4.0mm) filters consisting of 4 ceramic elements. The filters exhibit an extremely flat GDT characteristic. The filters are recommended for digital communication applications and are perfect in hand held cellular phones, etc.

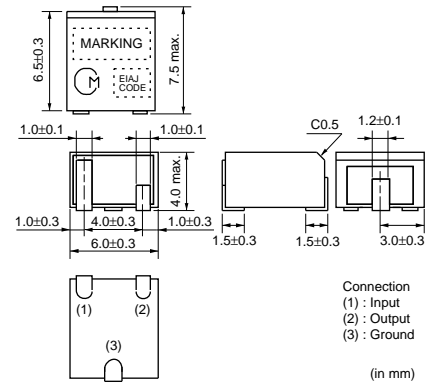

■ Features

1. The filters are mountable by automatic placers.
2. The filters can be reflow soldered and withstand washing.
3. They are slim, at only 4.0mm maximum thickness, and have a small mounting area (7.5x6.0mm) enabling flexible PCB design.
4. The bandwidth ranges from A to E.
5. Operating temperature range: -20 to +80 (degree C)
Storage temperature range: -40 to +85 (degree C)

Part Number	Center Frequency (fo) (kHz)	6dB Bandwidth (kHz)	Stop Bandwidth (kHz)	Stop Band Attenuation (dB)	Insertion Loss (dB)	Ripple (dB)	GDT Deviation (μs)	Input/Output Impedance (ohm)
CFUKF455KA2X-R0	455.0 ±2.0kHz	fn±17.5 min.	fn±40.0 max. [within 40dB]	25 min. [within fn±100kHz]	4.0 max. [at minimum loss point]	1.0 max. [within fn±12kHz]	15.0 max. [within fn±12kHz]	1000
CFUKF455KB4X-R0	455.0 ±1.5kHz	fn±15.0 min.	fn±35.0 max. [within 40dB]	25 min. [within fn±100kHz]	5.0 max. [at minimum loss point]	1.0 max. [within fn±10kHz]	15.0 max. [within fn±10kHz]	1000
CFUKF455KC4X-R0	455.0 ±1.5kHz	fn±12.5 min.	fn±30.0 max. [within 40dB]	25 min. [within fn±100kHz]	6.0 max. [at minimum loss point]	1.0 max. [within fn±8kHz]	15.0 max. [within fn±8kHz]	1000
CFUKF455KD1X-R0	455.0 ±1.0kHz	fn±10.0 min.	fn±25.0 max. [within 40dB]	23 min. [within fn±100kHz]	7.0 max. [at minimum loss point]	1.0 max. [within fn±7kHz]	20.0 max. [within fn±7kHz]	1500
CFUKF455KE1X-R0	455.0 ±1.0kHz	fn±7.5 min.	fn±20.0 max. [within 40dB]	23 min. [within fn±100kHz]	8.0 max. [at minimum loss point]	1.0 max. [within fn±5kHz]	20.0 max. [within fn±5kHz]	1500

Center frequency (fo) defined by the center of 6dB bandwidth.
(fn) means nominal center frequency 455kHz.

For safety purposes, connect the output of filters to the IF amplifier through a D.C. blocking capacitor. Avoid applying a direct current to the output of ceramic filters. The order quantity should be an integral multiple of the "Minimum Quantity" shown in package page in this catalog.

■ Test Circuit

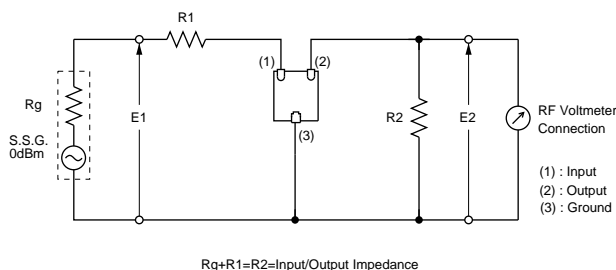

■ Frequency Characteristics

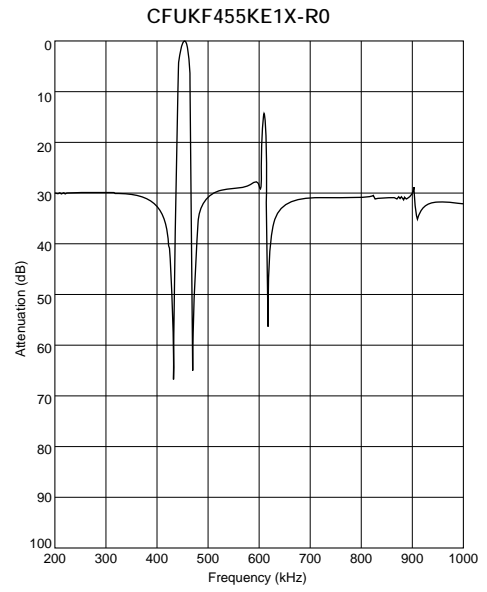
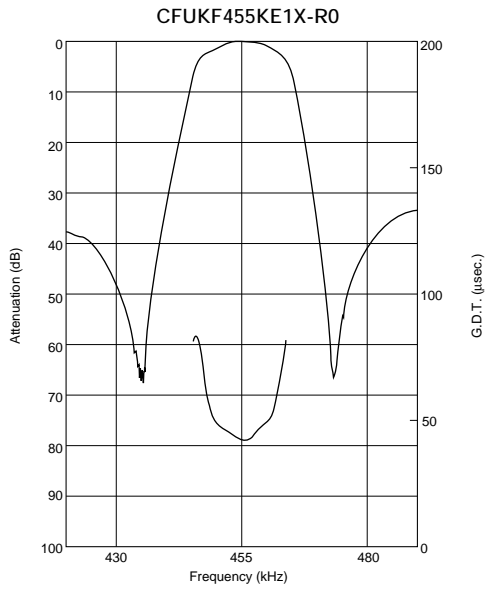

5

Ceramic Filters (CERAFIL[®])/Ceramic Discriminators for Communications Equipment



CERAFIL[®] kHz SMD Type CFWKA Series

The CFWKA series is comprised of small, high performance, thin (3.0mm) filters consisting of 6 ceramic elements. The filters are recommend for pager or hand held cellular phones.

■ Features

1. The filters are mountable by automatic placers.
2. The filters can be reflow soldered.
3. They are slim, at only 3.0mm maximum thickness.
4. The filters are wide bandwidth, flat GDT within pass band.
5. Operating temperature range: -20 to +80 (degree C)
Storage temperature range: -40 to +85 (degree C)

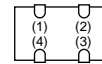
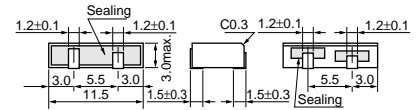
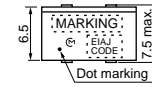

(1): Input
(2): Output
(3)(4): Ground
(Tolerance ±0.3mm in mm)

6

Part Number	Nominal Center Frequency (fn) (kHz)	3dB Bandwidth (kHz)	6dB Bandwidth (kHz)	Stop Bandwidth (kHz)	Stop Band Attenuation (dB)	Stop Band Att.(2) (dB)	Insertion Loss (dB)	Ripple (dB)	Input/Output Impedance (ohm)
CFWKA450K DFA-R0	450	-	fn±10.0 min.	fn±20.0 max. [within 50dB]	50 min. [within fn±100kHz]	-	4.0 max. [at minimum loss point]	3.0 max. [within fn±7kHz]	1500
CFWKA450KEFA-R0	450	-	fn±7.5 min.	fn±15.0 max. [within 50dB]	50 min. [within fn±100kHz]	-	6.0 max. [at minimum loss point]	3.0 max. [within fn±5kHz]	1500
CFWKA450KEFA001-R0	450	fn±6.5 min.	-	fn±15.0 max. [within 50dB]	55 min. [fn±18 to ±33kHz]	50 min. [within fn±100kHz]	4.0 max. [at fn]	3.0 max. [within fn±6.5kHz]	1500
CFWKA450KFFA-R0	450	-	fn±6.0 min.	fn±12.5 min. [within 50dB]	50 min. [within fn±100kHz]	-	6.0 max. [at minimum loss point]	3.0 max. [within fn±4kHz]	1500
CFWKA450KGF A-R0	450	-	fn±4.5 min.	fn±11.0 max. [within 50dB]	50 min. [within fn±100kHz]	-	6.0 max. [at minimum loss point]	2.0 max. [within fn±3kHz]	1500

For safety purposes, connect the output of filters to the IF amplifier through a D.C. blocking capacitor. Avoid applying a direct current to the output of ceramic filters. The order quantity should be an integral multiple of the "Minimum Quantity" shown in package page in this catalog.

■ Test Circuit

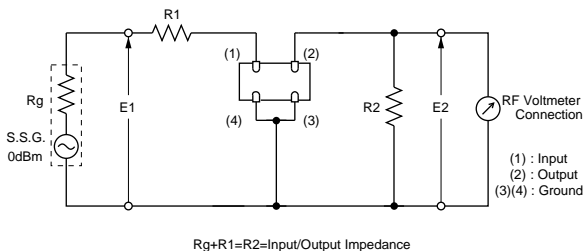

■ Frequency Characteristics

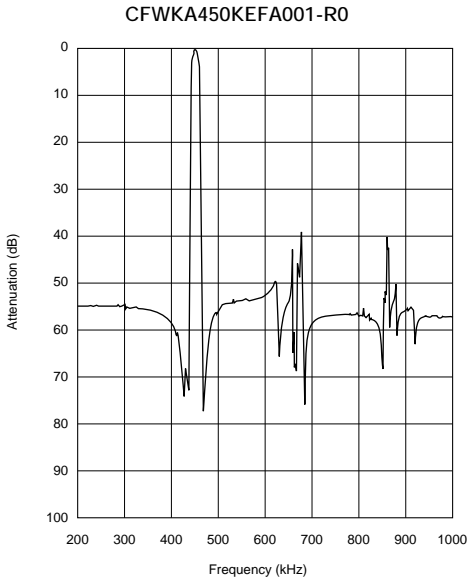
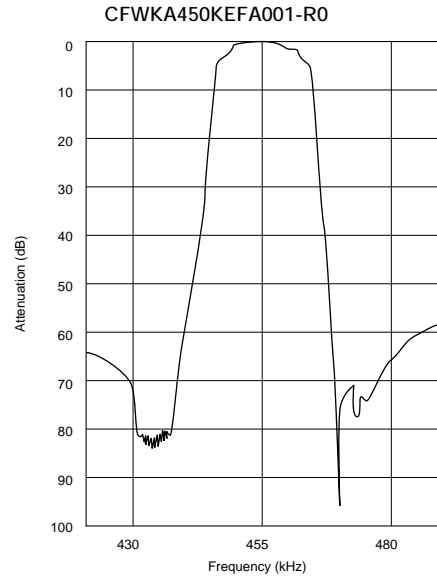
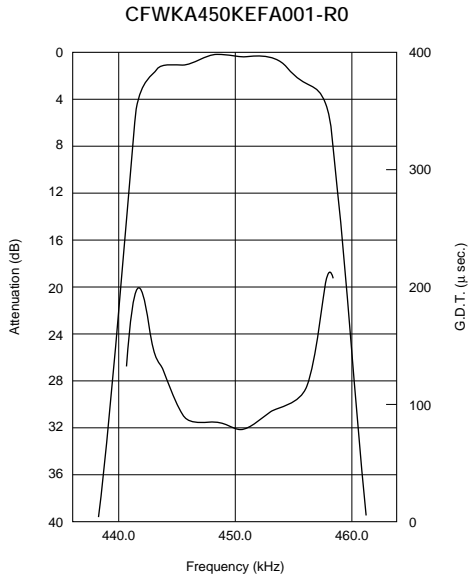

Ceramic Filters (CERAFIL®)/Ceramic Discriminators for Communications Equipment



CERAFIL® kHz SMD Type CFWKA_Y Series

The CFWKA_Y series is comprised of small, high performance, thin (3.0mm) filters consisting of 6 ceramic elements. The filters are recommend for digital communication applications and are perfect in hand held cellular phones.

■ Features

1. The filters are mountable by automatic placers, and can be reflow soldered.
2. They are slim, at only 3.0mm maximum thickness.
3. The filters are wide bandwidth, flat GDT within pass band.
4. Operating temperature range: -20 to +80 (degree C)
Storage temperature range: -40 to +85 (degree C)

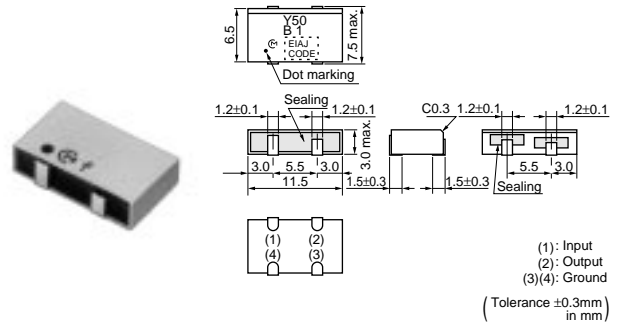

Part Number	Nominal Center Frequency (fn) (kHz)	3dB Bandwidth (kHz)	6dB Bandwidth (kHz)	Stop Bandwidth (kHz)	Stop Band Attenuation (dB)	Insertion Loss (dB)	Spurious Response (dB)	GDT Deviation (μs)	Input/Output Impedance (ohm)
CFWKA450KBFY001-R0	450	$f_n \pm 11.5$ min.	$f_n \pm 13.0$ min.	$f_n \pm 30.0$ max. [within 50dB]	45 min. [within $f_n \pm 100$ kHz]	4.0 max. [at minimum loss point]	20 min. [within 0.1 to 1.0MHz]	30.0 max. [within $f_n \pm 10$ kHz]	1000

For safety purposes, connect the output of filters to the IF amplifier through a D.C. blocking capacitor. Avoid applying a direct current to the output of ceramic filters. The order quantity should be an integral multiple of the "Minimum Quantity" shown in package page in this catalog.

■ Test Circuit

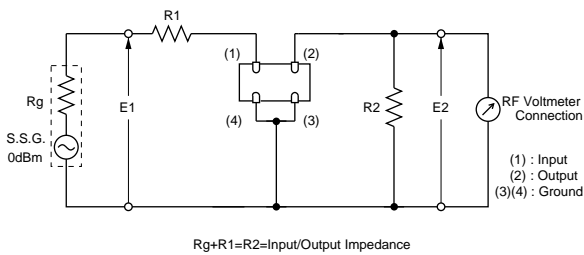

■ Frequency Characteristics

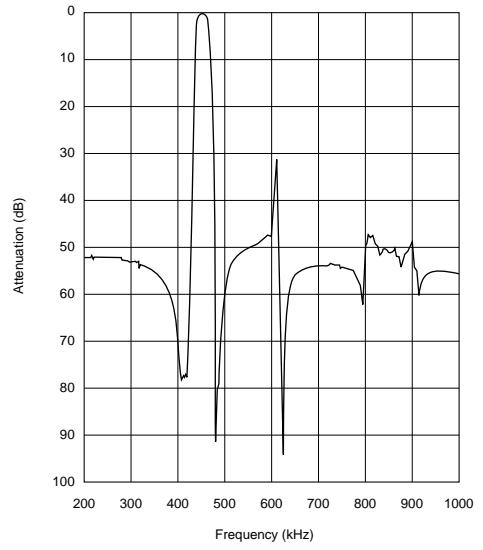
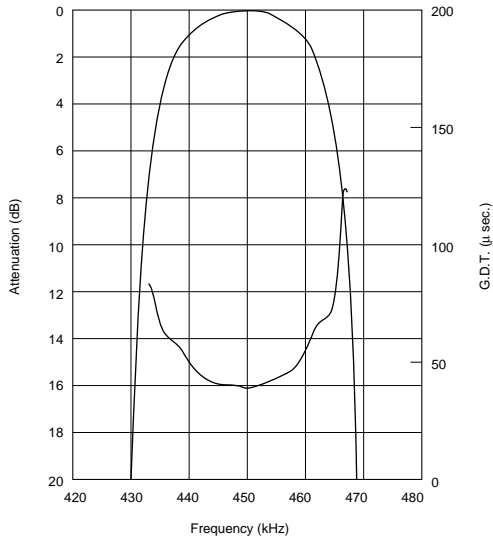

Ceramic Filters (CERAFIL®)/Ceramic Discriminators for Communications Equipment



CERAFIL® MHz SMD Type SF ECS10M8 Series

The SF ECS10M8 series are small, high performance and super thin (1.5mm max.) filters. Piezoelectric element is connected in the sandwich shape by heat resistant substrate.

The filters exhibit flat GDT characteristic in pass band.

The filters are recommended for digital communication applications and are perfect in hand held cellular phones, pocket cordless phones, etc.

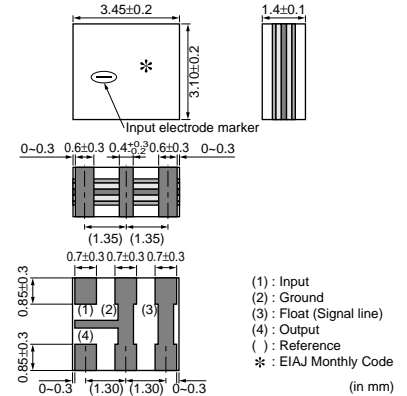
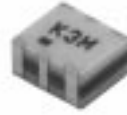

■ Features

1. The filters are mountable by automatic placers.
2. They are slim, at only 1.5mm max. thickness, and have a small mounting area (3.45x3.1mm) enabling flexible PCB design.
3. Types with 10.7/10.75/10.8MHz of center frequency are available.
4. Operating temperature range: -10 to +50 (degree C)
Storage temperature range: -40 to +85 (degree C)

Part Number	Nominal Center Frequency (fn) (MHz)	3dB Bandwidth (kHz)	Stop Bandwidth (kHz)	Insertion Loss (dB)	Ripple (dB)	Spurious Response (dB)	GDT Deviation (μs)	Absolute GDT (μs)	Input/Output Impedance (ohm)
SF ECS10M8PF00-R0	10.800	fn±110 min.	fn±310 max. [within 20dB]	6.0 max. [at fn]	0.5 max. [within fn±100kHz]	-	1.5 max. [within fn±100kHz]	2.8 ±1.0μs [at fn]	330
SF ECS10M8RF00-R0	10.800	fn±135 min.	fn±350 max. [within 20dB]	6.0 max. [at fn]	0.5 max. [within fn±100kHz]	-	1.2 max. [within fn±100kHz]	2.6 ±1.0μs [at fn]	330
SF ECS10M8SF00-R0	10.800	fn±150 min.	fn±420 max. [within 20dB]	5.0 max. [at fn]	1.0 max. [within fn±110kHz]	25 min. [within 9 to 12 MHz]	1.5 max. [within fn±110kHz]	-	330

For safety purposes, connect the output of filters to the IF amplifier through a D.C. blocking capacitor. Avoid applying a direct current to the output of ceramic filters. The order quantity should be an integral multiple of the "Minimum Quantity" shown in package page in this catalog.

■ Test Circuit

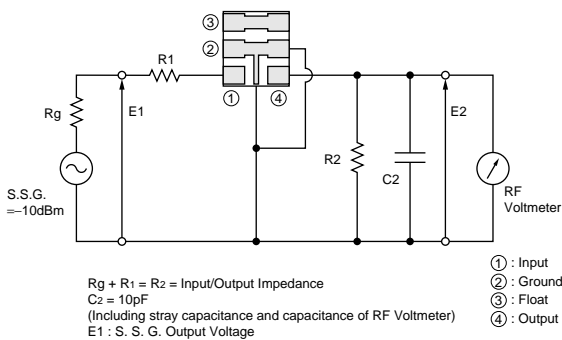

■ Frequency Characteristics

SF ECS10M8PF00-R0

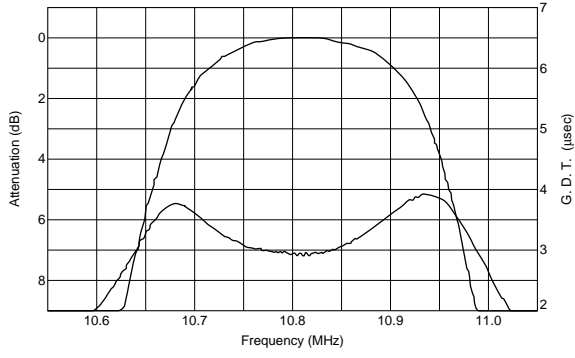

SF ECS10M8PF00-R0

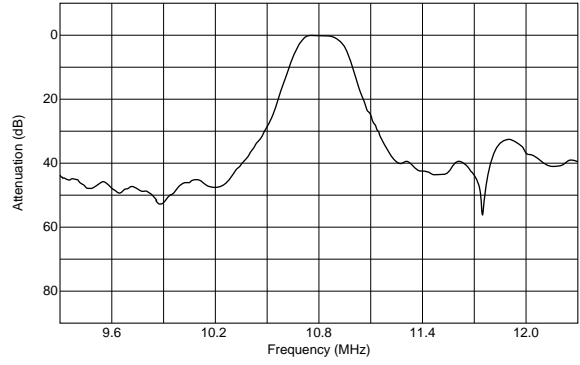

Ceramic Filters (CERAFIL®)/Ceramic Discriminators for Communications Equipment



CERAFIL® MHz SMD Type SFECF10M7 Series

SFECF10M7 series for FM-receivers are small, high performance and super thin (1.4mm max.) filters. Piezoelectric element is connected in the sandwich shape by ceramics substrate. They have 1.4mm max. thickness and small mounting area. (3.45x3.1mm)
SFECF series and CDSCB series (MHz Discriminator) enable customers to make VICS/RKE/TPMS set so thin and small sized.

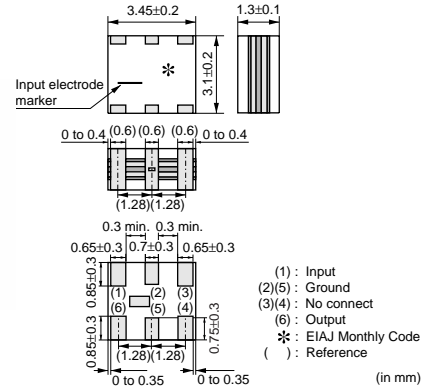

■ Features

1. The filters are mountable by automatic placers.
2. They are slim, at only 1.4mm max. thickness, and have a small mounting area (3.45x3.1mm) enabling flexible PCB design.
3. Various bandwidths are available. Select a suitable type in accordance with the desired selectivity.
4. Operating temperature range: -20 to +80 (degree C)
Storage temperature range: -40 to +85 (degree C)

Part Number	Center Frequency (fo) (MHz)	Nominal Center Frequency (fn) (MHz)	3dB Bandwidth (kHz)	Attenuation (kHz)	Insertion Loss (dB)	Ripple (dB)	Spurious Attenuation (dB)	Input/Output Impedance (ohm)
SFECF10M7HA00-R0	10.700 ±30kHz	-	180 ±40kHz	470 max.	4.0 ±2.0dB	1.0 max.	30 min.	330
SFECF10M7GA00-R0	10.700 ±30kHz	-	230 ±50kHz	510 max.	3.5 ±2.0dB	1.0 max.	30 min.	330
SFECF10M7FA00-R0	10.700 ±30kHz	-	280 ±50kHz	590 max.	3.0 ±2.0dB	1.0 max.	30 min.	330
SFECF10M7EA00-R0	10.700 ±30kHz	-	330 ±50kHz	700 max.	3.0 ±2.0dB	1.0 max.	30 min.	330
SFECF10M7DF00-R0	-	10.700	fn±150 min.	990 max.	6.0 max. [at fn]	3.0 max.	20 min.	330

Area of Attenuation: [within 20dB] Area of Spurious Attenuation: [within 9MHz to 12MHz]

Area of Insertion Loss: at minimum loss point Area of Ripple: within 3dB B.W.

Center frequency (fo) defined by center of 3dB bandwidth.

For safety purposes, connect the output of filters to the IF amplifier through a D.C. blocking capacitor. Avoid applying a direct current to the output of ceramic filters.

The order quantity should be an integral multiple of the "Minimum Quantity" shown in package page in this catalog.

■ Test Circuit

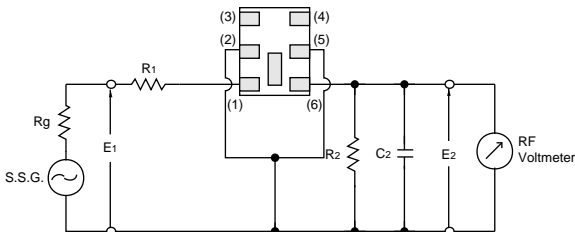

Rg = 50Ω R1 = 280Ω ±5% R2 = 330Ω ±5%
Cz = 10 ± 2 pF (Including stray capacitance and Input capacitance of RF Volt Meter)
E1 : S.S.G. Output Voltage

(1) : Input
(2)(5) : Ground
(3)(4) : No connect
(6) : Output

■ Frequency Characteristics

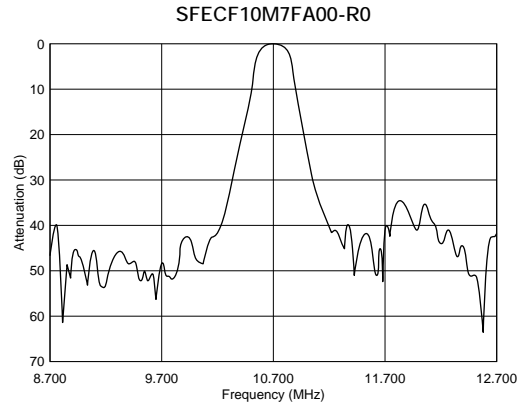
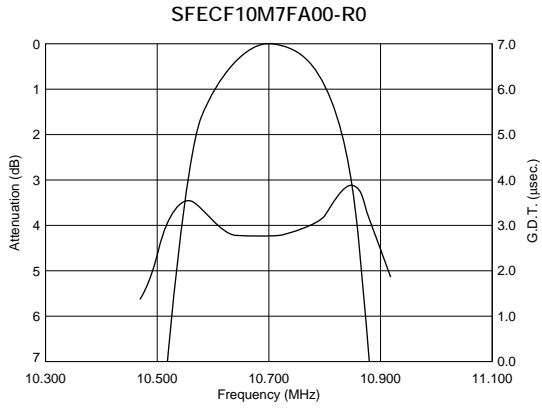

Ceramic Filters (CERAFIL®)/Ceramic Discriminators for Communications Equipment



CERAFIL® MHz SMD Type SFECD10M7 Series

SFECD10M7 series for FM-receivers are small, high performance and ultra thin (1.0mm max.) filters. Piezoelectric element is connected in the sandwich shape by very thin ceramics substrate. They have 1.0mm max. thickness and small mounting area. (3.45x3.1mm)
SFECD series enable customers to make RF modules so thin and small sized.

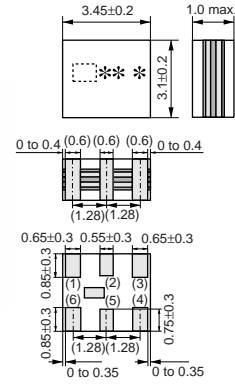

■ Features

1. The filters are mountable by automatic placers.
2. They are slim, at only 1.0mm max. thickness, and have a small mounting area (3.45x3.1mm) enabling flexible PCB design.
3. Operating temperature range: -20 to +80 (degree C)
Storage temperature range: -40 to +85 (degree C)

■ Applications

1. Card type radios
2. Card type RKE modules
3. Card type PHS modules

10

Part Number	Center Frequency (fo) (MHz)	Nominal Center Frequency (fn)	3dB Bandwidth (kHz)	Attenuation (kHz)	Insertion Loss (dB)	Ripple (dB)	Spurious Attenuation (dB)	Input/Output Impedance (ohm)
SFECD10M7FA00-R0	10.700 ±30kHz	-	280 ±50kHz	590 max.	3.0 ±2.0dB	1.0 max.	30 min.	330

Area of Attenuation: [within 20dB] Area of Spurious Attenuation: [within 9MHz to 12MHz]

Area of Insertion Loss: at minimum loss point Area of Ripple: within 3dB B.W.

Center frequency (fo) defined by center of 3dB bandwidth.

For safety purposes, connect the output of filters to the IF amplifier through a D.C. blocking capacitor. Avoid applying a direct current to the output of ceramic filters.

The order quantity should be an integral multiple of the "Minimum Quantity" shown in package page in this catalog.

■ Test Circuit

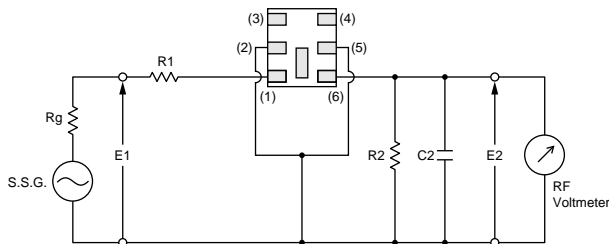

- (1) : Input
- (2)(5) : Ground
- (3)(4) : Float
- (6) : Output

R1+Rg=R2=330Ω±5%, Rg=50Ω
C2=10pF (Including stray capacitance and Input capacitance of RF Voltmeter)
E1 : S.S.G. Output Voltage

■ Frequency Characteristics

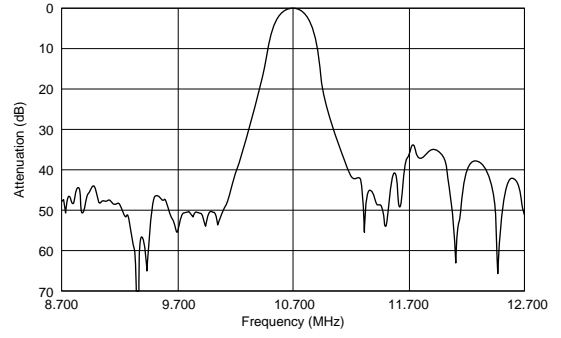
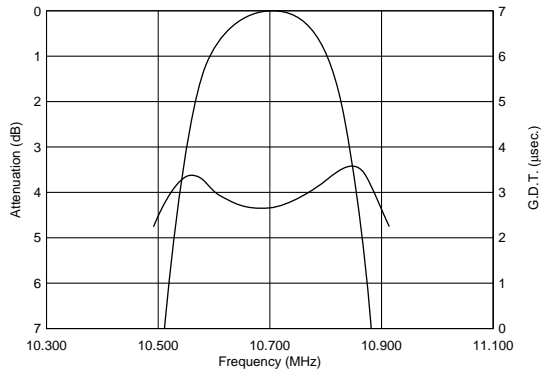

Ceramic Filters (CERAFIL®)/Ceramic Discriminators for Communications Equipment



CERAFIL® MHz SMD Type SFSCD20M0 Series

SFSCD series are chip surface mount filter, having center frequency 15 to 22 MHz and 3dB bandwidth 1.2 to 1.8MHz (at 20MHz).
(More than twice width compared with current types)
They have 1.0mm max. thickness and small mounting area. (4.5x3.8mm)

■ Features

1. The filters are mountable by automatic placers.
2. They are slim, at only 1.0mm max. thickness, and have a small mounting area (4.5x3.8mm) enabling flexible PCB design.
3. Available lead (Pb) free solder reflow.
4. Operating temperature range: -20 to +80 (degree C)
Storage temperature range: -40 to +85 (degree C)

■ Applications

1. GPS
2. Wireless audio

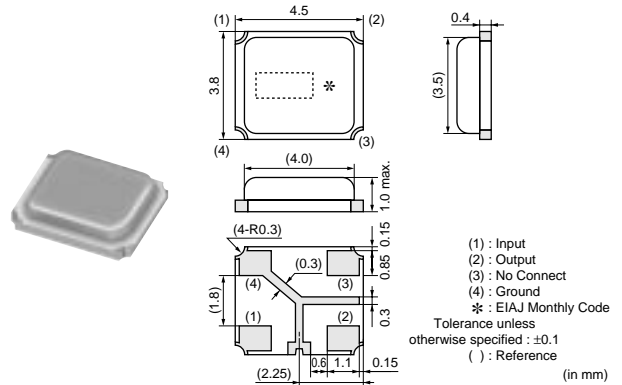

Part Number	Nominal Center Frequency (fn) (MHz)	3dB Bandwidth (kHz)	Stop Bandwidth (MHz)	Insertion Loss (dB)	Ripple (dB)	Spurious Response (dB)	GDT Deviation (μs)	Input/Output Impedance (ohm)
SFSCD20M0WF01-R0	20.000	fn±820 min.	3.6 max. (Total) [within 20dB]	6.0 max. [at minimum loss point]	2.0 max. [within 3dB Bandwidth]	34/23 min. [within 15MHz to fn / fn to 25MHz]	0.4 max. [within fn±750kHz]	470

For safety purposes, connect the output of filters to the IF amplifier through a D.C. blocking capacitor. Avoid applying a direct current to the output of ceramic filters.
The order quantity should be an integral multiple of the "Minimum Quantity" shown in package page in this catalog.

■ Test Circuit

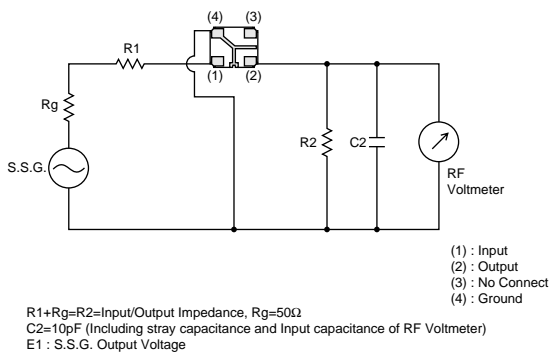

■ Frequency Characteristics

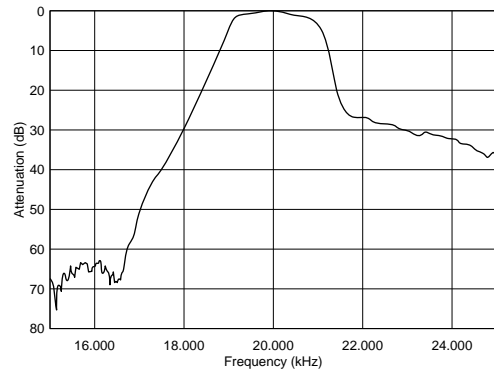
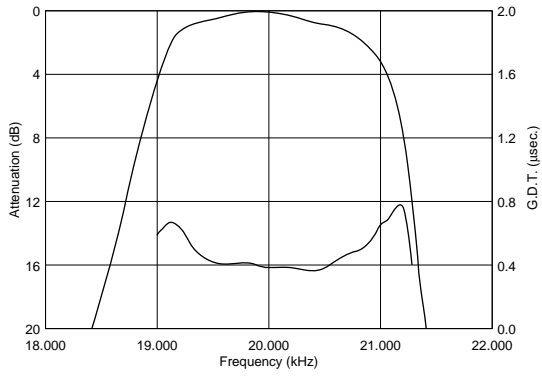

Ceramic Filters (CERAFIL®)/Ceramic Discriminators for Communications Equipment



CERAFIL® MHz SMD Type SFSCE10M7 Series

SFSCE series are chip surface mount filter and available for 3dB bandwidth at 700kHz to 1.3MHz. (more than twice width compared with current types) They have 1.0mm max. thickness and small mounting area. (4.5x3.8mm)

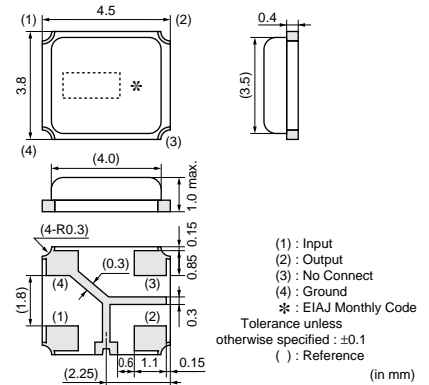
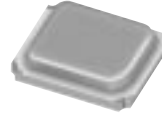

■ Features

1. The filters are mountable by automatic placers.
2. They are slim, at only 1.0mm max. thickness, and have a small mounting area (4.5x3.8mm) enabling flexible PCB design.
3. Available lead (Pb) free solder reflow.
4. Operating temperature range: -20 to +80 (degree C)
Storage temperature range: -40 to +85 (degree C)

■ Applications

1. SS digital communication system
2. Digital wireless audio
3. PHS Evolution system
4. RFID Reader Writer
5. RKE

12

Part Number	Nominal Center Frequency (fn) (MHz)	3dB Bandwidth (kHz)	Stop Bandwidth (MHz)	Insertion Loss (dB)	Ripple (dB)	Spurious Response (dB)	GDT Deviation (μs)	Input/Output Impedance (ohm)
SFSCE10M7WF03-R0	10.700	fn±500 min.	2.2 max. (Total) [within 20dB]	6.0 max. [at minimum loss point]	2.0 max. [within 3dB Bandwidth]	30/25 min. [within 5.7MHz to fn / fn to 15.7MHz]	0.6 max. [within fn±400kHz]	470
SFSCE10M7WF04-R0	10.700	fn±400 min.	1.8 max. (Total) [within 20dB]	6.0 max. [at minimum loss point]	1.5 max. [within 3dB Bandwidth]	35/25 min. [within 5.7MHz to fn / fn to 15.7MHz]	0.6 max. [within fn±325kHz]	470
SFSCE10M7WF05-R0	10.700	fn±325 min.	1.7 max. (Total) [within 20dB]	6.0 max. [at minimum loss point]	1.5 max. [within 3dB Bandwidth]	40/30 min. [within 5.7MHz to fn / fn to 15.7MHz]	0.6 max. [within fn±250kHz]	470

For safety purposes, connect the output of filters to the IF amplifier through a D.C. blocking capacitor. Avoid applying a direct current to the output of ceramic filters. The order quantity should be an integral multiple of the "Minimum Quantity" shown in package page in this catalog.

■ Test Circuit

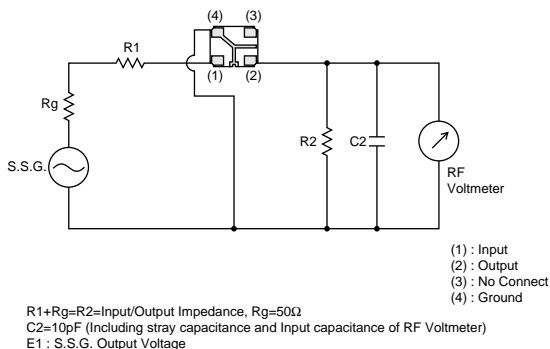

■ Frequency Characteristics

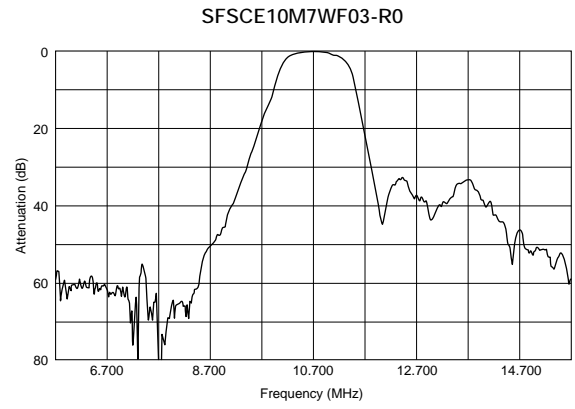
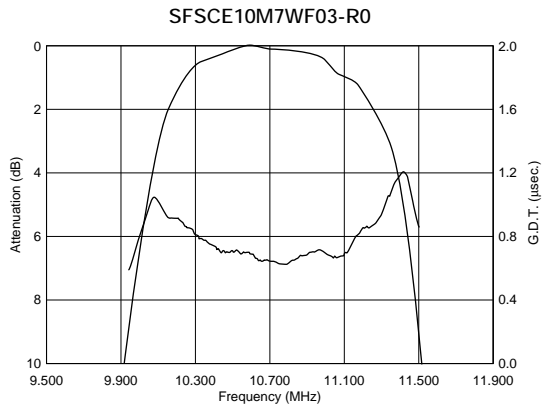

Ceramic Filters (CERAFIL[®])/Ceramic Discriminators for Communications Equipment



CERAFIL[®] Plastic Case General Use CFULA Series

CFULA series are high selectivity ceramic filters, which consist of 4 ceramic elements connected in a ladder form.

Most suitable for digital communications and cellular phones because of their improved GDT characteristics.

■ Features

1. High selectivity
2. A variety of bandwidths available
3. Excellent GDT characteristics are available within pass bandwidth.
4. Easily mounted on a printed circuit board
5. Operating temperature range: -20 to +80 (degree C)
Storage temperature range: -40 to +85 (degree C)

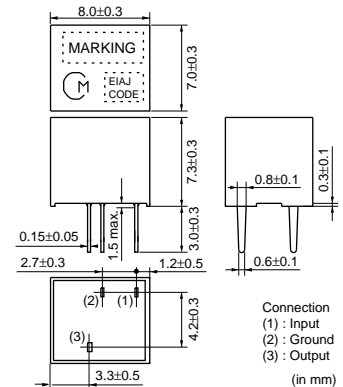

Part Number	Center Frequency (fo) (kHz)	6dB Bandwidth (kHz)	Stop Bandwidth (kHz)	Stop Band Attenuation (dB)	Insertion Loss (dB)	Input/Output Impedance (ohm)
CFULA455KB2A-B0	455.0 ±2.0kHz	fn±15.0 min.	fn±30.0 max. [within 40dB]	27 min. [within fn±100kHz]	4.0 max. [at minimum loss point]	1500
CFULA455KC2A-B0	455.0 ±2.0kHz	fn±12.5 min.	fn±24.0 max. [within 40dB]	27 min. [within fn±100kHz]	4.0 max. [at minimum loss point]	1500
CFULA455KD4A-B0	455.0 ±1.5kHz	fn±10.0 min.	fn±20.0 max. [within 40dB]	27 min. [within fn±100kHz]	4.0 max. [at minimum loss point]	1500
CFULA455KE4A-B0	455.0 ±1.5kHz	fn±7.5 min.	fn±15.0 max. [within 40dB]	27 min. [within fn±100kHz]	6.0 max. [at minimum loss point]	1500
CFULA455KF4A-B0	455.0 ±1.5kHz	fn±6.0 min.	fn±12.5 max. [within 40dB]	27 min. [within fn±100kHz]	6.0 max. [at minimum loss point]	2000
CFULA455KG1A-B0	455.0 ±1.0kHz	fn±4.5 min.	fn±10.0 max. [within 40dB]	25 min. [within fn±100kHz]	6.0 max. [at minimum loss point]	2000
CFULA455KH1A-B0	455.0 ±1.0kHz	fn±3.0 min.	fn±9.0 max. [within 40dB]	35 min. [within fn±100kHz]	6.0 max. [at minimum loss point]	2000

Center frequency (fo) defined by the center of 6dB bandwidth.
(fn) means nominal center frequency 455kHz.

For safety purposes, connect the output of filters to the IF amplifier through a D.C. blocking capacitor. Avoid applying a direct current to the output of ceramic filters.
The order quantity should be an integral multiple of the "Minimum Quantity" shown in package page in this catalog.

■ Test Circuit

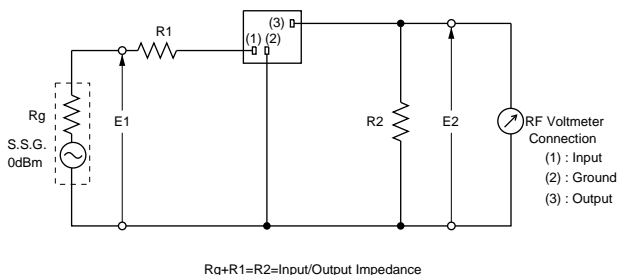

■ Frequency Characteristics

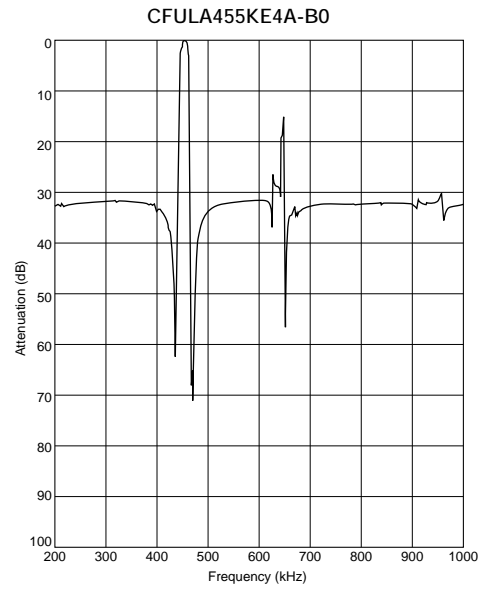
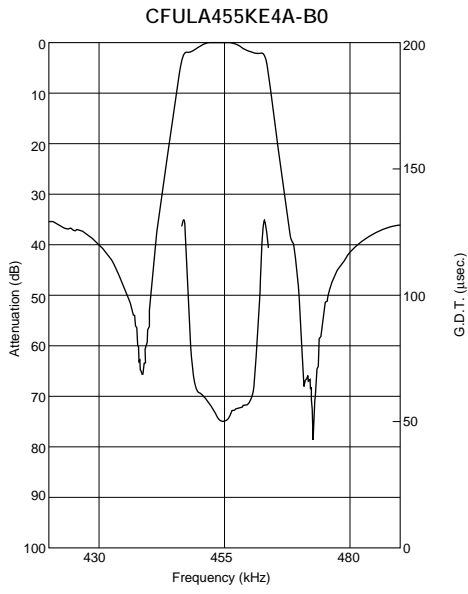

Ceramic Filters (CERAFIL[®])/Ceramic Discriminators for Communications Equipment



CERAFIL[®] Plastic Case Miniaturized Type CFWLA Series

Ceramic filter CFWLA series are low profile high selectivity ceramic filters which use 6 elements in ladder form.

They are best suitable to high-class transceivers, cordless telephones and amateur radios.

■ Features

1. Low profile, high selectivity
2. Available bandwidths are B to J as standard
3. Easily mountable on any PC board
4. Operating temperature range: -20 to +80 (degree C)
Storage temperature range: -40 to +85 (degree C)

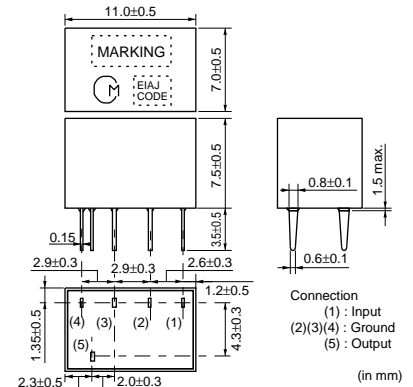

Part Number	Nominal Center Frequency (fn) (kHz)	6dB Bandwidth (kHz)	Stop Bandwidth (kHz)	Stop Band Attenuation (dB)	Insertion Loss (dB)	Ripple (dB)	Input/Output Impedance (ohm)
CFWLA455KBFA-B0	455	fn±15.0 min.	fn±30.0 max. [within 50dB]	35 min. [within fn±100kHz]	4.0 max. [at minimum loss point]	3.0 max. [within fn±10kHz]	1500
CFWLA455KCFA-B0	455	fn±12.5 min.	fn±24.0 max. [within 50dB]	35 min. [within fn±100kHz]	4.0 max. [at minimum loss point]	3.0 max. [within fn±8kHz]	1500
CFWLA455KDFA-B0	455	fn±10.0 min.	fn±20.0 max. [within 50dB]	35 min. [within fn±100kHz]	4.0 max. [at minimum loss point]	3.0 max. [within fn±7kHz]	1500
CFWLA455KEFA-B0	455	fn±7.5 min.	fn±15.0 max. [within 50dB]	35 min. [within fn±100kHz]	6.0 max. [at minimum loss point]	3.0 max. [within fn±5kHz]	1500
CFWLA455KFFA-B0	455	fn±6.0 min.	fn±12.5 max. [within 50dB]	35 min. [within fn±100kHz]	6.0 max. [at minimum loss point]	3.0 max. [within fn±4kHz]	2000
CFWLA455KGFA-B0	455	fn±4.5 min.	fn±10.0 max. [within 50dB]	35 min. [within fn±100kHz]	6.0 max. [at minimum loss point]	2.0 max. [within fn±3kHz]	2000
CFWLA455KHFA-B0	455	fn±3.0 min.	fn±9.0 max. [within 50dB]	60 min. [within fn±100kHz]	6.0 max. [at minimum loss point]	2.0 max. [within fn±2kHz]	2000
CFWLA455KJFA-B0	455	fn±2.0 min.	fn±7.5 max. [within 50dB]	60 min. [within fn±100kHz]	7.0 max. [at minimum loss point]	2.0 max. [within fn±1.5kHz]	2000

For safety purposes, connect the output of filters to the IF amplifier through a D.C. blocking capacitor. Avoid applying a direct current to the output of ceramic filters. The order quantity should be an integral multiple of the "Minimum Quantity" shown in package page in this catalog.

■ Test Circuit

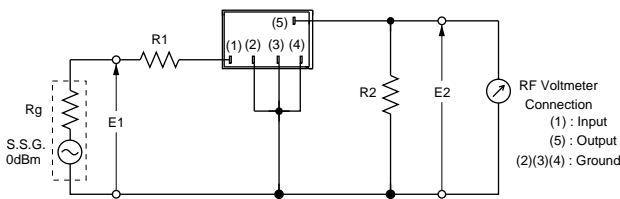

$R_g + R_1 = R_2 = \text{Input/Output Impedance}$

■ Frequency Characteristics

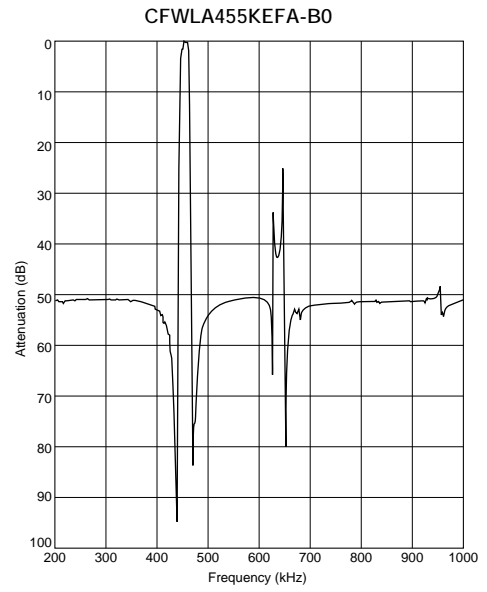
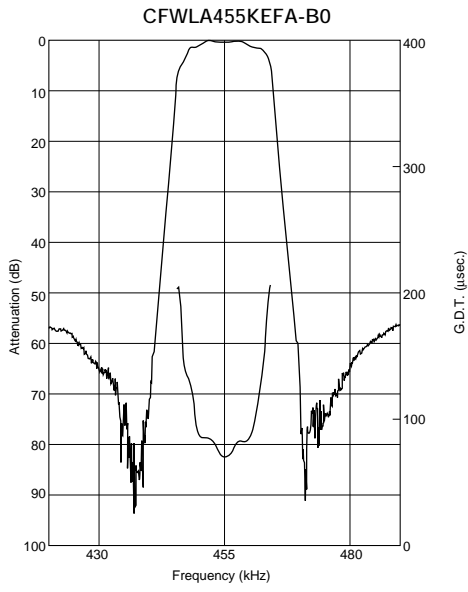

Ceramic Filters (CERAFIL[®])/Ceramic Discriminators for Communications Equipment



CERAFIL[®] Plastic Case Miniaturized Type CFULB Series

CFULB series ceramic filters are miniature, high performance ceramic filters composed of piezoelectric elements connected in a ladder form.

These filters, only 6.3mm high, are 65% the volume of conventional types. (CFULA455K series) They are well suited for miniaturizing various kinds of communications equipment, pocket pagers, car radios, cordless telephones and mobile telephones.

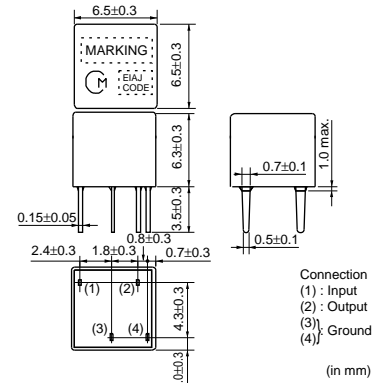

■ Features

1. Miniature and high selectivity
2. A variety of bandwidths are available
3. Operating temperature range: -20 to +80 (degree C)
Storage temperature range: -40 to +85 (degree C)

Part Number	Center Frequency (fo) (kHz)	6dB Bandwidth (kHz)	Stop Bandwidth (kHz)	Stop Band Attenuation (dB)	Insertion Loss (dB)	Input/Output Impedance (ohm)
CFULB455KB2A-B0	455.0 ±2.0kHz	fn±15.0 min.	fn±30.0 max. [within 40dB]	27 min. [within fn±100kHz]	4.0 max. [at minimum loss point]	1500
CFULB455KC2A-B0	455.0 ±2.0kHz	fn±12.5 min.	fn±24.0 max. [within 40dB]	27 min. [within fn±100kHz]	4.0 max. [at minimum loss point]	1500
CFULB455KD4A-B0	455.0 ±1.5kHz	fn±10.0 min.	fn±20.0 max. [within 40dB]	27 min. [within fn±100kHz]	4.0 max. [at minimum loss point]	1500
CFULB455KE4A-B0	455.0 ±1.5kHz	fn±7.5 min.	fn±15.0 max. [within 40dB]	27 min. [within fn±100kHz]	6.0 max. [at minimum loss point]	1500
CFULB455KF4A-B0	455.0 ±1.5kHz	fn±6.0 min.	fn±12.5 max. [within 40dB]	27 min. [within fn±100kHz]	6.0 max. [at minimum loss point]	2000
CFULB455KG1A-B0	455.0 ±1.0kHz	fn±4.5 min.	fn±10.0 max. [within 40dB]	25 min. [within fn±100kHz]	6.0 max. [at minimum loss point]	2000
CFULB455KH1A-B0	455.0 ±1.0kHz	fn±3.0 min.	fn±9.0 max. [within 40dB]	35 min. [within fn±100kHz]	6.0 max. [at minimum loss point]	2000
CFULB455KJ1A-B0	455.0 ±1.0kHz	fn±2.0 min.	fn±7.5 max. [within 40dB]	35 min. [within fn±100kHz]	6.0 max. [at minimum loss point]	2000

Center frequency (fo) defined by the center of 6dB bandwidth.
(fn) means nominal center frequency 455kHz.

CFULB455K_series filters are 4-element ceramic filters and miniature versions of CFULA455K_series.

For safety purposes, connect the output of filters to the IF amplifier through a D.C. blocking capacitor. Avoid applying a direct current to the output of ceramic filters.

The order quantity should be an integral multiple of the "Minimum Quantity" shown in package page in this catalog.

■ Test Circuit

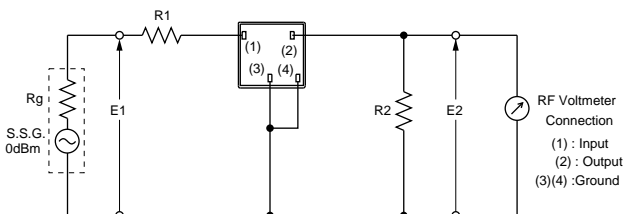

$R_g + R_1 = R_2 = \text{Input/Output Impedance}$

■ Frequency Characteristics

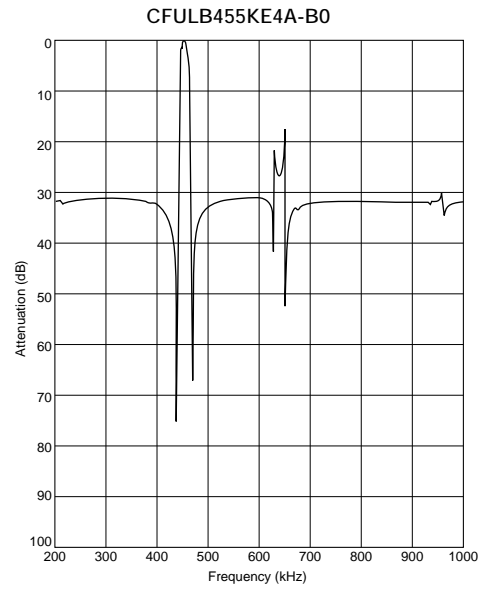
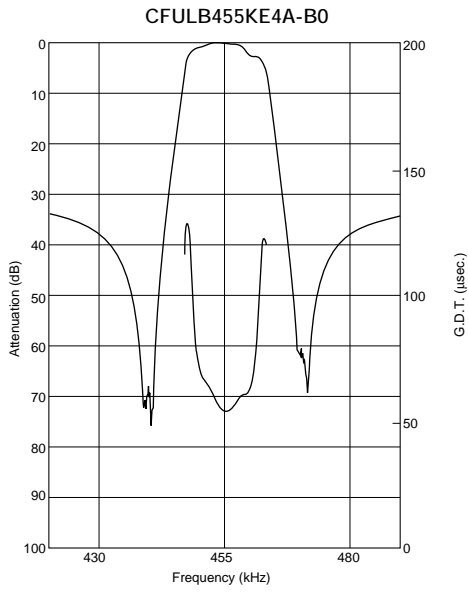

Ceramic Filters (CERAFIL®)/Ceramic Discriminators for Communications Equipment



CERAFIL® Plastic Case General Use CFWLB Series

CFWLB series ceramic filters are miniature, high performance ceramic filters composed of piezoelectric elements connected in a ladder form. These filters, only 6.3mm high, are 67% the volume of conventional types. (CFWLB series) They are well suited for miniaturizing various kinds of communications equipment, pocket pagers, pagers, car radios, cordless telephones and mobile telephones.

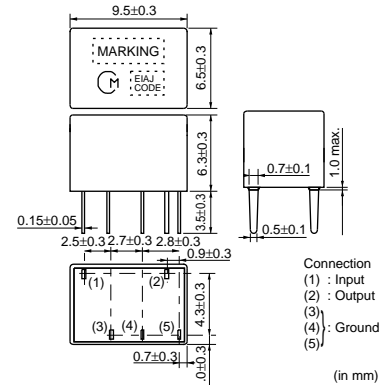

■ Features

1. Miniature and high selectivity
2. A variety of bandwidths are available.
3. Operating temperature range: -20 to +80 (degree C)
Storage temperature range: -40 to +85 (degree C)

Part Number	Nominal Center Frequency (fn) (kHz)	6dB Bandwidth (kHz)	Stop Bandwidth (kHz)	Stop Band Attenuation (dB)	Insertion Loss (dB)	Input/Output Impedance (ohm)
CFWLB455KBFA-B0	455	fn±15.0 min.	fn±30.0 max. [within 50dB]	35 min. [within fn±100kHz]	4.0 max. [at minimum loss point]	1500
CFWLB455KCFA-B0	455	fn±12.5 min.	fn±24.0 max. [within 50dB]	35 min. [within fn±100kHz]	4.0 max. [at minimum loss point]	1500
CFWLB455KDFA-B0	455	fn±10.0 min.	fn±20.0 max. [within 50dB]	35 min. [within fn±100kHz]	4.0 max. [at minimum loss point]	1500
CFWLB455KEFA-B0	455	fn±7.5 min.	fn±15.0 max. [within 50dB]	35 min. [within fn±100kHz]	6.0 max. [at minimum loss point]	1500
CFWLB455KEFA004-B0	455	fn±7.5 min.	fn±15.0 max. [within 60dB]	60 min. [within fn±15kHz to 30kHz]	5.0 max. [at fn]	1500
CFWLB455KFFA-B0	455	fn±6.0 min.	fn±12.5 max. [within 50dB]	35 min. [within fn±100kHz]	6.0 max. [at minimum loss point]	2000
CFWLB455KGFA-B0	455	fn±4.5 min.	fn±10.0 max. [within 50dB]	35 min. [within fn±100kHz]	6.0 max. [at minimum loss point]	2000
CFWLB455KHFA-B0	455	fn±3.0 min.	fn±9.0 max. [within 50dB]	55 min. [within fn±100kHz]	6.0 max. [at minimum loss point]	2000
CFWLB455KJFA-B0	455	fn±2.0 min.	fn±7.0 max. [within 50dB]	55 min. [within fn±100kHz]	7.0 max. [at minimum loss point]	2000

CFWLB455K_series filters are 4-element ceramic filters and miniature versions of CFWLA455K_series.

For safety purposes, connect the output of filters to the IF amplifier through a D.C. blocking capacitor. Avoid applying a direct current to the output of ceramic filters.

The order quantity should be an integral multiple of the "Minimum Quantity" shown in package page in this catalog.

■ Test Circuit

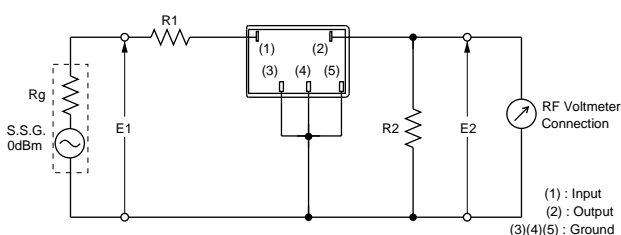

$R_g + R_1 = R_2 = \text{Input/Output Impedance}$

■ Frequency Characteristics

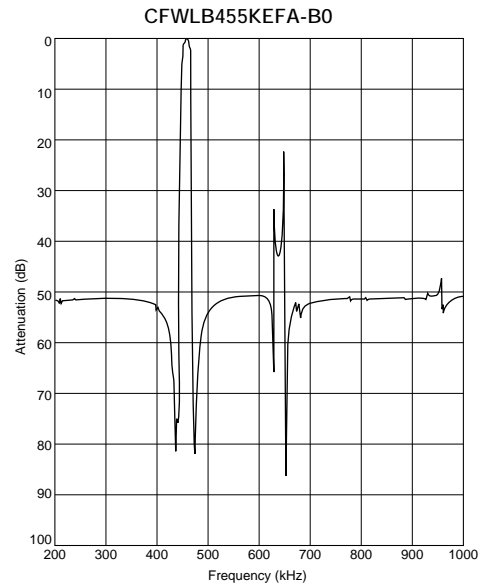
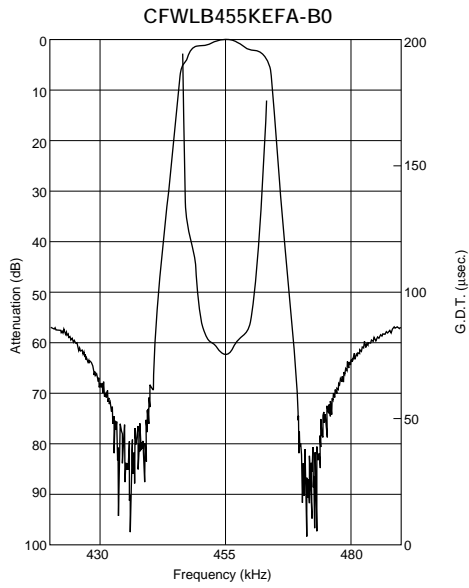

Ceramic Filters (CERAFIL®)/Ceramic Discriminators for Communications Equipment



CERAFIL® Plastic Case Group Delay Flat Type CFULA_Y Series

CFULA_Y series are high selectivity ceramic filters, which consist of 4 ceramic elements connected in a ladder form. Most suitable for digital communications and cellular phones because of their improved GDT characteristics.

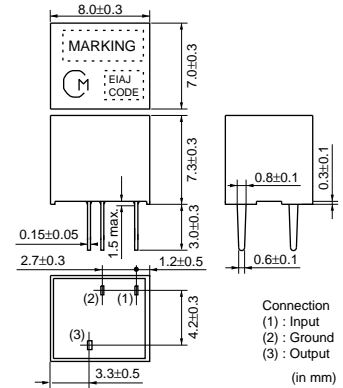

■ Features

1. High selectivity
2. A variety of bandwidths are available.
3. Excellent GDT characteristics are available within pass bandwidth.
4. Easily mounted on a printed circuit board
5. Operating temperature range: -20 to +80 (degree C)
Storage temperature range: -40 to +85 (degree C)

Part Number	Center Frequency (fo) (kHz)	6dB Bandwidth (kHz)	Stop Bandwidth (kHz)	Stop Band Attenuation (dB)	Insertion Loss (dB)	GDT Deviation (μs)	Input/Output Impedance (ohm)
CFULA455KB4Y-B0	455.0 ±1.5kHz	fn±15.0 min.	fn±35.0 max. [within 40dB]	25 min. [within fn±100kHz]	5.0 max. [at minimum loss point]	15.0 max. [within fn±10kHz]	1500
CFULA455KC4Y-B0	455.0 ±1.5kHz	fn±12.5 min.	fn±30.0 max. [within 40dB]	25 min. [within fn±100kHz]	6.0 max. [at minimum loss point]	15.0 max. [within fn±8kHz]	1500
CFULA455KD1Y-B0	455.0 ±1.0kHz	fn±10.0 min.	fn±25.0 max. [within 40dB]	23 min. [within fn±100kHz]	7.0 max. [at minimum loss point]	20.0 max. [within fn±7kHz]	1500
CFULA455KE1Y-B0	455.0 ±1.0kHz	fn±7.5 min.	fn±20.0 max. [within 40dB]	23 min. [within fn±100kHz]	8.0 max. [at minimum loss point]	20.0 max. [within fn±5kHz]	1500
CFULA455KF1Y-B0	455.0 ±1.0kHz	fn±6.0 min.	fn±17.5 max. [within 40dB]	23 min. [within fn±100kHz]	9.0 max. [at minimum loss point]	20.0 max. [within fn±4kHz]	2000
CFULA455KG1Y-B0	455.0 ±1.0kHz	fn±4.5 min.	fn±15.0 max. [within 40dB]	23 min. [within fn±100kHz]	10.0 max. [at minimum loss point]	20.0 max. [within fn±3kHz]	2000

Center frequency (fo) defined by the center of 6dB bandwidth.
(fn) means nominal center frequency 455kHz.

For safety purposes, connect the output of filters to the IF amplifier through a D.C. blocking capacitor. Avoid applying a direct current to the output of ceramic filters. The order quantity should be an integral multiple of the "Minimum Quantity" shown in package page in this catalog.

■ Test Circuit

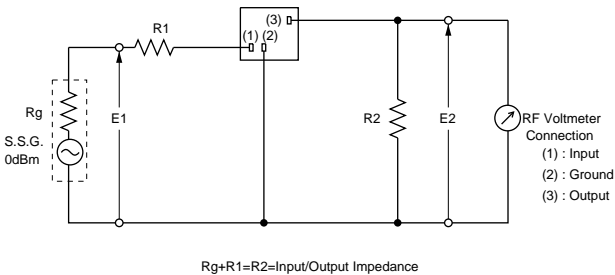

■ Frequency Characteristics

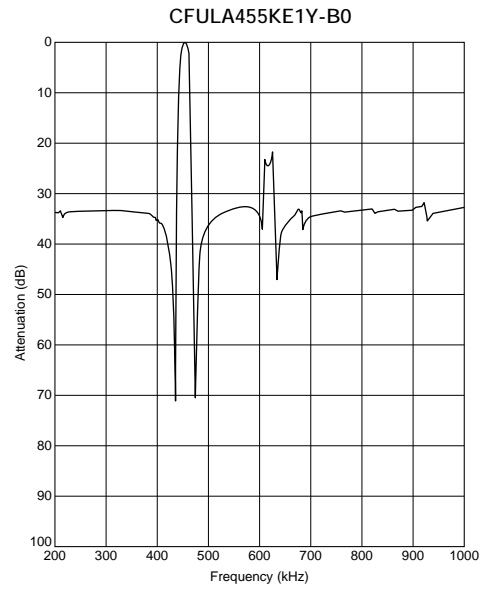
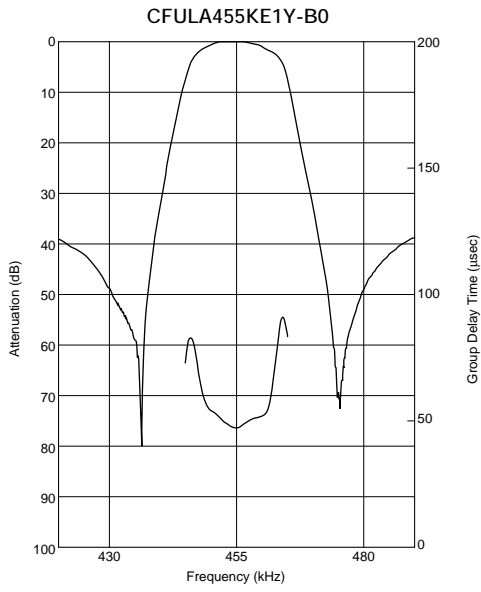

Ceramic Filters (CERAFIL®)/Ceramic Discriminators for Communications Equipment



CERAFIL® Plastic Case Group Delay Flat Type CFWLA_Y Series

CFWLA_Y series are high selectivity ceramic filters, which consist of 6 ceramic elements connected in a ladder form.

Most suitable for digital communications and mobile telephones because of their improved GDT characteristics.

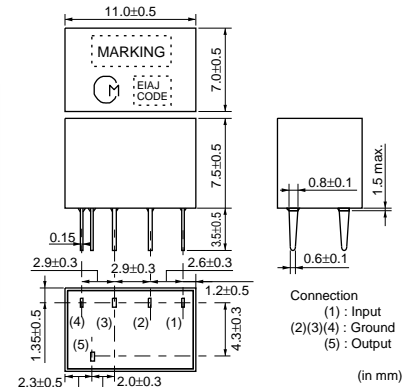

■ Features

1. High selectivity
2. A variety of bandwidths are available
3. Excellent GDT characteristics are available within pass bandwidth.
4. Easily mounted on a printed circuit board
5. Operating temperature range: -20 to +80 (degree C)
Storage temperature range: -40 to +85 (degree C)

Part Number	Center Frequency (fo) (kHz)	6dB Bandwidth (kHz)	Stop Bandwidth (kHz)	Stop Band Attenuation (dB)	Insertion Loss (dB)	GDT Deviation (μs)	Input/Output Impedance (ohm)
CFWLA455KB4Y-B0	455.0 ±1.5kHz	fn±15.0 min.	fn±35.0 max. [within 50dB]	40 min. [within fn±100kHz]	6.0 max. [at minimum loss point]	30.0 max. [within fn±10kHz]	1500
CFWLA455KC4Y-B0	455.0 ±1.5kHz	fn±12.5 min.	fn±30.0 max. [within 50dB]	40 min. [within fn±100kHz]	7.0 max. [at minimum loss point]	30.0 max. [within fn±8kHz]	1500
CFWLA455KD1Y-B0	455.0 ±1.0kHz	fn±10.0 min.	fn±25.0 max. [within 50dB]	40 min. [within fn±100kHz]	8.0 max. [at minimum loss point]	30.0 max. [within fn±7kHz]	1500
CFWLA455KE1Y-B0	455.0 ±1.0kHz	fn±7.5 min.	fn±20.0 max. [within 50dB]	40 min. [within fn±100kHz]	9.0 max. [at minimum loss point]	30.0 max. [within fn±5kHz]	1500
CFWLA455KF1Y-B0	455.0 ±1.0kHz	fn±6.0 min.	fn±17.5 max. [within 50dB]	40 min. [within fn±100kHz]	10.0 max. [at minimum loss point]	40.0 max. [within fn±4kHz]	2000
CFWLA455KG1Y-B0	455.0 ±1.0kHz	fn±4.5 min.	fn±15.0 max. [within 50dB]	40 min. [within fn±100kHz]	11.0 max. [at minimum loss point]	40.0 max. [within fn±3kHz]	2000

Center frequency (fo) defined by the center of 6dB bandwidth.
(fn) means nominal center frequency 455kHz.

For safety purposes, connect the output of filters to the IF amplifier through a D.C. blocking capacitor. Avoid applying a direct current to the output of ceramic filters.
The order quantity should be an integral multiple of the "Minimum Quantity" shown in package page in this catalog.

■ Test Circuit

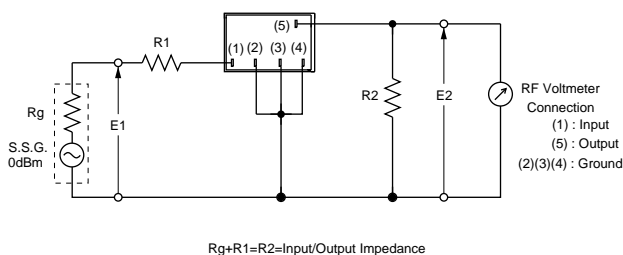

■ Frequency Characteristics

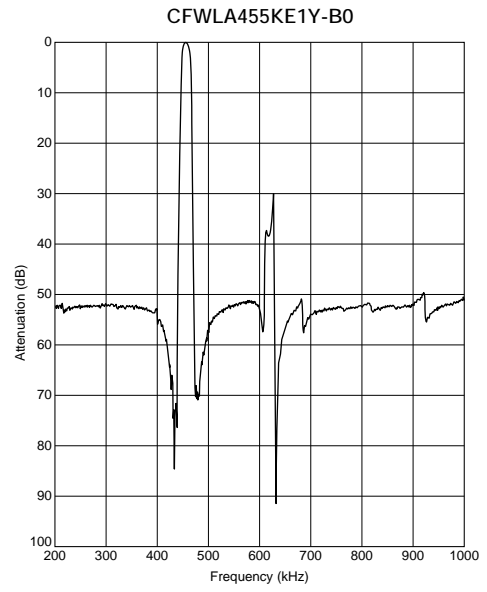
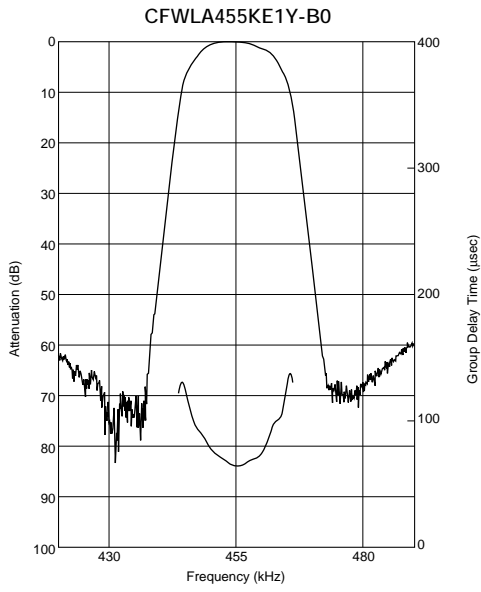

Ceramic Filters (CERAFIL[®])/Ceramic Discriminators for Communications Equipment



CERAFIL[®] Plastic Case Group Delay Flat Type Miniaturized Type CFULB_Y Series

Ceramic filter CFULB_Y series are miniature and high performance filters. These filters, only 6.3mm high, are 65% the volume of conventional types (CFULA455K_Y series).

Well suited for miniaturizing communications equipment, especially for a cellular phone.

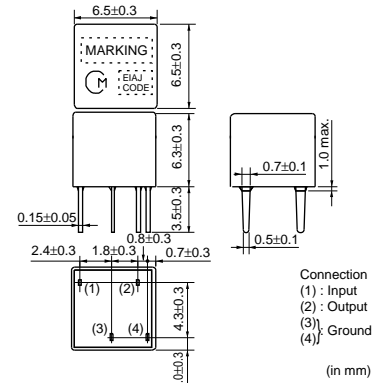

■ Features

1. Miniature, flat GDT characteristics
2. Suitable for a cellular phone
3. A variety of bandwidths are available.
4. Operating temperature range: -20 to +80 (degree C)
Storage temperature range: -40 to +85 (degree C)

Part Number	Center Frequency (fo) (kHz)	6dB Bandwidth (kHz)	Stop Bandwidth (kHz)	Stop Band Attenuation (dB)	Insertion Loss (dB)	GDT Deviation (μs)	Input/Output Impedance (ohm)
CFULB455KB4Y-B0	455.0 ±1.5kHz	fn±15.0 min.	fn±35.0 max. [within 40dB]	25 min. [within fn±100kHz]	5.0 max. [at minimum loss point]	15.0 max. [within fn±10kHz]	1500
CFULB455KC4Y-B0	455.0 ±1.5kHz	fn±12.5 min.	fn±30.0 max. [within 40dB]	25 min. [within fn±100kHz]	6.0 max. [at minimum loss point]	15.0 max. [within fn±8kHz]	1500
CFULB455KD1Y-B0	455.0 ±1.0kHz	fn±10.0 min.	fn±25.0 max. [within 40dB]	23 min. [within fn±100kHz]	7.0 max. [at minimum loss point]	20.0 max. [within fn±7kHz]	1500
CFULB455KE1Y-B0	455.0 ±1.0kHz	fn±7.5 min.	fn±20.0 max. [within 40dB]	23 min. [within fn±100kHz]	8.0 max. [at minimum loss point]	20.0 max. [within fn±5kHz]	1500
CFULB455KF1Y-B0	455.0 ±1.0kHz	fn±6.0 min.	fn±17.5 max. [within 40dB]	23 min. [within fn±100kHz]	9.0 max. [at minimum loss point]	20.0 max. [within fn±4kHz]	2000
CFULB455KG1Y-B0	455.0 ±1.0kHz	fn±4.5 min.	fn±15.0 max. [within 40dB]	23 min. [within fn±100kHz]	10.0 max. [at minimum loss point]	20.0 max. [within fn±3kHz]	2000

Center frequency (fo) defined by the center of 6dB bandwidth.
(fn) means nominal center frequency 455kHz.

CFULB455K_Y series filters are 4-element ceramic filters and miniature versions of CFULA455K_Y series.

For safety purposes, connect the output of filters to the IF amplifier through a D.C. blocking capacitor. Avoid applying a direct current to the output of ceramic filters.

The order quantity should be an integral multiple of the "Minimum Quantity" shown in package page in this catalog.

■ Test Circuit

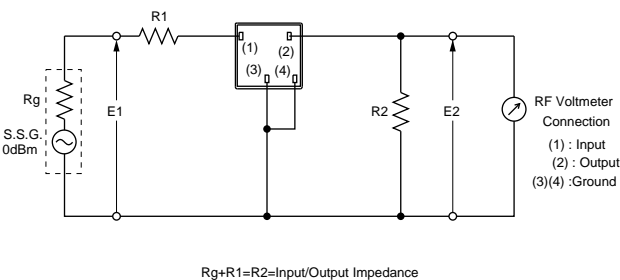

■ Frequency Characteristics

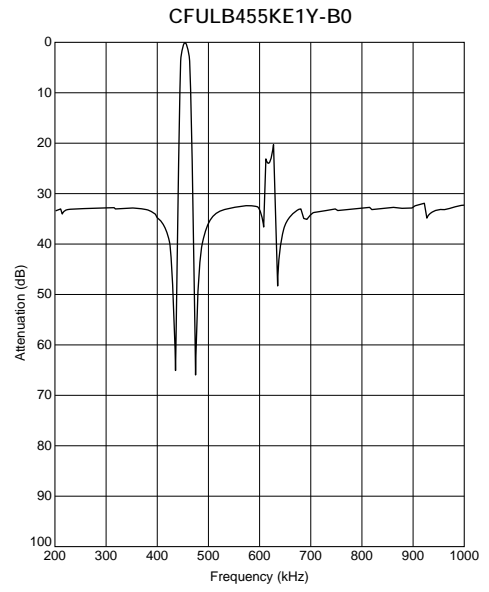
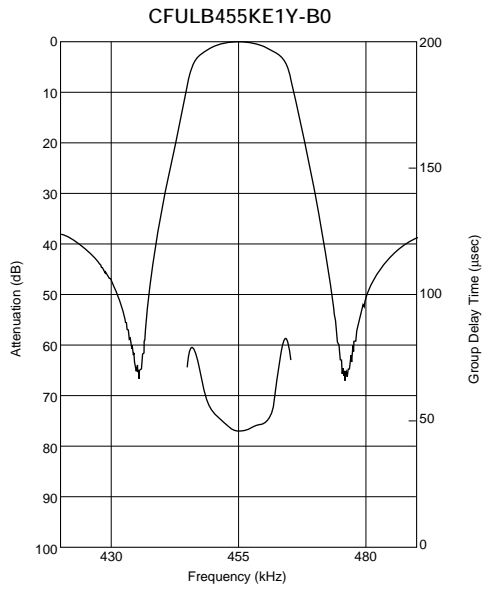

Ceramic Filters (CERAFIL®)/Ceramic Discriminators for Communications Equipment



CERAFIL® Plastic Case Group Delay Flat Type CFWLB_Y Series

Ceramic filter CFWLB_Y series are miniature and high-performance filters. These filters, only 6.3mm high, are 67% the volume of conventional types (CFWLA455K_Y series).

Well suited for miniaturizing communications equipment, especially for a cellular phone.

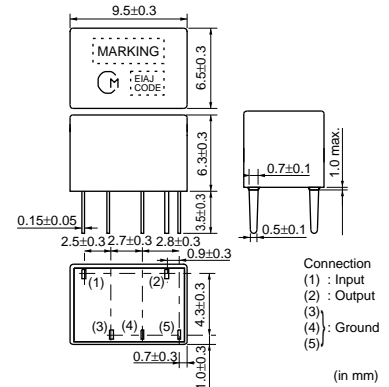

■ Features

1. Miniature, flat GDT characteristics
2. Suitable for a cellular phone
3. A variety of bandwidths are available.
4. Operating temperature range: -20 to +80 (degree C)
Storage temperature range: -40 to +85 (degree C)

Part Number	Center Frequency (fo) (kHz)	6dB Bandwidth (kHz)	Stop Bandwidth (kHz)	Stop Band Attenuation (dB)	Insertion Loss (dB)	GDT Deviation (μs)	Input/Output Impedance (ohm)
CFWLB455KB4Y-B0	455.0 ±1.5kHz	fn±15.0 min.	fn±30.0 max. [within 50dB]	40 min. [within fn±100kHz]	6.0 max. [at minimum loss point]	30.0 max. [within fn±10kHz]	1500
CFWLB455KC4Y-B0	455.0 ±1.5kHz	fn±12.5 min.	fn±27.5 max. [within 50dB]	40 min. [within fn±100kHz]	7.0 max. [at minimum loss point]	30.0 max. [within fn±8kHz]	1500
CFWLB455KD1Y-B0	455.0 ±1.0kHz	fn±10.0 min.	fn±25.0 max. [within 50dB]	40 min. [within fn±100kHz]	8.0 max. [at minimum loss point]	30.0 max. [within fn±7kHz]	1500
CFWLB455KE1Y-B0	455.0 ±1.0kHz	fn±7.5 min.	fn±20.0 max. [within 50dB]	40 min. [within fn±100kHz]	9.0 max. [at minimum loss point]	30.0 max. [within fn±5kHz]	1500
CFWLB455KF1Y-B0	455.0 ±1.0kHz	fn±6.0 min.	fn±17.5 max. [within 50dB]	40 min. [within fn±100kHz]	10.0 max. [at minimum loss point]	40.0 max. [within fn±4kHz]	2000
CFWLB455KG1Y-B0	455.0 ±1.0kHz	fn±4.5 min.	fn±15.0 max. [within 50dB]	40 min. [within fn±100kHz]	11.0 max. [at minimum loss point]	40.0 max. [within fn±3kHz]	2000

Center frequency (fo) defined by the center of 6dB bandwidth.
(fn) means nominal center frequency 455kHz.

CFWLB455K_Y series filters are 4-element ceramic filters and miniature versions of CFWLA455K_Y series.

For safety purposes, connect the output of filters to the IF amplifier through a D.C. blocking capacitor. Avoid applying a direct current to the output of ceramic filters. The order quantity should be an integral multiple of the "Minimum Quantity" shown in package page in this catalog.

■ Test Circuit

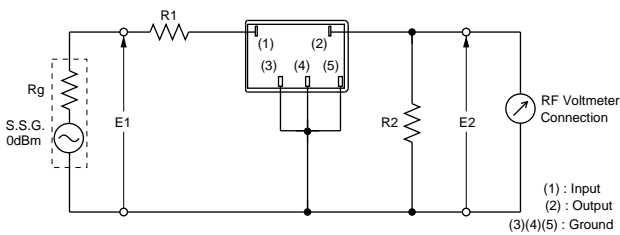

$R_g + R_1 = R_2 = \text{Input/Output Impedance}$

■ Frequency Characteristics

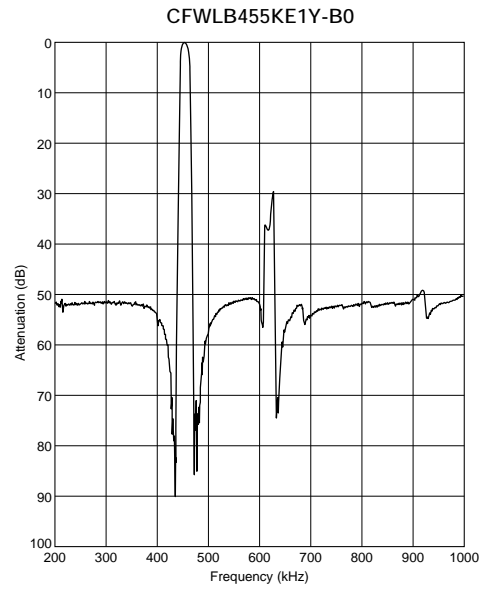
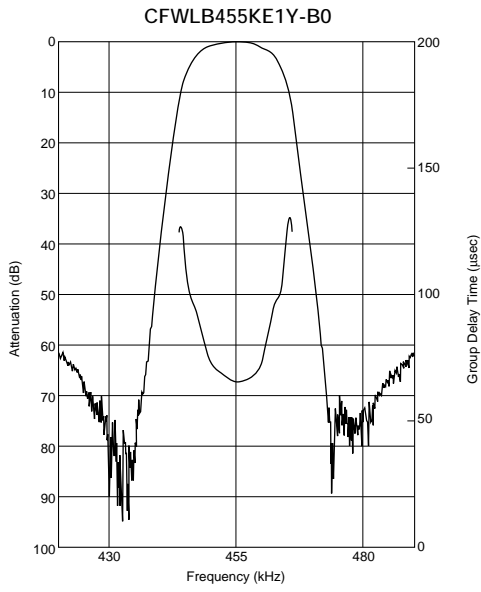

Ceramic Filters (CERAFIL®)/Ceramic Discriminators for Communications Equipment



kHz Type Ceramic Discriminators

Ceramic discriminator consists of wide band piezoelectric resonator.

It is ideal for mobile communications equipment due to its small size and light weight.

Standard line include products for wide range of applications, from cordless telecom to cellular telephone. It helps to realize adjustment free at detection circuit and down sizing.

■ Features

1. Small in size and light weight
2. Adjustment free at detection circuit
3. High sensitivity and stability
4. Wide range of standard products are available for various ICs.
5. Operating temperature range: -20 to +80 (degree C)
Storage temperature range: -40 to +85 (degree C)



CDBKB Series

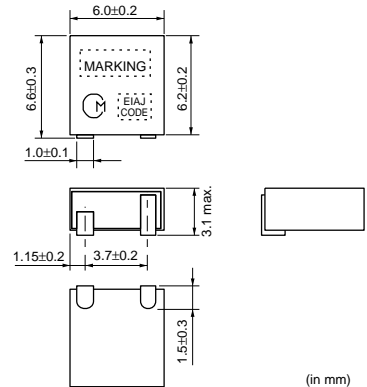

CDBLA Series

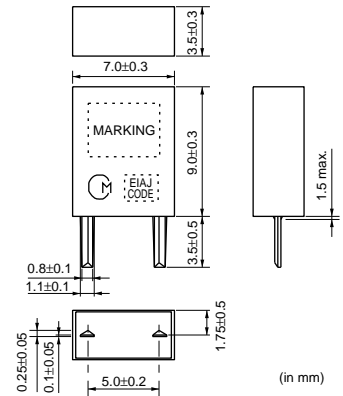

CDBLB_CAX Series

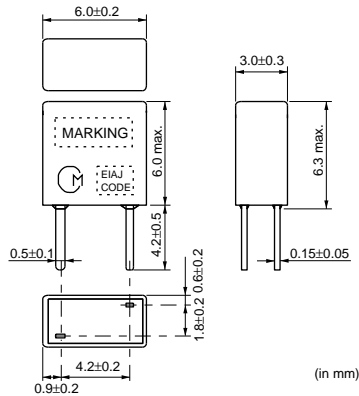

CDBLB_CAY Series

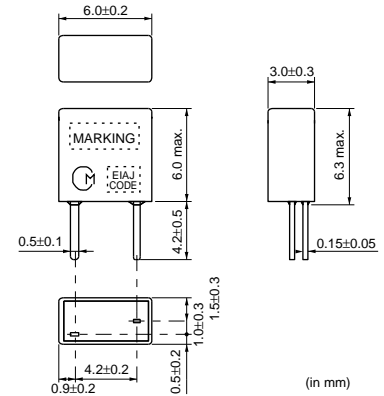

Specified by Impedance Characteristics (Type 1)

Part Number	Nominal Center Frequency (fn) (kHz)	Inclination of Impedance Curve(1)	Inclination of Impedance Curve(2)	Capacitance (C)	IC	IC Maker	Type
CDBLB455KCAX02-B0	455	447.0±1.5kHz (at Z =2.05kohm)	463.0±1.5kHz (at Z =10.0kohm)	140pF±20%	TA8104F	TOSHIBA	Lead
CDBLB455KCAX31-B0	455	447.0±1.5kHz (at Z =2.05kohm)	463.0±1.5kHz (at Z =10.0kohm)	140pF±20%	TA31141	TOSHIBA	Lead

For safety purposes, connect the output of filters to the IF amplifier through a D.C. blocking capacitor. Avoid applying a direct current to the output of ceramic filters. The order quantity should be an integral multiple of the "Minimum Quantity" shown in package page in this catalog.

■ Impedance Curve

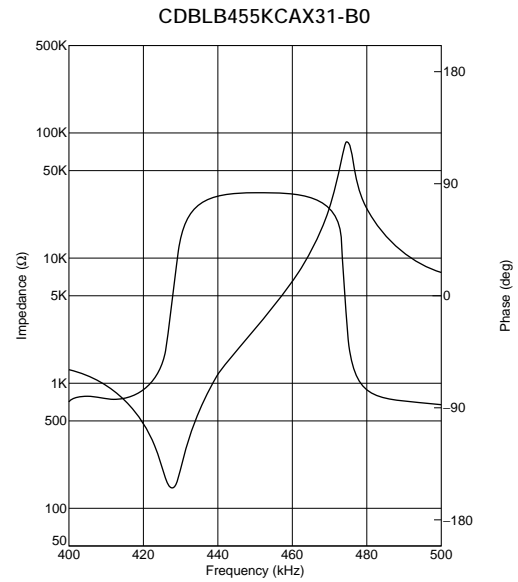
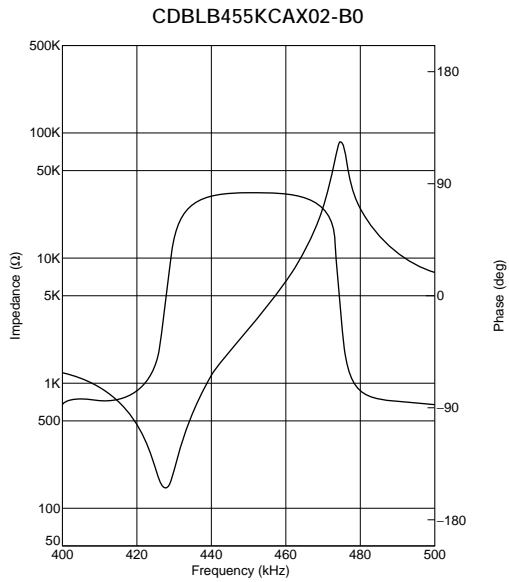

Specified by Impedance Characteristics (Type 2)

Part Number	Nominal Center Frequency (fn) (kHz)	Anti-resonant Frequency (Fa)	Delta F (Fa-Fr)	Resonant Resistance (R)	Capacitance (C)	IC	IC Maker	Type
CDBKB455KCAX33-R0	-	458.0±1.5kHz	42±4.0kHz	300ohm max.	280pF±20%	CXA1474	SONY	SMD
CDBLA455KCAY03-B0	-	455.0±1.5kHz	48±5.0kHz	70ohm max.	600pF±20%	CXA1184	SONY	Lead
CDBLB455KCAY03-B0	-	455.0±1.5kHz	46±5.0kHz	70ohm max.	550pF±20%	CXA1184M	SONY	Lead
CDBLB455KCAX15-B0	-	463.5±1.0kHz	43±2.0kHz	300ohm max.	140pF±20%	CXA1183M	SONY	Lead
CDBLB455KCAX25-B0	455	465.0±1.5kHz	45±4.0kHz	300ohm max.	135pF±20%	CXA1484	SONY	Lead
CDBLB455KCAX33-B0	455	465.0±1.5kHz	45±4.0kHz	300ohm max.	135pF±20%	CXA1474	SONY	Lead

For safety purposes, connect the output of filters to the IF amplifier through a D.C. blocking capacitor. Avoid applying a direct current to the output of ceramic filters. The order quantity should be an integral multiple of the "Minimum Quantity" shown in package page in this catalog.

■ Impedance Curve

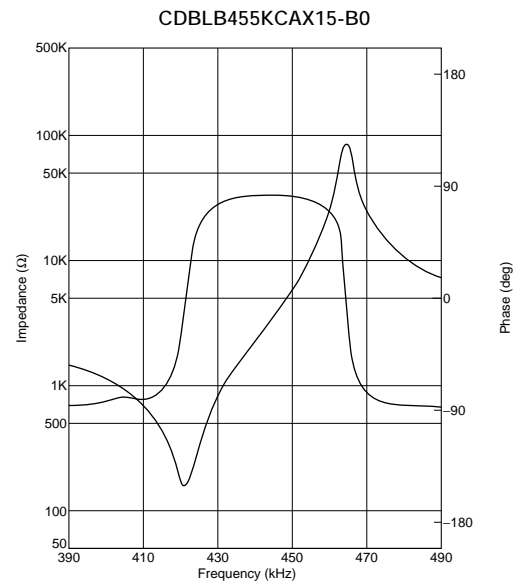
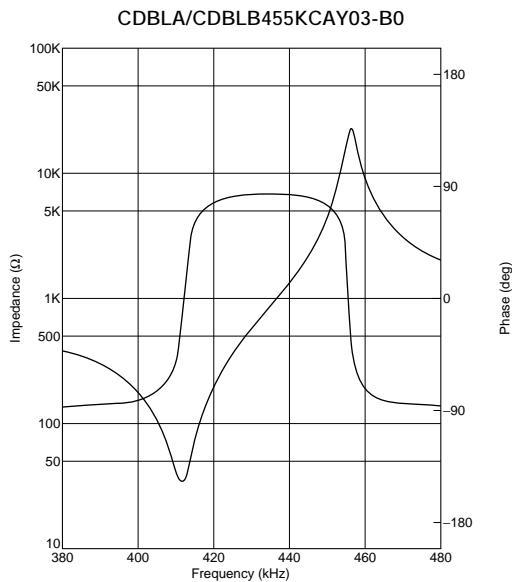

Continued from the preceding page.

Impedance Curve

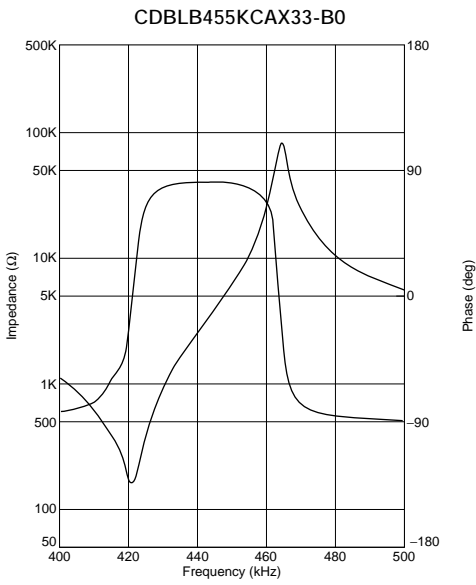
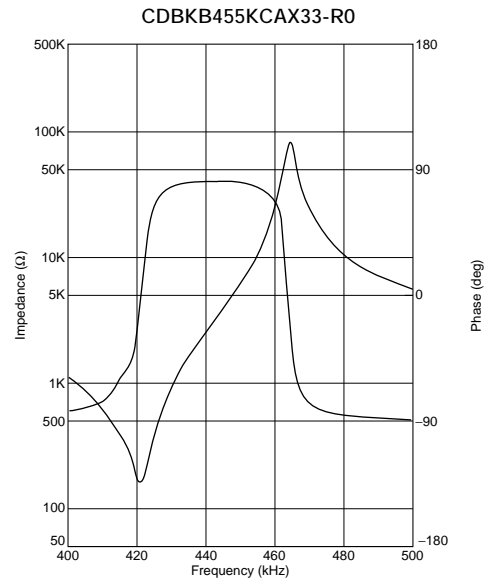
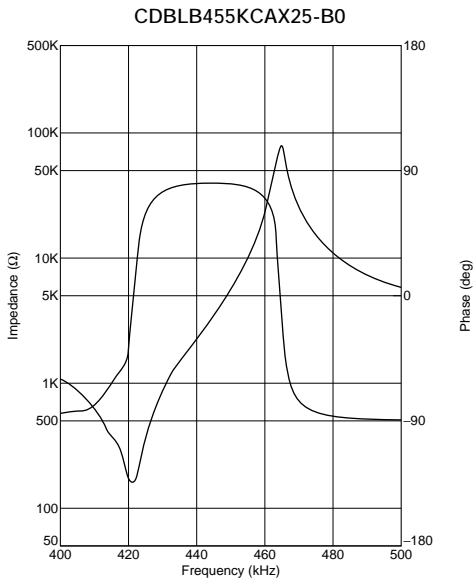

Specified by Recovered Audio Characteristics

Part Number	Nominal Center Frequency (fn) (kHz)	Recovered Audio 3dB BW (kHz)	Recovered Audio Output (mV)	Distortion (at fn) (%)	Distortion (%)	IC	IC Maker	Type
CDBKB455KCAY07-R0	455	fn±4.0 min.	350 ±60	3.0 max.	-	MC3357	MOTOROLA	SMD
CDBKB455KCAY09-R0	455	fn±4.0 min.	120 ±40	1.5 max.	-	NE604N	PHILIPS	SMD
CDBKB455KCAY13-R0	455	fn±4.0 min.	330 ±50	4.0 max.	-	CXA1003BM	SONY	SMD
CDBKB455KCAY16-R0	455	fn±4.0 min.	175 ±40	2.0 max.	-	MC3372	MOTOROLA	SMD
CDBKB455KCAY24-R0	455	fn±4.0 min.	100 ±40	2.0 max.	-	TA31136	TOSHIBA	SMD
CDBKB455KCAY27-R0	455	fn±4.0 min.	90 ±30	2.0 max.	-	TK10487	TOKO	SMD
CDBKB455KCAY28-R0	455	fn±4.0 min.	40 ±20	3.0 max.	-	TA31142F	TOSHIBA	SMD
CDBKB455KCAY29-R0	455	fn±4.0 min.	100 ±30	2.5 max.	-	NE605	PHILIPS	SMD
CDBKB455KCAY35-R0	455	fn±4.0 min.	100 ±40	2.5 max.	-	TK10930	TOKO	SMD
CDBKB455KCAY40-R0	455	fn±4.0 min.	40 ±20	3.5 max.	-	TA31145	TOSHIBA	SMD
CDBKB455KCAY49-R0	455	fn±4.0 min.	45 ±10	3.0 max.	-	MC3361	MOTOROLA	SMD
CDBKB455KCAY50-R0	455	fn±4.0 min.	64 ±6.4	4.0 max.	-	CXA3117N	SONY	SMD
CDBKB455KCAY66-R0	455	fn±4.2 min.	40 ±10	4.0 max.	-	NJM2590	JRC	SMD
CDBKB455KCLX36-R0	455	fn±13.0 min.	90 ±30	2.5 max.	5.0 max. [within fn ±6kHz]	NE(SA)606 /NE(SA)616	PHILIPS	SMD
CDBKB455KCLX39-R0	455	fn±11.0 min.	130 ±20	2.5 max.	7.0 max. [within fn ±8kHz]	NE607 /NE617	PHILIPS	SMD
CDBKB455KCLY13-R0	455	fn±13.0 min.	120 ±30	1.5 max.	5.0 max. [within fn ±8kHz]	CXA1003BM	SONY	SMD
CDBLA455KCAY07-B0	455	fn±4.0 min.	340 ±60	2.5 max.	-	MC3357	MOTOROLA	Lead
CDBLA455KCAY09-B0	455	fn±5.0 min.	100 min.	1.5 max.	-	NE604N	PHILIPS	Lead
CDBLA455KCAY13A-B0	455	fn±4.0 min.	350 ±50	3.0 max.	-	CXA1003BM	SONY	Lead
CDBLA455KCAY16-B0	455	fn±4.0 min.	185 ±40	2.0 max.	-	MC3372	MOTOROLA	Lead
CDBLA455KCAY24-B0	455	fn±4.0 min.	100 ±40	2.0 max.	-	TA31136	TOSHIBA	Lead
CDBLA455KCAY28-B0	455	fn±4.0 min.	40 ±20	3.0 max.	-	TA31142	TOSHIBA	Lead
CDBLA455KCAY34-B0	455	fn±4.0 min.	65 ±20	2.5 max.	-	MC13136	MOTOROLA	Lead
CDBLA455KCLY09-B0	455	fn±15.0 min.	70 ±20	1.5 max.	3.5 max. [within fn ±8kHz]	NE604N	PHILIPS	Lead
CDBLA455KCLY13-B0	455	fn±15.0 min.	110 ±30	1.5 max.	5.0 max. [within fn ±8kHz]	CXA1003BM	SONY	Lead
CDBLB455KCAY07-B0	455	fn±4.0 min.	340 ±60	3.0 max.	-	MC3357	MOTOROLA	Lead
CDBLB455KCAY13A-B0	455	fn±4.0 min.	350 ±50	3.0 max.	-	CXA1003BM	SONY	Lead

Continued on the following page.

Continued from the preceding page.

Part Number	Nominal Center Frequency (fn) (kHz)	Recovered Audio 3dB BW (kHz)	Recovered Audio Output (mV)	Distortion (at fn) (%)	Distortion (%)	IC	IC Maker	Type
CDBLB455KCAY24-B0	455	fn±4.0 min.	100 ±40	2.0 max.	-	TA31136	TOSHIBA	Lead
CDBLB455KCAY28-B0	455	fn±4.0 min.	40 ±20	3.0 max.	-	TA31142FN	TOSHIBA	Lead
CDBLB455KCAY34-B0	455	fn±4.0 min.	65 ±20	2.5 max.	-	MC13136	MOTOROLA	Lead
CDBLB455KCAY40-B0	455	fn±4.0 min.	40 ±20	3.0 max.	-	TA31145	TOSHIBA	Lead
CDBLB455KCAY42-B0	455	fn±4.0 min.	40 ±15	3.0 max.	-	TK14590 /TK14591	TOKO	Lead
CDBLB455KCAY49-B0	455	fn±4.0 min.	45 ±10	3.0 max.	-	MC3361	MOTOROLA	Lead
CDBLB455KCAY50-B0	455	fn±4.0 min.	64 ±6.4	4.0 max.	-	CXA3117N	SONY	Lead
CDBLB455KCLY09-B0	455	fn±15.0 min.	70 ±20	1.5 max.	3.5 max. [within fn ±8kHz]	NE604N	PHILIPS	Lead
CDBLB455KCLY13-B0	455	fn±15.0 min.	110 ±30	1.5 max.	5.0 max. [within fn ±8kHz]	CXA1003BM	SONY	Lead
CDBLB455KCAX16-B0	455	fn±4.0 min.	185 ±40	2.0 max.	-	MC3372	MOTOROLA	Lead
CDBLB455KCAX18-B0	455	fn±3.0 min.	180 ±40	2.0 max.	-	MC3371	MOTOROLA	Lead
CDBLB455KCAX36-B0	455	fn±3.5 min.	100 ±25	3.5 max.	-	NE606 /616	PHILIPS	Lead

For safety purposes, connect the output of filters to the IF amplifier through a D.C. blocking capacitor. Avoid applying a direct current to the output of ceramic filters. The order quantity should be an integral multiple of the "Minimum Quantity" shown in package page in this catalog.

■ Test Circuit

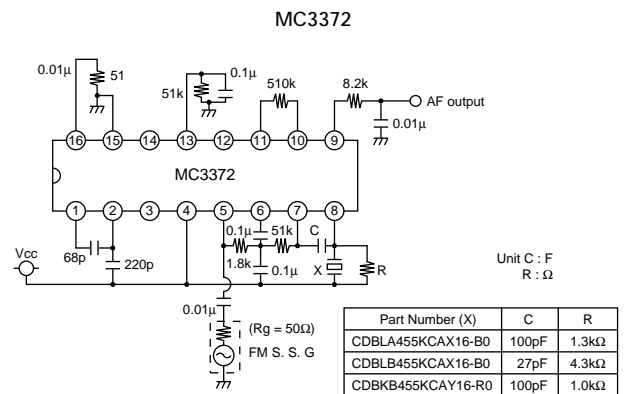
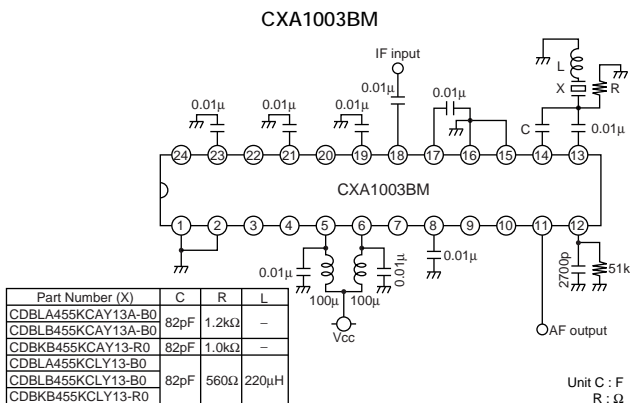
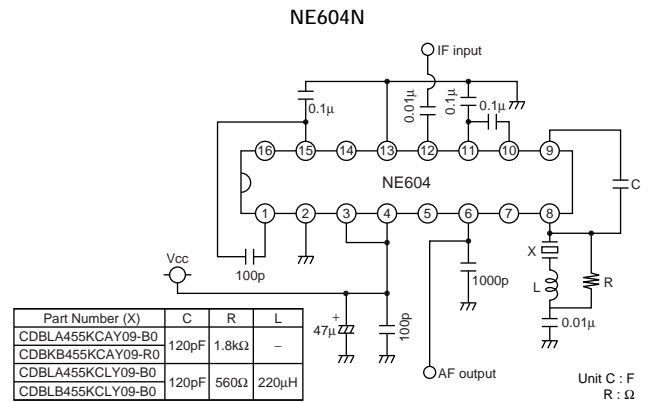
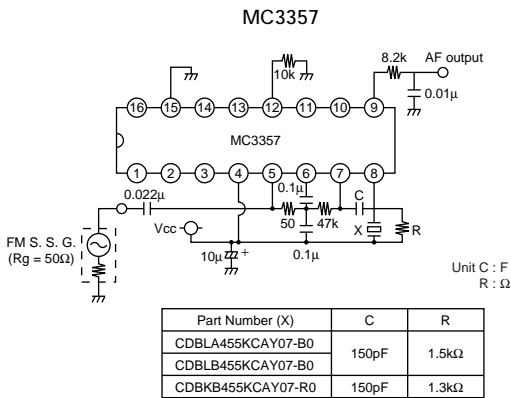

Continued on the following page.

Continued from the preceding page.

Test Circuit

MC3371

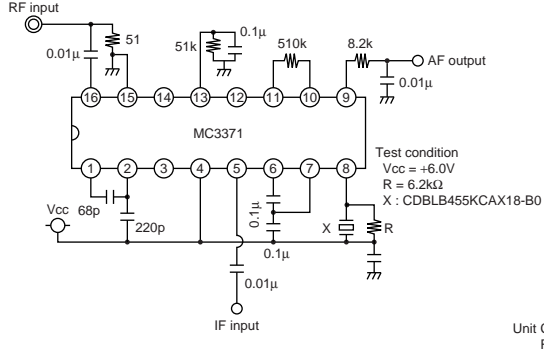

TA31136

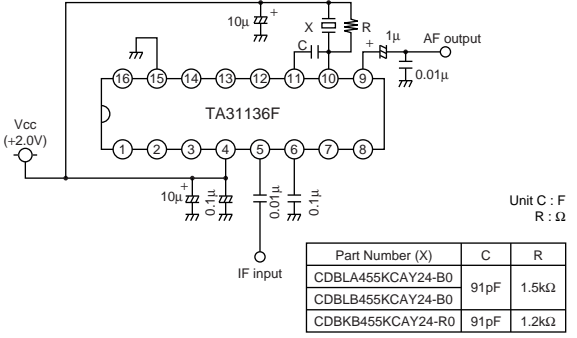

TK10487

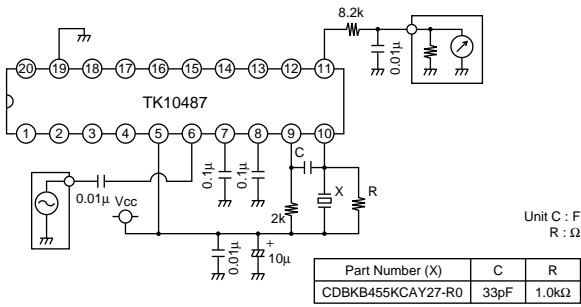

TA31142

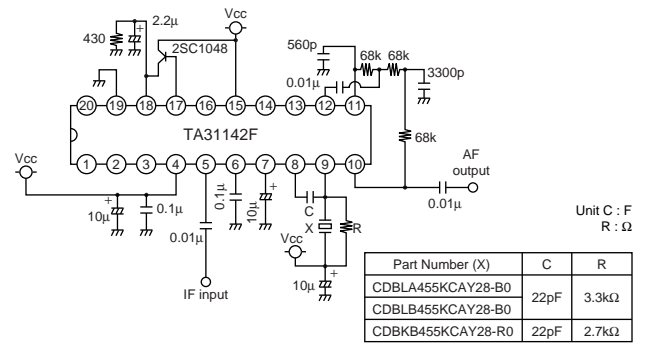

NE605

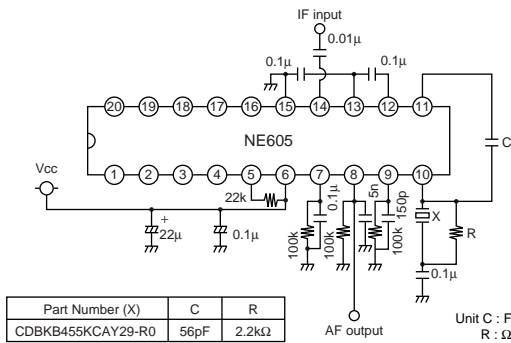

MC13136

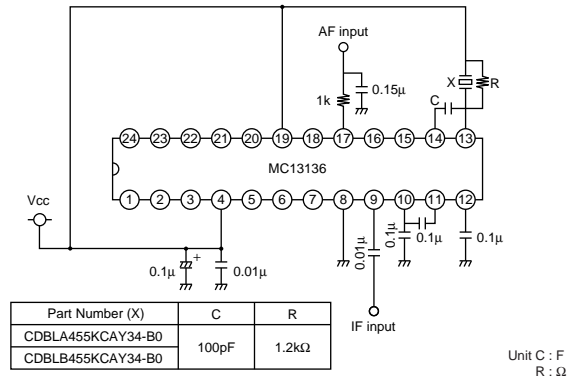

TK10930

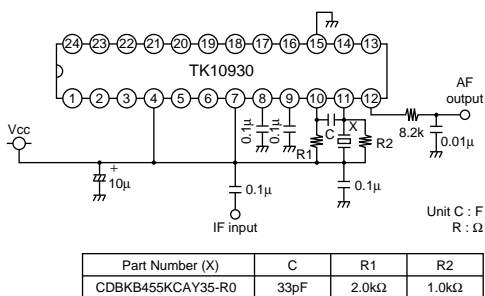

NE(SA)606/616

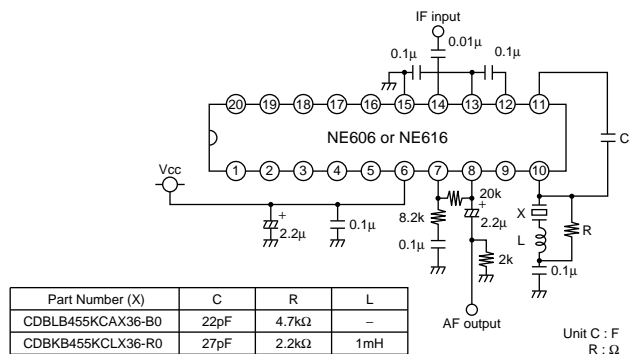

■ Recovered Audio Curve

CDBKB455KCAY07-R0

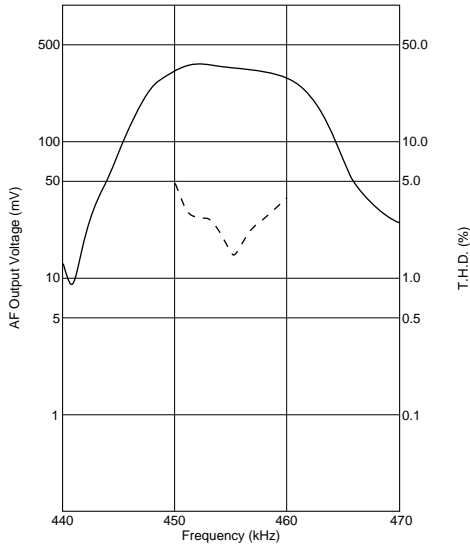

CDBLA/CDBLB455KCAY07-B0

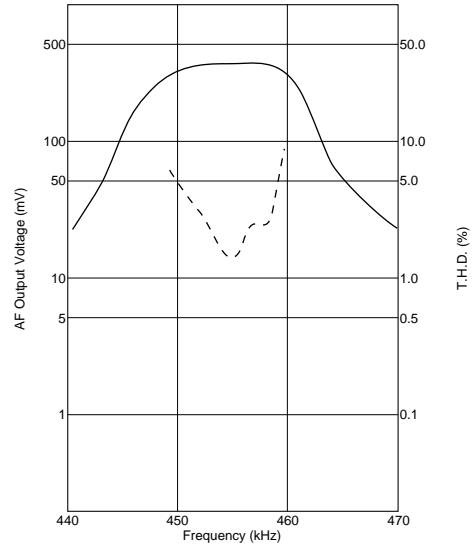

CDBKB455KCAY09-R0

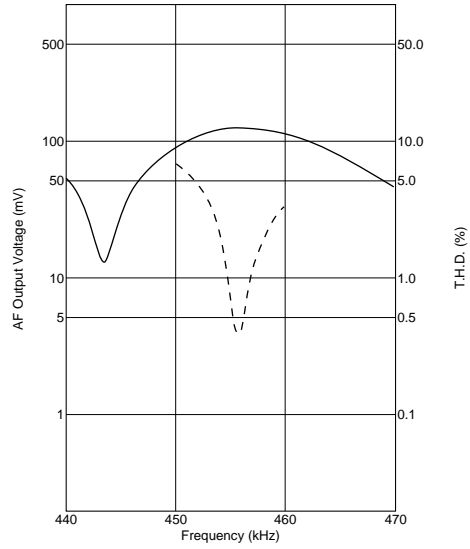

CDBLA455KCAY09-B0

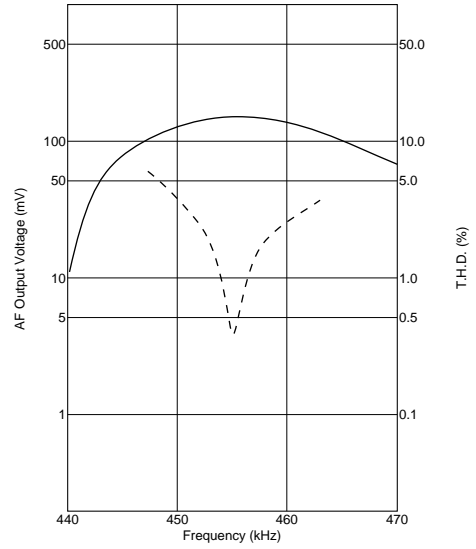

CDBLA/CDBLB455KCLY09-B0

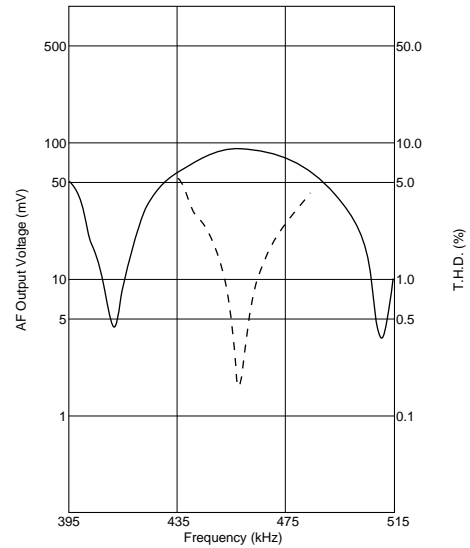

CDBKB455KCAY13-R0

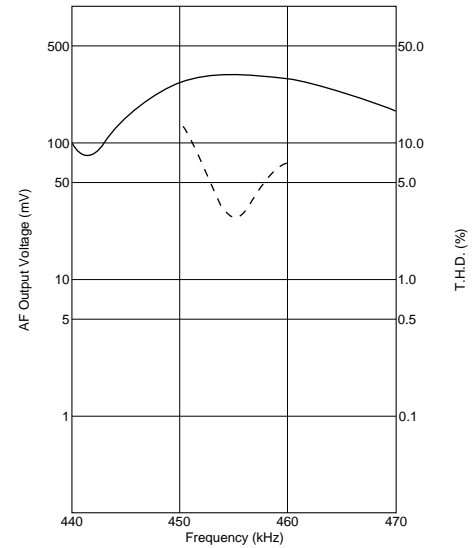

Continued from the preceding page.

Recovered Audio Curve

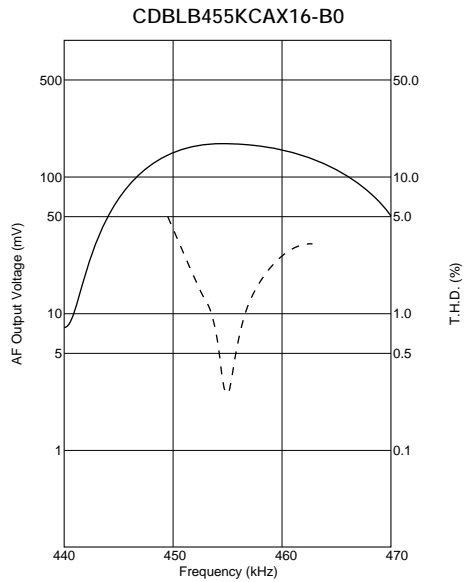
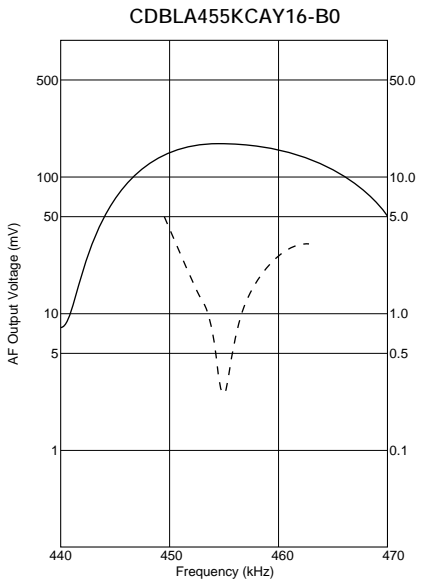
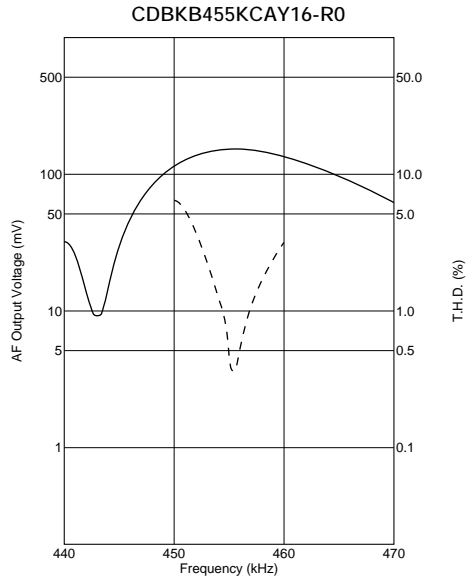
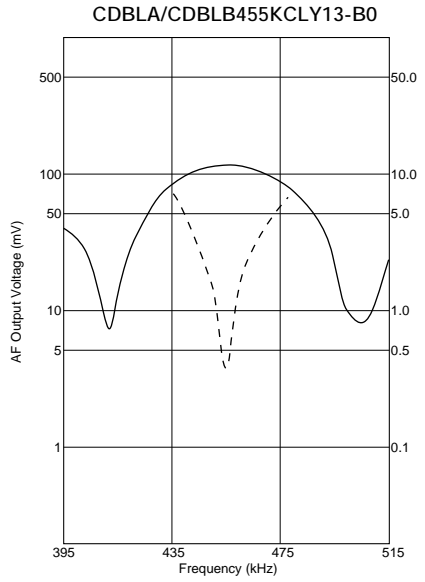
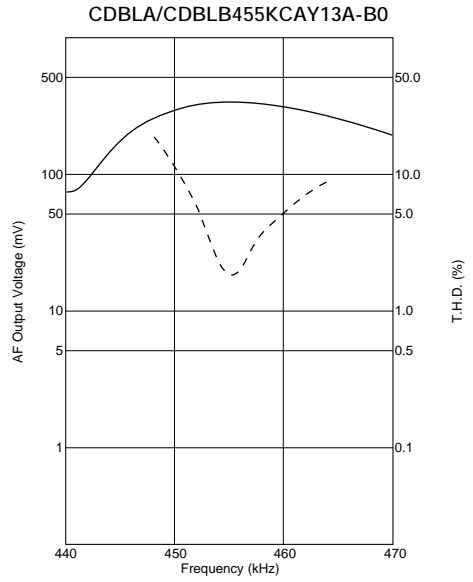
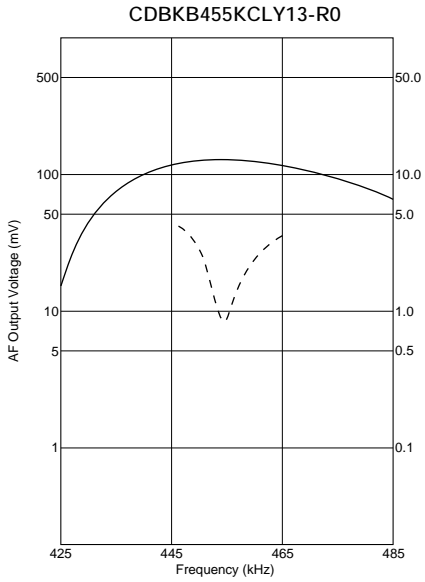

Continued on the following page.

Continued from the preceding page.

Recovered Audio Curve

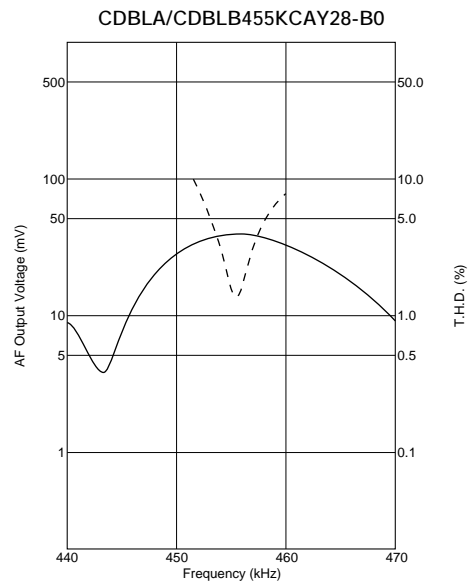
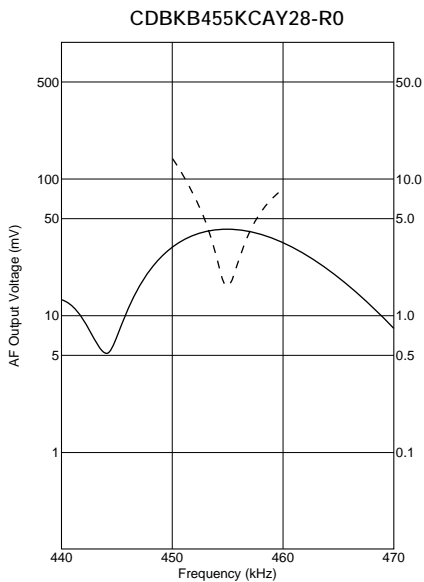
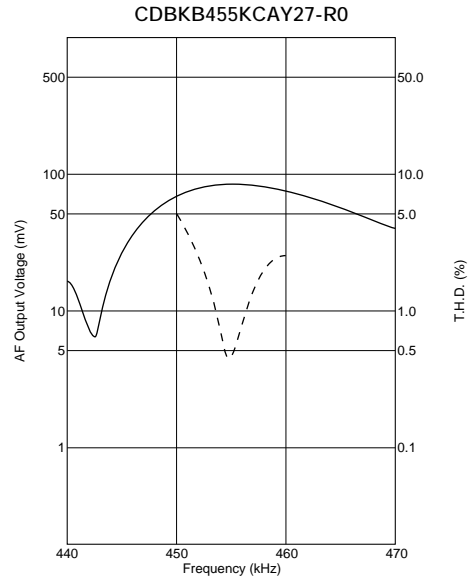
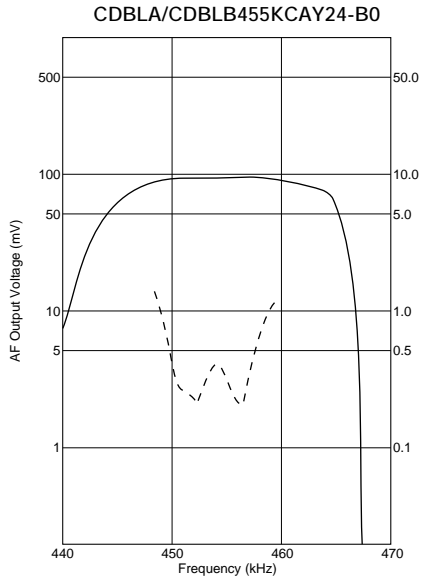
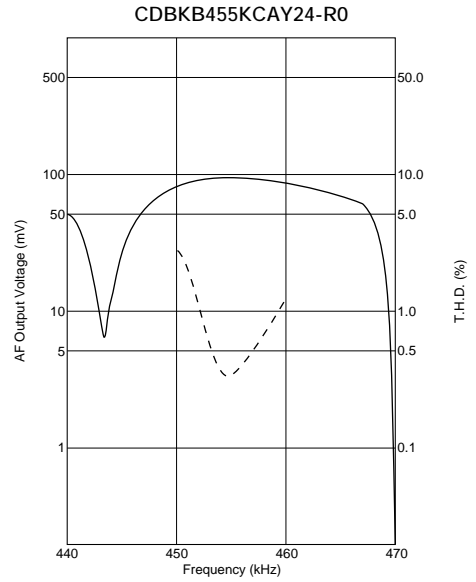
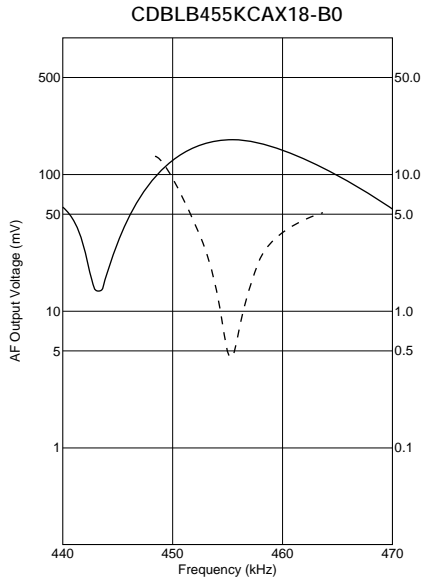

Continued from the preceding page.

Recovered Audio Curve

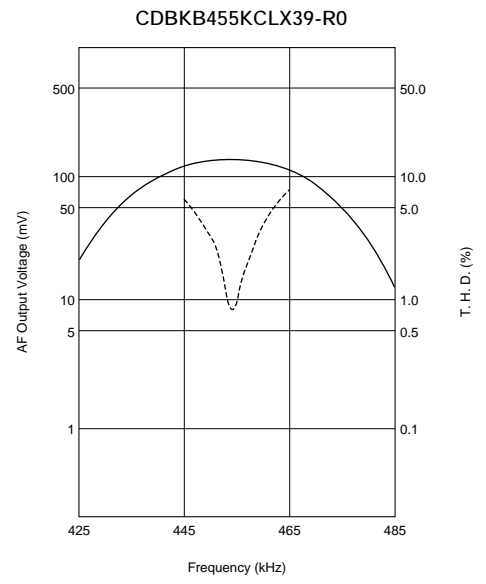
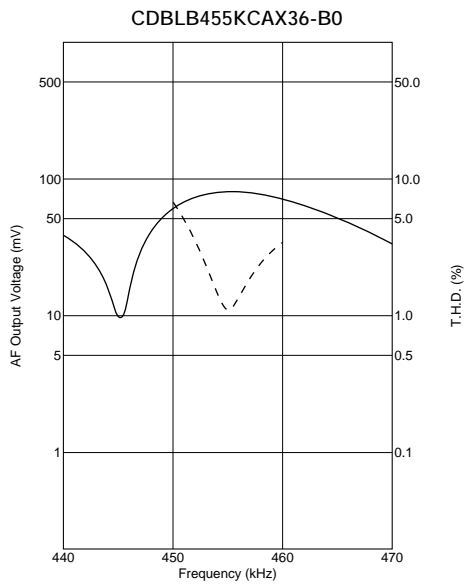
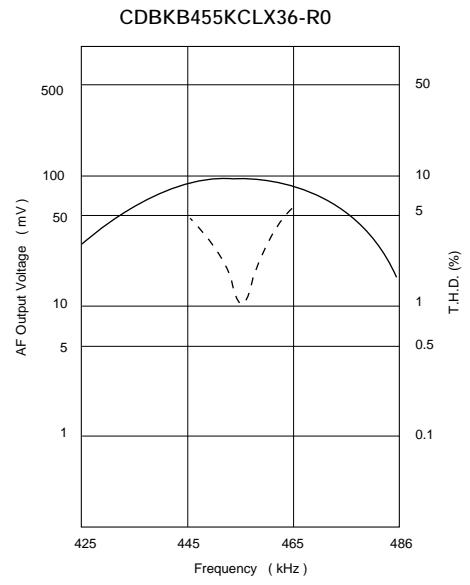
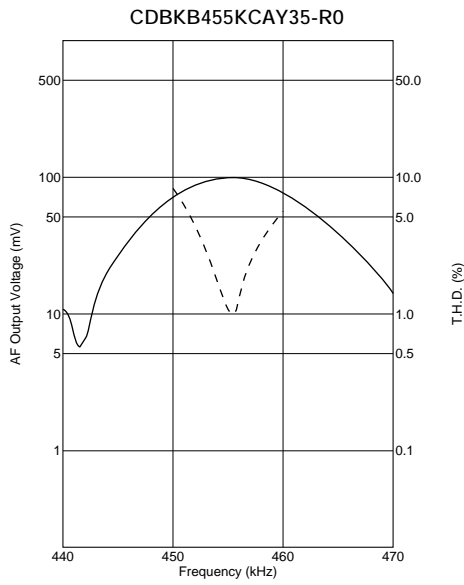
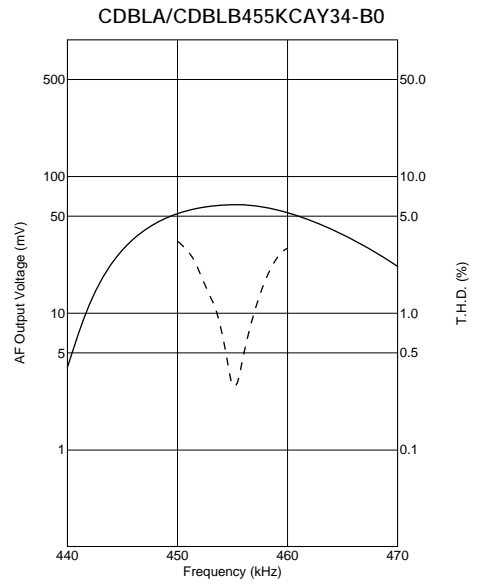
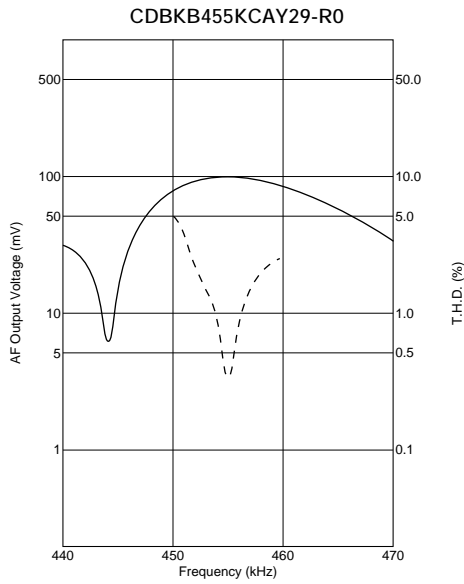

Continued on the following page. ↗

☐ Continued from the preceding page.

■ Recovered Audio Curve

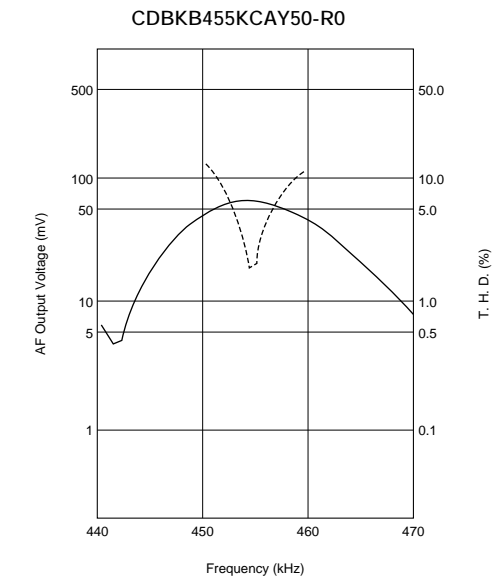
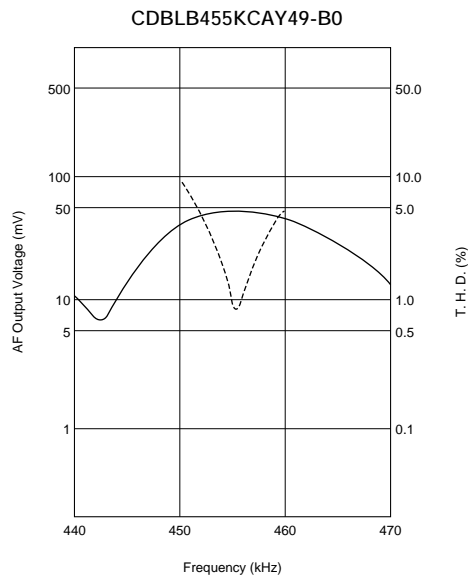
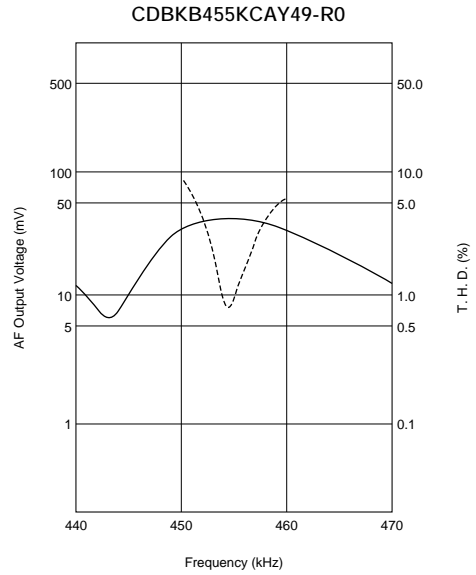
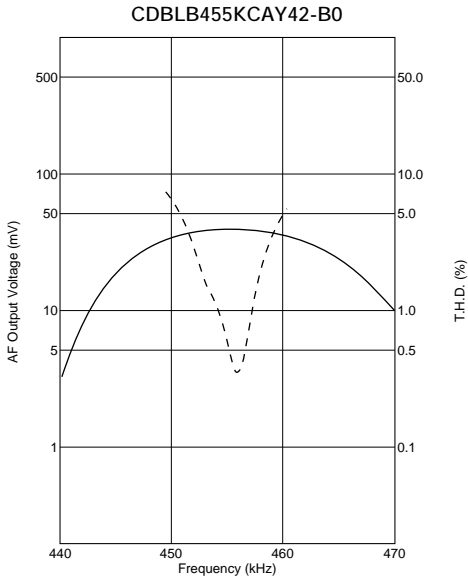
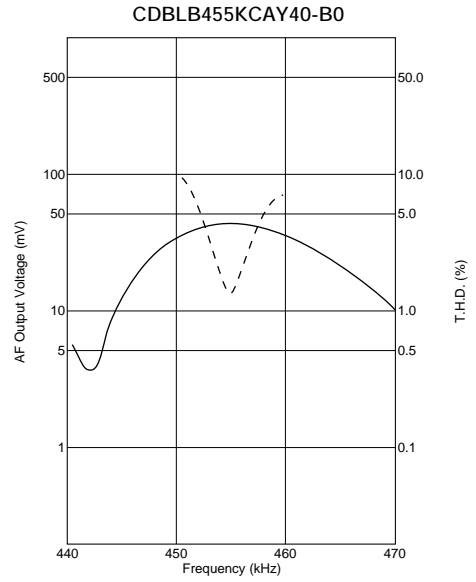
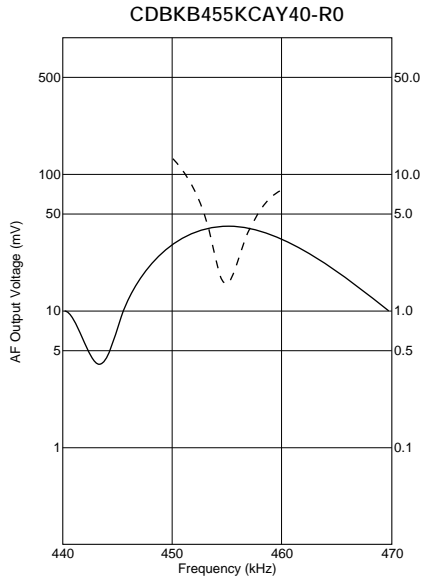

Continued from the preceding page.

Recovered Audio Curve

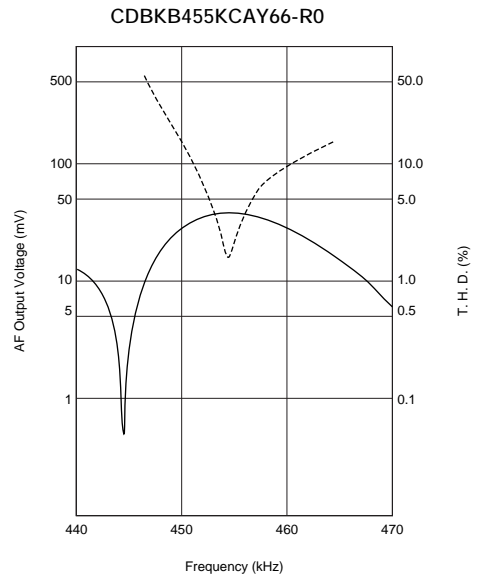
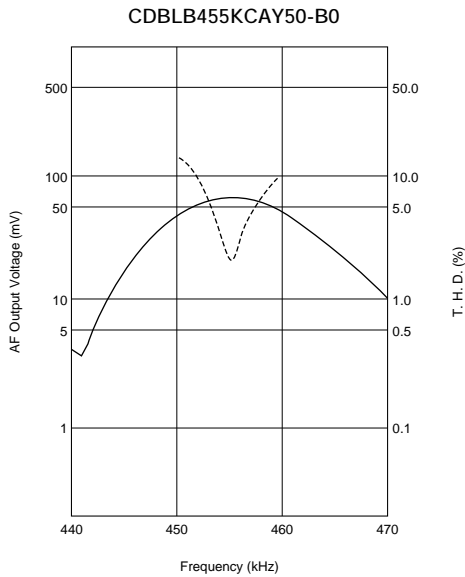

Specified by S Curve Characteristics

Part Number	Nominal Center Frequency (fn) (kHz)	S Curve (1) Output Volt. at fn (mV)	S Curve (2) at fn±4.8kHz (mV)	IC	IC Maker	Type
CDBKB455KCAY54-R0	455	165 ±20	170 ±20	TA31149	TOSHIBA	SMD

For safety purposes, connect the output of filters to the IF amplifier through a D.C. blocking capacitor. Avoid applying a direct current to the output of ceramic filters. The order quantity should be an integral multiple of the "Minimum Quantity" shown in package page in this catalog.

Test Circuit

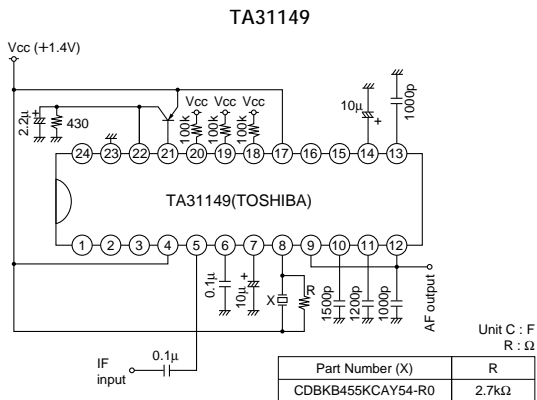

S Curve

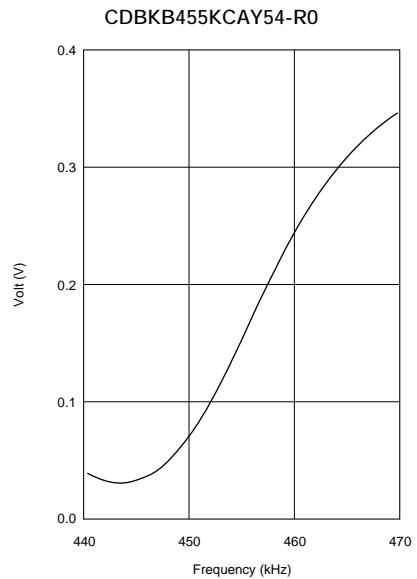

Ceramic Filters (CERAFIL[®])/Ceramic Discriminators for Communications Equipment



MHz Type Ceramic Discriminators

CDSCB10M7 series forms a resonator on a piezoelectric ceramic substrate. In combination with ICs, this type obtains stable demodulation characteristics in a wide bandwidth.
They have 1.0mm max. thickness and small mounting area (4.5x2.0mm).

■ Features

1. Compact and high reliability and recommended for automotive applications.
2. Can be combined with various ICs. The IC is determined by the last number in the part number.
3. Stable demodulation characteristics can be obtained without adjustment.
4. Stable temperature characteristics
5. Recommended for Pb free soldering

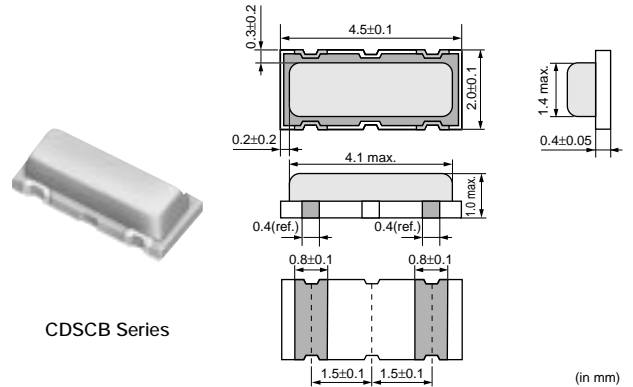

Part Number	Center Frequency (fo) (MHz)	Recovered Audio 3dB BW (kHz)	Recovered Audio Output (mV)	Distortion (%)	IC
CDSCB10M7GA105A-R0	10.700 ±30kHz	220 min.	110 min.	1.5 max.	TEA5757HL
CDSCB10M7GA113-R0	10.700 ±30kHz	300 min.	110 min.	1.0 max.	TA2154FN
CDSCB10M7GA119-R0	10.700 ±30kHz	500 min.	75 min.	1.0 max.	TRF6901
CDSCB10M7GA121-R0	10.700 ±30kHz	390 min.	80 min.	1.0 max.	LV23100V
CDSCB10M7GF072-R0	10.700 (fn)	fn±150 min.	130 min.	2.0 max.	TA31161
CDSCB10M7GF109-R0	10.700 (fn)	fn±100 min.	170 min.	3.0 max.	TK14588V

(fn) means nominal center frequency.

The order quantity should be an integral multiple of the "Minimum Quantity" shown in the package page.

For safety purposes, connect the output of filters to the IF amplifier through a D.C. blocking capacitor. Avoid applying a direct current to the output of ceramic filters.

■ Test Circuit

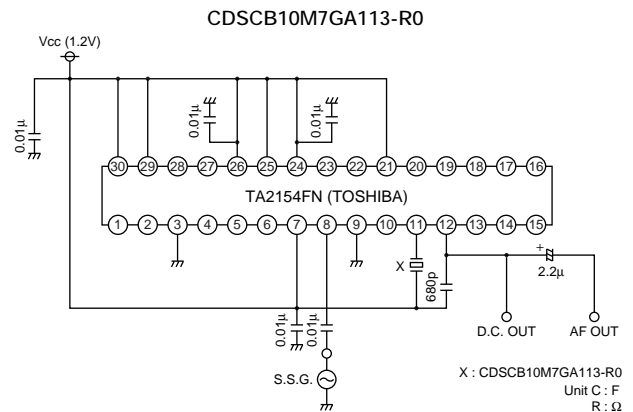
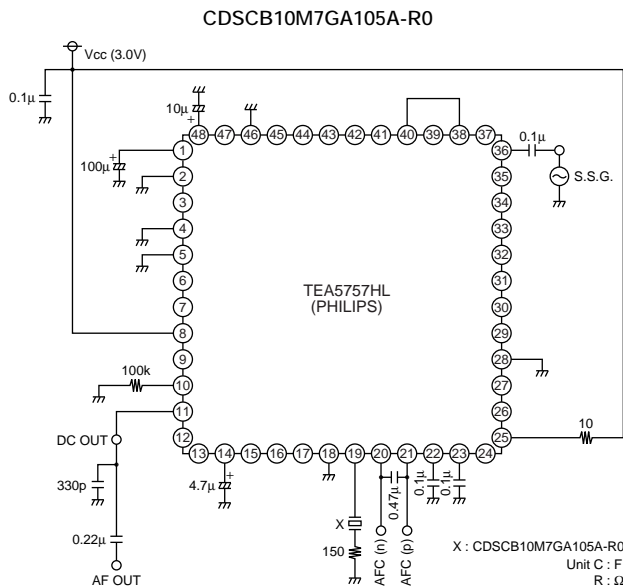

Continued on the following page. ↗

Continued from the preceding page.

Frequency Characteristics

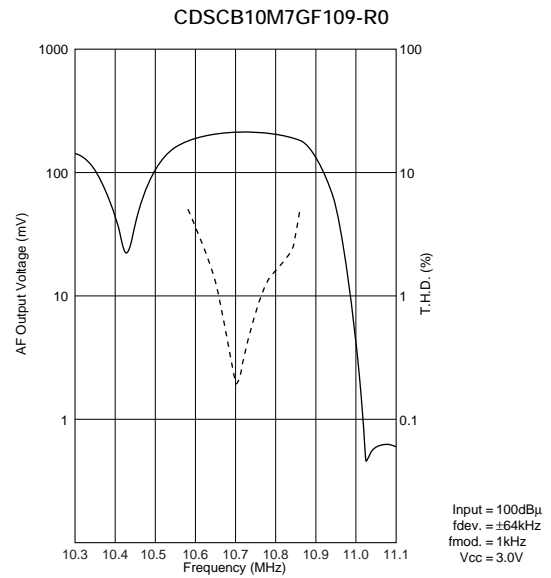
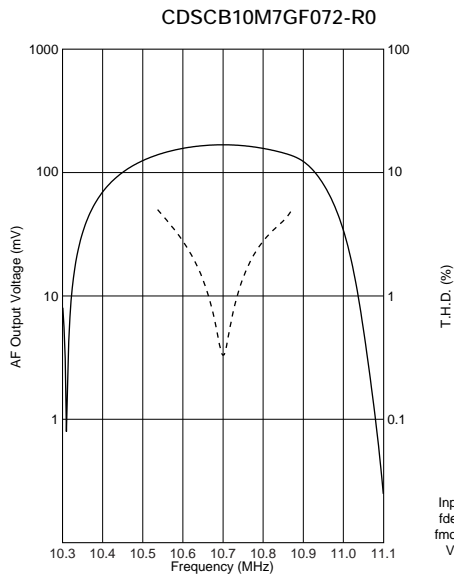
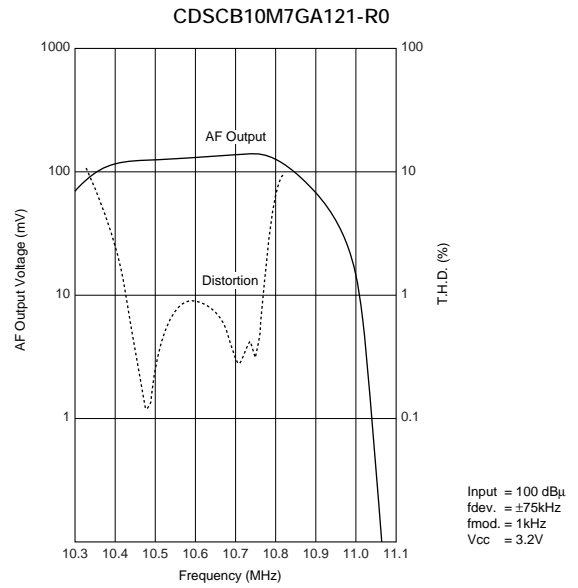
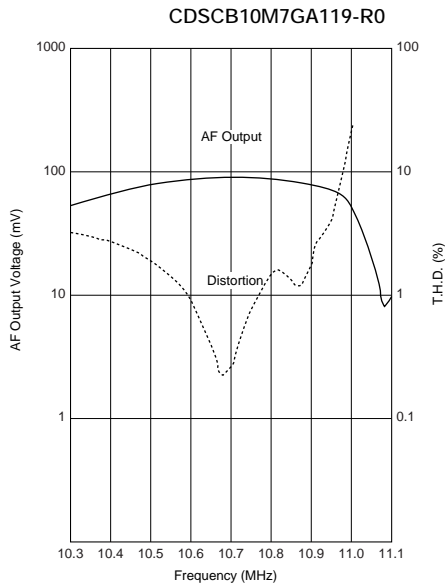

for IF

SAW Filters

● AMPS/ADC

SAFCG130MCA0T00

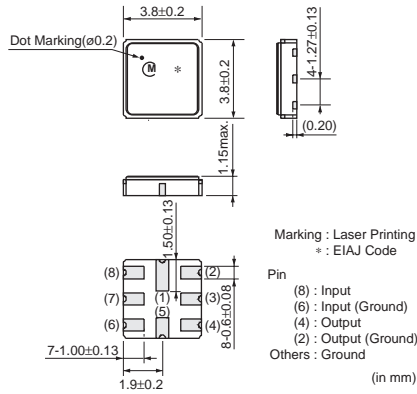

Part Number	Center Frequency (MHz)	3dB Bandwidth (kHz)	Insertion Loss (dB)	Ripple (dB max.)	Input/Output Impedance
SAFCG130MCA0T00	130.380	±630 min.	5.5 max. (at fo point)	-	310ohm//1.6μH (Input) 310ohm//1.6μH (Output)
SAFCT85M3JB0X05	85.380	±12 min.	5.5 max. (at min. loss point)	1.5 (fo±12kHz)	870ohm// -1.8pF (Input) 870ohm// -1.8pF (Output)

7

● DECT

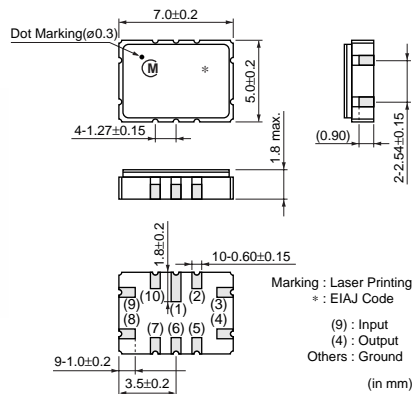

Part Number	Center Frequency (MHz)	3dB Bandwidth (kHz)	Insertion Loss (dB)	Ripple (dB max.)	Input/Output Impedance
SAFCT110MCA1T00	110.592	±576 min.	4.5 max. (at min. loss point)	-	300ohm//1.2μH (Input) 300ohm//1.2μH (Output)

● ETCS

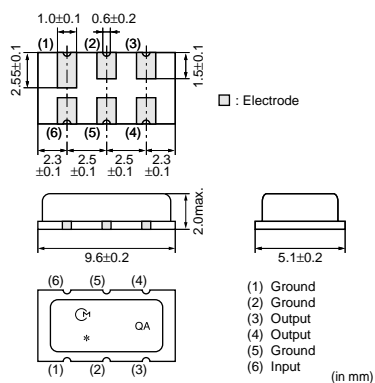

△Note • This catalog has only typical specifications because there is no space for detailed specifications. Therefore, please approve our product specifications or transact the approval sheet for product specifications before ordering. Especially, please read rating and CAUTION (for storage, operating, rating, soldering, mounting and handling) in them to prevent smoking and/or burning, etc.
• You are able to read a detailed specifications in the website (<http://search.murata.co.jp/>) before to require our product specifications or to transact the approval sheet for product specifications.

Part Number	Center Frequency (MHz)	3dB Bandwidth (MHz)	Insertion Loss (dB)	Ripple (dB max.)	Input/Output Impedance
SAFJA40M0WQAZ00R10	40.000	±2.5 min.	21.5 max. (at min. loss point)	-	-

● GPS



SAFCC110MCA1T00

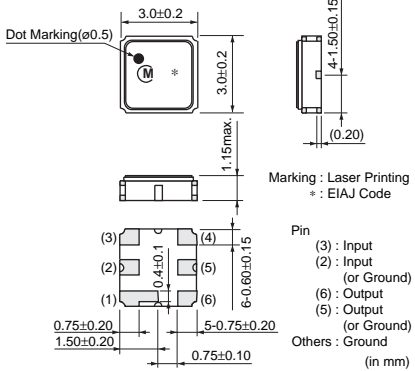

Dot Marking (ø0.5)

Marking : Laser Printing
* : EIAJ Code

Pin
(3) : Input
(2) : Input (or Ground)
(6) : Output
(5) : Output (or Ground)
Others : Ground
(in mm)



SAFJA35M4WC0Z00R03

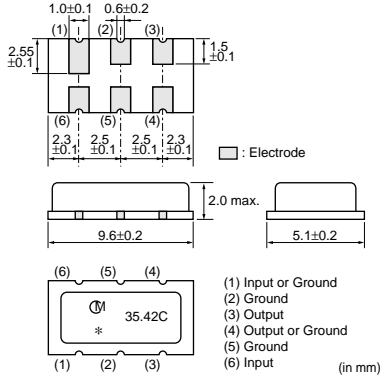

1.0±0.1 0.6±0.2
(1) (2) (3)
2.55±0.1 1.5±0.1
(6) (5) (4)
2.3±0.1 2.5±0.1 2.5±0.1 2.3±0.1
□ : Electrode

2.0 max.
9.6±0.2 5.1±0.2

(6) (5) (4)
35.42C
(1) (2) (3)
(1) Input or Ground
(2) Ground
(3) Output
(4) Output or Ground
(5) Ground
(6) Input
(in mm)

Part Number	Center Frequency (MHz)	3dB Bandwidth (MHz)	Insertion Loss (dB)	Ripple (dB max.)	Input/Output Impedance
SAFCC110MCA1T00	110.0	±1.023 min.	3.7 max. (at min. loss point)	0.6	480ohm// -1.6μH (Input) 650ohm// -1.6μH (Output)
SAFJA35M4WC0Z00R03	35.42 (fn)	1.90 min. (1dB Bandwidth)	20.5 max. (at fn)	1.6 (within 34.62 to 36.22MHz)	14.3k ohm//5.1pF (Input) 4.0k ohm//5.1pF (Output)

● GSM



SAFCC225MRA0X00

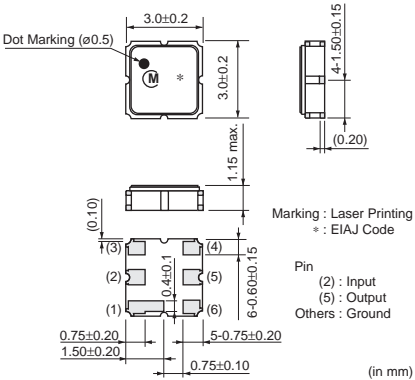

Dot Marking (ø0.5)

Marking : Laser Printing
* : EIAJ Code

Pin
(2) : Input
(5) : Output
Others : Ground
(in mm)

Part Number	Center Frequency (MHz)	3dB Bandwidth (kHz)	Insertion Loss (dB)	Ripple (dB max.)	Input/Output Impedance
SAFCC225MRA0X00	225.000	±80 min.	9.0 max. (at min. loss point)	1.5 (f0±80kHz)	1100ohm// -0.42pF (Input) 900ohm// -0.30pF (Output)
SAFCC282MRA0X01	282.000	±80 min.	9.0 max. (at min. loss point)	1.5 (f0±80kHz)	1000ohm// -0.34pF (Input) 860ohm// -0.34pF (Output)

△Note • This catalog has only typical specifications because there is no space for detailed specifications. Therefore, please approve our product specifications or transact the approval sheet for product specifications before ordering. Especially, please read rating and △CAUTION (for storage, operating, rating, soldering, mounting and handling) in them to prevent smoking and/or burning, etc.
• You are able to read a detailed specifications in the website (<http://search.murata.co.jp/>) before to require our product specifications or to transact the approval sheet for product specifications.

● PHS



SAFDA243MRD9X00

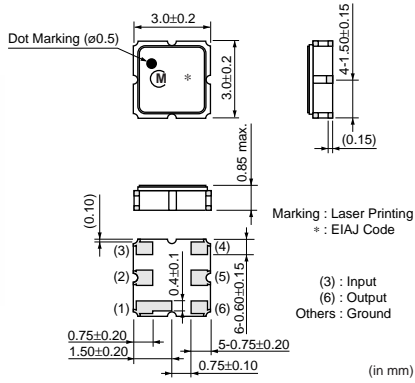

SAFCC243MRB9X00

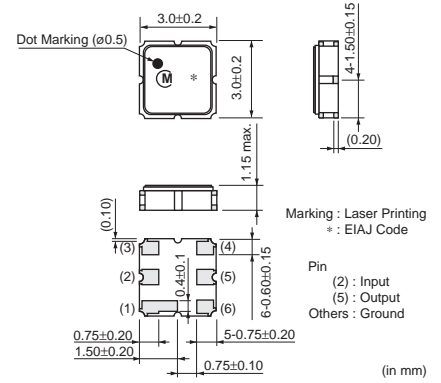

Part Number	Center Frequency (MHz)	3dB Bandwidth (kHz)	Insertion Loss (dB)	Ripple (dB max.)	Input/Output Impedance
SAFDA243MRD9X00	243.950	±130 min.	4.5 max. (at fo point)	1.0 (fo±100kHz)	760ohm// -1.0pF (Input) 760ohm// -0.8pF (Output)
SAFCC243MRB9X00	243.950	±130 min.	4.5 max. (at min. loss point)	1.0 (fo±100kHz)	760ohm// -1.0pF (Input) 760ohm// -0.8pF (Output)
SAFCC265MRB5X01	265.550	±130 min.	4.5 max. (at fo point)	1.0 (fo±100kHz)	740ohm// -1.0pF (Input) 820ohm// -0.9pF (Output)

● W-CDMA

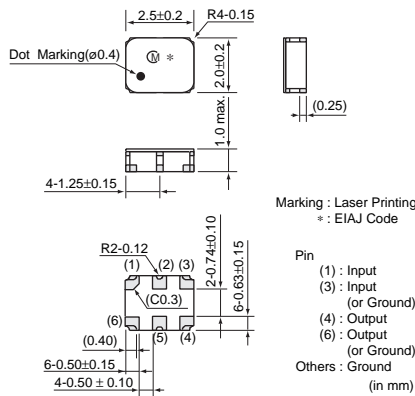

Part Number	Center Frequency (MHz)	3dB Bandwidth (MHz)	Insertion Loss (dB)	Ripple (dB max.)	Input/Output Impedance
SAFSD570MCM0T00	570	±2.5 min.	3.5 max. (at fo point)	0.8 (fo±1.92MHz)	310ohm//120nH (Input) 310ohm//120nH (Output)

● Wireless LAN

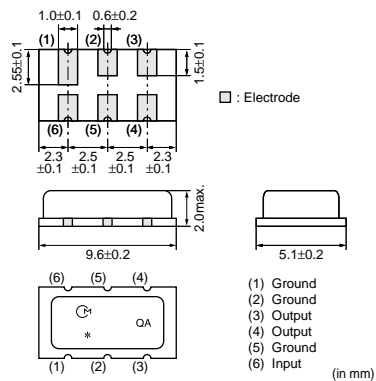

△Note • This catalog has only typical specifications because there is no space for detailed specifications. Therefore, please approve our product specifications or transact the approval sheet for product specifications before ordering. Especially, please read rating and △CAUTION (for storage, operating, rating, soldering, mounting and handling) in them to prevent smoking and/or burning, etc.
• You are able to read a detailed specifications in the website (<http://search.murata.co.jp/>) before to require our product specifications or to transact the approval sheet for product specifications.

Part Number	Center Frequency (MHz)	3dB Bandwidth (MHz)	Insertion Loss (dB)	Ripple (dB max.)	Input/Output Impedance
SAFJA43M0WC0Z00R03	43.00 ±0.1MHz (fo)	1.25 min.	21.0 max. (at fo point)	-	-

● 5G W-LAN

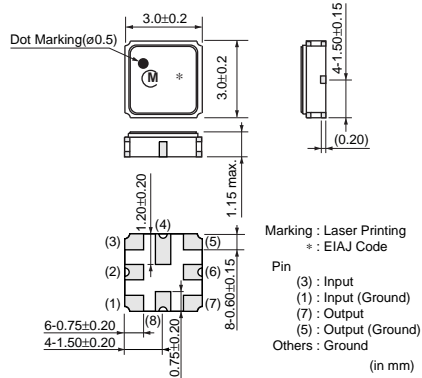

Part Number	Center Frequency (MHz)	3dB Bandwidth (MHz)	Insertion Loss (dB)	Ripple (dB max.)	Input/Output Impedance
SAFCD450MCL0N00	450	±8.2 min.	4.5 max. (at min. loss point)	1.5 (fo±8.2MHz)	200ohm//150nH (Input) 200ohm//150nH (Output)
SAFCD570MCL0N00	570	±8.5 min. (2dB Bandwidth)	7.0 max. (fo±8.5MHz)	2.0 (fo±8.5MHz)	200ohm//100nH (Input) 200ohm//100nH (Output)

△Note • This catalog has only typical specifications because there is no space for detailed specifications. Therefore, please approve our product specifications or transact the approval sheet for product specifications before ordering. Especially, please read rating and △CAUTION (for storage, operating, rating, soldering, mounting and handling) in them to prevent smoking and/or burning, etc.
• You are able to read a detailed specifications in the website (<http://search.murata.co.jp/>) before to require our product specifications or to transact the approval sheet for product specifications.

for IF

Chip LC Filters (Balance-balance Type)

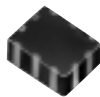

LFB32130MSH3A569

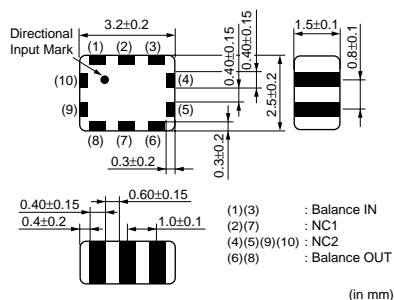

(in mm)
 *Terminal of "NC1" should be fixed to the no connected pattern.
 Terminal of "NC2" should not be fixed to any pattern.
 All the technical data and Information contained herein are subject to change without prior notice.

Part Number	Nominal Center Frequency (fo) (MHz)	Bandwidth (BW) (MHz)	Insertion Loss in BW (dB)	Input Balance Impedance (Differential) (Nom.) (ohm)	Output Balance Impedance (Differential) (Nom.) (ohm)
LFB32130MSH3A569	130.38	fo±0.7	5.0 max. (at 25°C)	1000	250
LFB32166MSH2A570	166.85	fo±0.65	5.0 max. (at 25°C)	300	300

for IF

Chip LC Filters (Balance-unbalance Type)

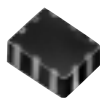

LFB32130MSQ1A552

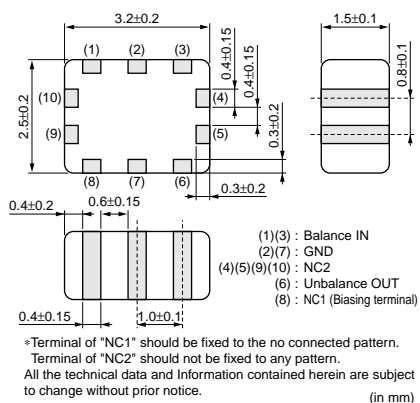

(in mm)
 *Terminal of "NC1" should be fixed to the no connected pattern.
 Terminal of "NC2" should not be fixed to any pattern.
 All the technical data and Information contained herein are subject to change without prior notice.

Part Number	Nominal Center Frequency (fo) (MHz)	Bandwidth (BW) (MHz)	Insertion Loss in BW (dB)	Balance Impedance (Differential) (Nom.) (ohm)	Unbalance Impedance (Nom.) (ohm)
LFB32130MSQ1A552	130.38	fo±0.65	5.5 max. (at 25°C)	1000	50
LFB32166MSQ1A527	166.85	fo±0.7	4.0 max. (at 25°C)	200	50

Note • This catalog has only typical specifications because there is no space for detailed specifications. Therefore, please approve our product specifications or transact the approval sheet for product specifications before ordering. Especially, please read rating and CAUTION (for storage, operating, rating, soldering, mounting and handling) in them to prevent smoking and/or burning, etc.
 • You are able to read a detailed specifications in the website (<http://search.murata.co.jp/>) before to require our product specifications or to transact the approval sheet for product specifications.