



## Definition

H.323 is a standard that specifies the components, protocols and procedures that provide multimedia communication services—real-time audio, video, and data communications—over packet networks, including Internet protocol (IP)–based networks. H.323 is part of a family of ITU–T recommendations called H.32x that provides multimedia communication services over a variety of networks.

## Overview

This tutorial discusses the H.323 protocol standard. H.323 is explained with an emphasis on gateways and gatekeepers, which are components of an H.323 network. The call flows between entities in an H.323 network are explained, and the interworking aspects of H.323 with H.32x family protocols are discussed.

## Topics

1. What Is H.323?
  2. H.323 Components
  3. H.323 Zone
  4. Protocols Specified by H.323
  5. Terminal Characteristics
  6. Hardware Platform
  7. H.225 Registration, Admission, and Status
  8. H.225 Signaling and H.245 Control Signaling
  9. Connection Procedures
  10. Interworking with Other Multimedia Networks
- Self-Test
- Correct Answers
- Glossary

# 1. What Is H.323?

The H.323 standard is a cornerstone technology for the transmission of real-time audio, video, and data communications over packet-based networks. It specifies the components, protocols, and procedures providing multimedia communication over packet-based networks (see *Figure 1*). Packet-based networks include IP-based (including the Internet) or Internet packet exchange (IPX)-based local-area networks (LANs), enterprise networks (ENs), metropolitan-area networks (MANs), and wide-area networks (WANs). H.323 can be applied in a variety of mechanisms—audio only (IP telephony); audio and video (videotelephony); audio and data; and audio, video and data. H.323 can also be applied to multipoint-multimedia communications. H.323 provides myriad services and, therefore, can be applied in a wide variety of areas—consumer, business, and entertainment applications.

Figure 1. H.323 Terminals on a Packet Network

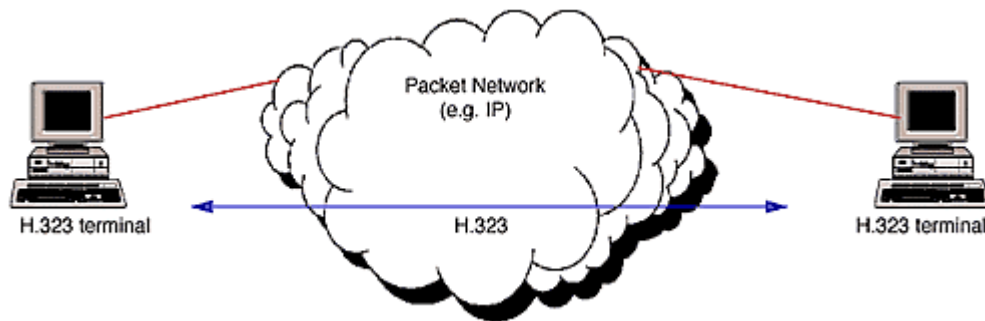

## H.323 Versions

The H.323 standard is specified by the ITU-T Study Group 16. Version 1 of the H.323 recommendation—visual telephone systems and equipment for LANs that provide a nonguaranteed quality of service (QoS)—was accepted in October 1996. It was, as the name suggests, heavily weighted towards multimedia communications in a LAN environment. Version 1 of the H.323 standard does not provide guaranteed QoS.

The emergence of voice-over-IP (VoIP) applications and IP telephony has paved the way for a revision of the H.323 specification. The absence of a standard for voice over IP resulted in products that were incompatible. With the development of VoIP, new requirements emerged, such as providing communication between a PC-based phone and a phone on a traditional switched circuit network (SCN). Such requirements forced the need for a standard for IP telephony. Version 2 of H.323—packet-based multimedia communications systems—was defined to accommodate these additional requirements and was accepted in January 1998.

New features are being added to the H.323 standard, which will evolve to Version 3 shortly. The features being added include fax-over-packet networks, gatekeeper-gatekeeper communications, and fast-connection mechanisms.

## H.323 in Relation to Other Standards of the H.32x Family

The H.323 standard is part of the H.32x family of recommendations specified by ITU-T. The other recommendations of the family specify multimedia communication services over different networks:

- H.324 over SCN
- H.320 over integrated services digital networks (ISDN)
- H.321 and H.310 over broadband integrated services digital networks (B-ISDN)
- H.322 over LANs that provide guaranteed QoS

One of the primary goals in the development of the H.323 standard was interoperability with other multimedia-services networks. This interoperability is achieved through the use of a gateway. A gateway performs any network or signaling translation required for interoperability. Gateways are explained in detail in *Topic 6*.

## 2. H.323 Components

The H.323 standard specifies four kinds of components, which, when networked together, provide the point-to-point and point-to-multipoint multimedia-communication services:

1. terminals
2. gateways
3. gatekeepers
4. multipoint control units (MCUs)

### Terminals

Used for real-time bidirectional multimedia communications, an H.323 terminal can either be a personal computer (PC) or a stand-alone device, running an H.323 and the multimedia applications. It supports audio communications and

can optionally support video or data communications. Because the basic service provided by an H.323 terminal is audio communications, an H.323 terminal plays a key role in IP–telephony services. An H.323 terminal can either be a PC or a stand-alone device, running an H.323 stack and multimedia applications. The primary goal of H.323 is to interwork with other multimedia terminals. H.323 terminals are compatible with H.324 terminals on SCN and wireless networks, H.310 terminals on B–ISDN, H.320 terminals on ISDN, H.321 terminals on B–ISDN, and H.322 terminals on guaranteed QoS LANs. H.323 terminals may be used in multipoint conferences.

## Gateways

A gateway connects two dissimilar networks. An H.323 gateway provides connectivity between an H.323 network and a non–H.323 network. For example, a gateway can connect and provide communication between an H.323 terminal and SCN networks (SCN networks include all switched telephony networks, e.g., public switched telephone network [PSTN]). This connectivity of dissimilar networks is achieved by translating protocols for call setup and release, converting media formats between different networks, and transferring information between the networks connected by the gateway. A gateway is not required, however, for communication between two terminals on an H.323 network.

## Gatekeepers

A gatekeeper can be considered the brain of the H.323 network. It is the focal point for all calls within the H.323 network. Although they are not required, gatekeepers provide important services such as addressing, authorization and authentication of terminals and gateways; bandwidth management; accounting; billing; and charging. Gatekeepers may also provide call-routing services.

## Multipoint Control Units

MCUs provide support for conferences of three or more H.323 terminals. All terminals participating in the conference establish a connection with the MCU. The MCU manages conference resources, negotiates between terminals for the purpose of determining the audio or video coder/decoder (CODEC) to use, and may handle the media stream. The gatekeepers, gateways, and MCUs are logically separate components of the H.323 standard but can be implemented as a single physical device.

### 3. H.323 Zone

An H.323 zone is a collection of all terminals, gateways, and MCUs managed by a single gatekeeper (see *Figure 2*). A zone includes at least one terminal and may include gateways or MCUs. A zone has only one gatekeeper. A zone may be independent of network topology and may be comprised of multiple network segments that are connected using routers or other devices.

Figure 2. An H.323 Zone

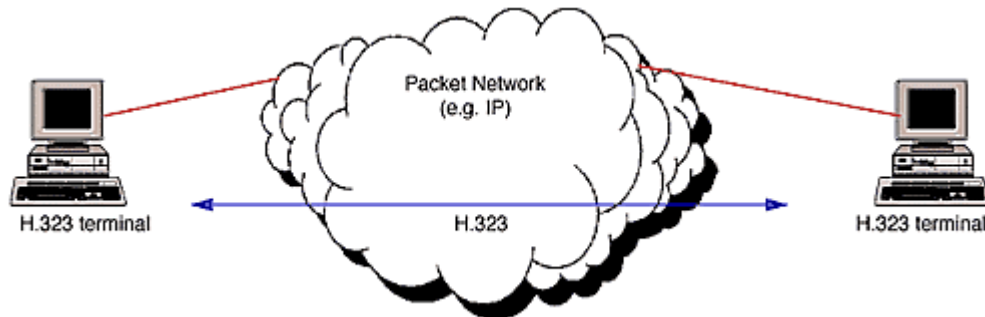

### 4. Protocols Specified by H.323

The protocols specified by H.323 are listed below. H.323 is independent of the packet network and the transport protocols over which it runs and does not specify them (see *Figure 3*).

- audio CODECs
- video CODECs
- H.225 registration, admission, and status (RAS)
- H.225 call signaling
- H.245 control signaling
- real-time transfer protocol (RTP)
- real-time control protocol (RTCP)

Figure 3. H.323 Terminal-Side Protocol Stack

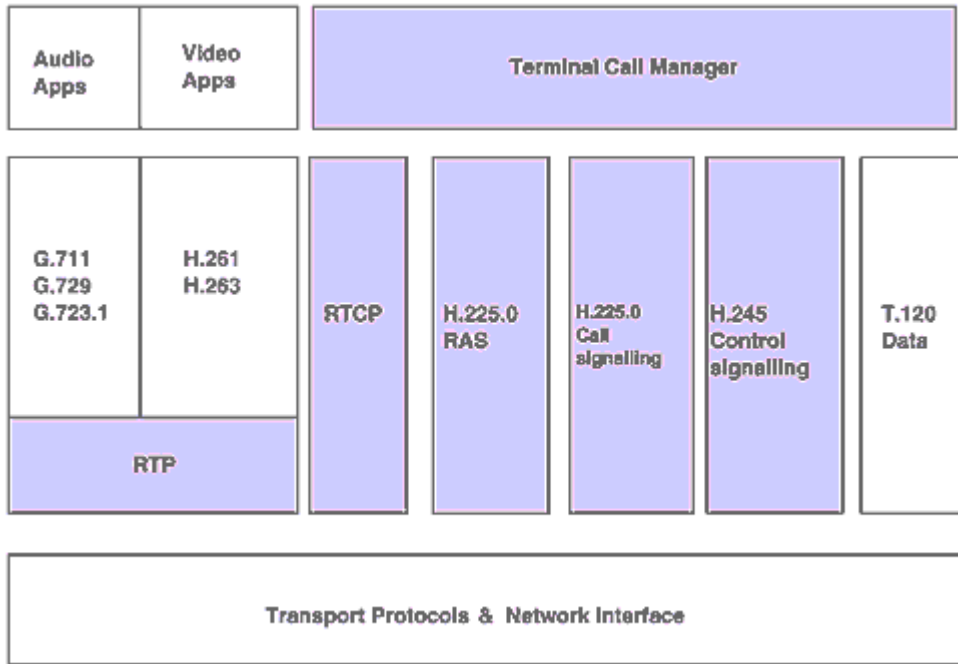

## Audio CODEC

An audio CODEC encodes the audio signal from the microphone for transmission on the transmitting H.323 terminal and decodes the received audio code that is sent to the speaker on the receiving H.323 terminal. Because audio is the minimum service provided by the H.323 standard, all H.323 terminals must have at least one audio CODEC support, as specified in the ITU–T G.711 recommendation (audio coding at 64 kbps). Additional audio CODEC recommendations such as G.722 (64, 56, and 48 kbps), G.723.1 (5.3 and 6.3 kbps), G.728 (16 kbps), and G.729 (8 kbps) may also be supported.

## Video CODEC

A video CODEC encodes video from the camera for transmission on the transmitting H.323 terminal and decodes the received video code that is sent to the video display on the receiving H.323 terminal. Because H.323 specifies support of video as optional, the support of video CODECs is optional as well. However, any H.323 terminal providing video communications must support video encoding and decoding as specified in the ITU–T H.261 recommendation.

## H.225 Registration, Admission, and Status

Registration, admission, and status (RAS) is the protocol between endpoints (terminals and gateways) and gatekeepers. The RAS is used to perform registration, admission control, bandwidth changes, status, and disengage procedures between endpoints and gatekeepers. An RAS channel is used to exchange RAS messages. This signaling channel is opened between an endpoint and a gatekeeper prior to the establishment of any other channels.

## H.225 Call Signaling

The H.225 call signaling is used to establish a connection between two H.323 endpoints. This is achieved by exchanging H.225 protocol messages on the call-signaling channel. The call-signaling channel is opened between two H.323 endpoints or between an endpoint and the gatekeeper.

## H.245 Control Signaling

H.245 control signaling is used to exchange end-to-end control messages governing the operation of the H.323 endpoint. These control messages carry information related to the following:

- capabilities exchange
- opening and closing of logical channels used to carry media streams
- flow-control messages
- general commands and indications

## Real-Time Transport Protocol

Real-time transport protocol (RTP) provides end-to-end delivery services of real-time audio and video. Whereas H.323 is used to transport data over IP-based networks, RTP is typically used to transport data via the user datagram protocol (UDP). RTP, together with UDP, provides transport-protocol functionality. RTP provides payload-type identification, sequence numbering, timestamping, and delivery monitoring. UDP provides multiplexing and checksum services. RTP can also be used with other transport protocols.

## Real-Time Transport Control Protocol

Real-time transport control protocol (RTCP) is the counterpart of RTP that provides control services. The primary function of RTCP is to provide feedback

on the quality of the data distribution. Other RTCP functions include carrying a transport-level identifier for an RTP source, called a canonical name, which is used by receivers to synchronize audio and video.

## 5. Terminal Characteristics

H.323 terminals must support the following:

- H.245 for exchanging terminal capabilities and creation of media channels
- H.225 for call signaling and call setup
- RAS for registration and other admission control with a gatekeeper
- RTP/RTCP for sequencing audio and video packets

H.323 terminals must also support the G.711 audio CODEC. Optional components in an H.323 terminal are video CODECs, T.120 data-conferencing protocols, and MCU capabilities.

## 6. Gateway and Gatekeeper Characteristics

### Gateway Characteristics

A gateway provides translation of protocols for call setup and release, conversion of media formats between different networks, and the transfer of information between H.323 and non-H.323 networks (see *Figure 4*). An application of the H.323 gateway is in IP telephony, where the H.323 gateway connects an IP network and SCN network (e.g., ISDN network).



Figure 4. Gateway Protocol Stack

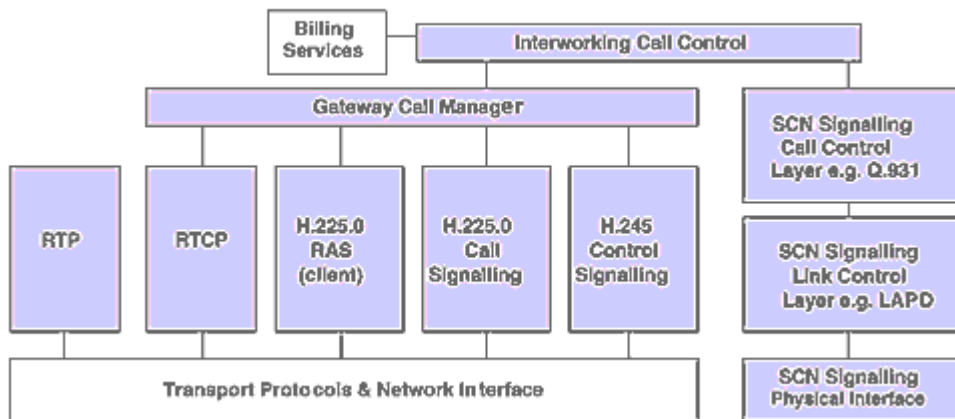

On the H.323 side, a gateway runs H.245 control signaling for exchanging capabilities, H.225 call signaling for call setup and release, and H.225 registration, admissions, and status (RAS) for registration with the gatekeeper. On the SCN side, a gateway runs SCN-specific protocols (e.g., ISDN and SS7 protocols).

Terminals communicate with gateways using the H.245 control-signaling protocol and H.225 call-signaling protocol. The gateway translates these protocols in a transparent fashion to the respective counterparts on the non-H.323 network and vice versa. The gateway also performs call setup and clearing on both the H.323-network side and the non-H.323-network side. Translation between audio, video, and data formats may also be performed by the gateway. Audio and video translation may not be required if both terminal types find a common communications mode. For example, in the case of a gateway to H.320 terminals on the ISDN, both terminal types require G.711 audio and H.261 video, so a common mode always exists. The gateway has the characteristics of both an H.323 terminal on the H.323 network and the other terminal on the non-H.323 network it connects.

Gatekeepers are aware of which endpoints are gateways because this is indicated when the terminals and gateways register with the gatekeeper. A gateway may be able to support several simultaneous calls between the H.323 and non-H.323 networks. In addition, a gateway may connect an H.323 network to a non-H.323 network. A gateway is a logical component of H.323 and can be implemented as part of a gatekeeper or an MCU.

## Gatekeeper Characteristics

Gatekeepers provide call-control services for H.323 endpoints, such as address translation and bandwidth management as defined within RAS. Gatekeepers in

H.323 networks are optional. If they are present in a network, however, terminals and gateways must use their services. The H.323 standards both define mandatory services that the gatekeeper must provide and specify other optional functionality that it can provide.

An optional feature of a gatekeeper is call-signaling routing. Endpoints send call-signaling messages to the gatekeeper, which the gatekeeper routes to the destination endpoints. Alternately, endpoints can send call-signaling messages directly to the peer endpoints. This feature of the gatekeeper is valuable, as monitoring of the calls by the gatekeeper provides better control of the calls in the network. Routing calls through gatekeepers provides better performance in the network, as the gatekeeper can make routing decisions based on a variety of factors, for example, load balancing among gateways.

A gatekeeper is optional in an H.323 system. The services offered by a gatekeeper are defined by RAS and include address translation, admissions control, bandwidth control, and zone management (see *Figure 5*). H.323 networks that do not have gatekeepers may not have these capabilities, but H.323 networks that contain IP–telephony gateways should also contain a gatekeeper to translate incoming E.164 telephone addresses into transport addresses. A gatekeeper is a logical component of H.323 but can be implemented as part of a gateway or MCU.

Figure 5. Gatekeeper Components

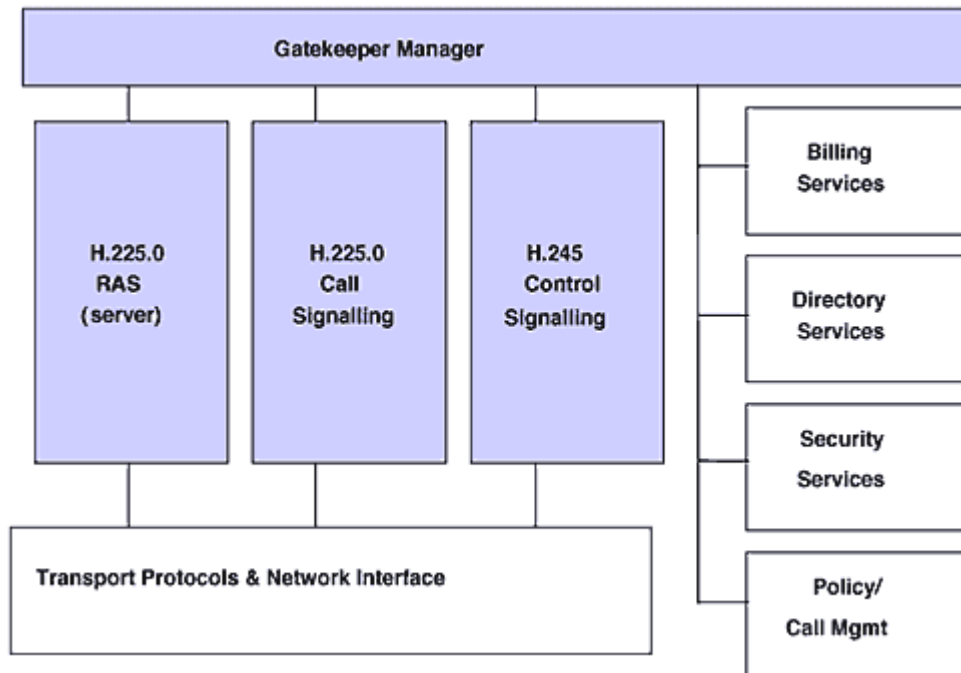

# Mandatory Gatekeeper Functions

## Address Translation

Calls originating within an H.323 network may use an alias to address the destination terminal. Calls originating outside the H.323 network and received by a gateway may use an E.164 telephone number (e.g., 310-442-9222) to address the destination terminal. The gatekeeper translates this E.164 telephone number or the alias into the network address (e.g., 204.252.32:456 for an IP-based network) for the destination terminal. The destination endpoint can be reached using the network address on the H.323 network.

## Admission Control

The gatekeeper can control the admission of the endpoints into the H.323 network. It uses RAS messages, admission request (ARQ), confirm (ACF), and reject (ARJ) to achieve this. Admissions control may be a null function that admits all endpoints to the H.323 network.

## Bandwidth Control

The gatekeeper provides support for bandwidth control by using the RAS messages, bandwidth request (BRQ), confirm (BCF), and reject (BRJ). For instance, if a network manager has specified a threshold for the number of simultaneous connections on the H.323 network, the gatekeeper can refuse to make any more connections once the threshold is reached. The result is to limit the total allocated bandwidth to some fraction of the total available, leaving the remaining bandwidth for data applications. Bandwidth control may also be a null function that accepts all requests for bandwidth changes.

## Zone Management

The gatekeeper provides the above functions—address translation, admissions control, and bandwidth control—for terminals, gateways, and MCUs located within its zone of control. An H.323 zone is defined in *Topic 3*.

# Optional Gatekeeper Functions

## Call-Control Signaling

The gatekeeper can route call-signaling messages between H.323 endpoints. In a point-to-point conference, the gatekeeper may process H.225 call-signaling

messages. Alternatively, the gatekeeper may allow the endpoints to send H.225 call-signaling messages directly to each other.

## Call Authorization

When an endpoint sends call-signaling messages to the gatekeeper, the gatekeeper may accept or reject the call, according to the H.225 specification. The reasons for rejection may include access-based or time-based restrictions, to and from particular terminals or gateways.

## Call Management

The gatekeeper may maintain information about all active H.323 calls so that it can control its zone by providing the maintained information to the bandwidth-management function or by rerouting the calls to different endpoints to achieve load balancing.

# 7. H.225 Registration, Admission, and Status

The H.225 RAS is used between H.323 endpoints (terminals and gateways) and gatekeepers for the following:

- gatekeeper discovery (GRQ)
- endpoint registration
- endpoint location
- admission control
- access tokens

The RAS messages are carried on a RAS channel that is unreliable. Hence, RAS message exchange may be associated with timeouts and retry counts.

## Gatekeeper Discovery

The gatekeeper discovery process is used by the H.323 endpoints to determine the gatekeeper with which the endpoint must register. The gatekeeper discovery can be done statically or dynamically. In static discovery, the endpoint knows the transport address of its gatekeeper a priori. In the dynamic method of gatekeeper discovery, the endpoint multicasts a GRQ message on the gatekeeper's discovery

multicast address: "Who is my gatekeeper?" One or more gatekeepers may respond with a GCF message: "I can be your gatekeeper."

## Endpoint Registration

Registration is a process used by the endpoints to join a zone and inform the gatekeeper of the zone's transport and alias addresses. All endpoints register with a gatekeeper as part of their configuration.

## Endpoint Location

Endpoint location is a process by which the transport address of an endpoint is determined and given its alias name or E.164 address.

## Other Control

The RAS channel is used for other kinds of control mechanisms, such as admission control, to restrict the entry of an endpoint into a zone, bandwidth control, and disengagement control, where an endpoint is disassociated from a gatekeeper and its zone.

# 8. H.225 Call Signaling and H.245 Control Signaling

## H.225 Call Signaling

H.225 call signaling is used to set up connections between H.323 endpoints (terminals and gateways), over which the real-time data can be transported. Call signaling involves the exchange of H.225 protocol messages over a reliable call-signaling channel. For example, H.225 protocol messages are carried over TCP in an IP-based H.323 network.

H.225 messages are exchanged between the endpoints if there is no gatekeeper in the H.323 network. When a gatekeeper exists in the network, the H.225 messages are exchanged either directly between the endpoints or between the endpoints after being routed through the gatekeeper. The first case is direct call signaling. The second case is called gatekeeper-routed call signaling. The method chosen is decided by the gatekeeper during RAS-admission message exchange.

## Gatekeeper-Routed Call Signaling

The admission messages are exchanged between endpoints and the gatekeeper on RAS channels. The gatekeeper receives the call-signaling messages on the call-signaling channel from one endpoint and routes them to the other endpoint on the call-signaling channel of the other endpoint.

## Direct Call Signaling

During the admission confirmation, the gatekeeper indicates that the endpoints can exchange call-signaling messages directly. The endpoints exchange the call signaling on the call-signaling channel.

## H.245 Control Signaling

H.245 control signaling consists of the exchange of end-to-end H.245 messages between communicating H.323 endpoints. The H.245 control messages are carried over H.245 control channels. The H.245 control channel is the logical channel 0 and is permanently open, unlike the media channels. The messages carried include messages to exchange capabilities of terminals and to open and close logical channels.

## Capabilities Exchange

Capabilities exchange is a process using the communicating terminals' exchange messages to provide their transmit and receive capabilities to the peer endpoint. Transmit capabilities describe the terminal's ability to transmit media streams. Receive capabilities describe a terminal's ability to receive and process incoming media streams.

## Logical Channel Signaling

A logical channel carries information from one endpoint to another endpoint (in the case of a point-to-point conference) or multiple endpoints (in the case of a point-to-multipoint conference). H.245 provides messages to open or close a logical channel; a logical channel is unidirectional.

# 9. Connection Procedures

This module describes the steps involved in creating an H.323 call, establishing media communication, and releasing the call. The example network contains two H.323 terminals (T1 and T2) connected to a gatekeeper. Direct call signaling is

assumed. It is also assumed that the media stream uses RTP encapsulation. *Figure 6* illustrates H.323 call establishment.

Figure 6. H.323 Call Establishment

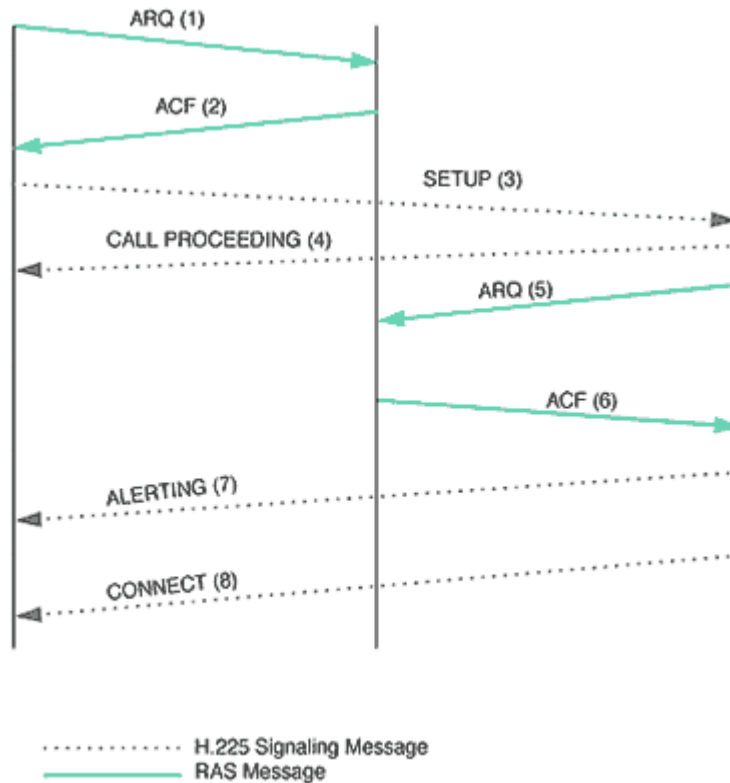

1. T1 sends the RAS ARQ message on the RAS channel to the gatekeeper for registration. T1 requests the use of direct call signaling.
2. The gatekeeper confirms the admission of T1 by sending ACF to T1. The gatekeeper indicates in ACF that T1 can use direct call signaling.
3. T1 sends an H.225 call signaling setup message to T2 requesting a connection.
4. T2 responds with an H.225 call proceeding message to T1.
5. Now T2 has to register with the gatekeeper. It sends an RAS ARQ message to the gatekeeper on the RAS channel.
6. The gatekeeper confirms the registration by sending an RAS ACF message to T2.
7. T2 alerts T1 of the connection establishment by sending an H.225 alerting message.

- Then T2 confirms the connection establishment by sending an H.225 connect message to T1, and the call is established.

Figure 7 illustrates H.323 control signaling flows.

Figure 7. H.323 Control Signaling Flows

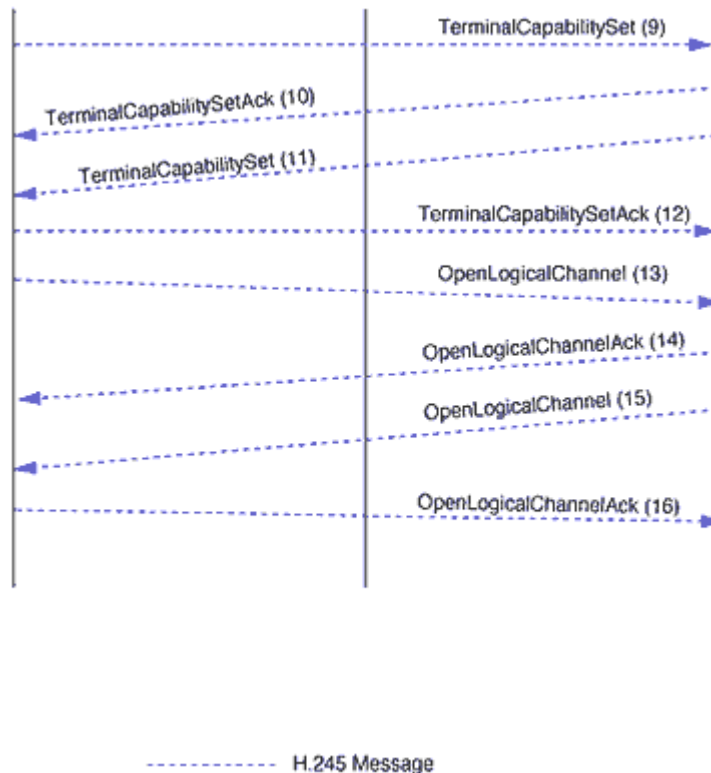

- The H.245 control channel is established between T1 and T2. T1 sends an H.245 TerminalCapabilitySet message to T2 to exchange its capabilities.
- T2 acknowledges T1's capabilities by sending an H.245 TerminalCapabilitySetAck message.
- T2 exchanges its capabilities with T1 by sending an H.245 TerminalCapabilitySet message.
- T1 acknowledges T2's capabilities by sending an H.245 TerminalCapabilitySetAck message.
- T1 opens a media channel with T2 by sending an H.245 openLogicalChannel message. The transport address of the RTCP channel is included in the message.



14. T2 acknowledges the establishment of the unidirectional logical channel from T1 to T2 by sending an H.245 openLogicalChannelAck message. Included in the acknowledge message are the RTP transport address allocated by T2 to be used by the T1 for sending the RTP media stream and the RTCP address received from T1 earlier.
15. Then, T2 opens a media channel with T1 by sending an H.245 openLogicalChannel message. The transport address of the RTCP channel is included in the message.
16. T1 acknowledges the establishment of the unidirectional logical channel from T2 to T1 by sending an H.245 openLogicalChannelAck message. Included in the acknowledging message are the RTP transport address allocated by T1 to be used by the T2 for sending the RTP media stream and the RTCP address received from T2 earlier. Now the bidirectional media stream communication is established.

*Figure 8* illustrates H.323 media stream and media control flows.

Figure 8. H.323 Media Stream and Media Control Flows

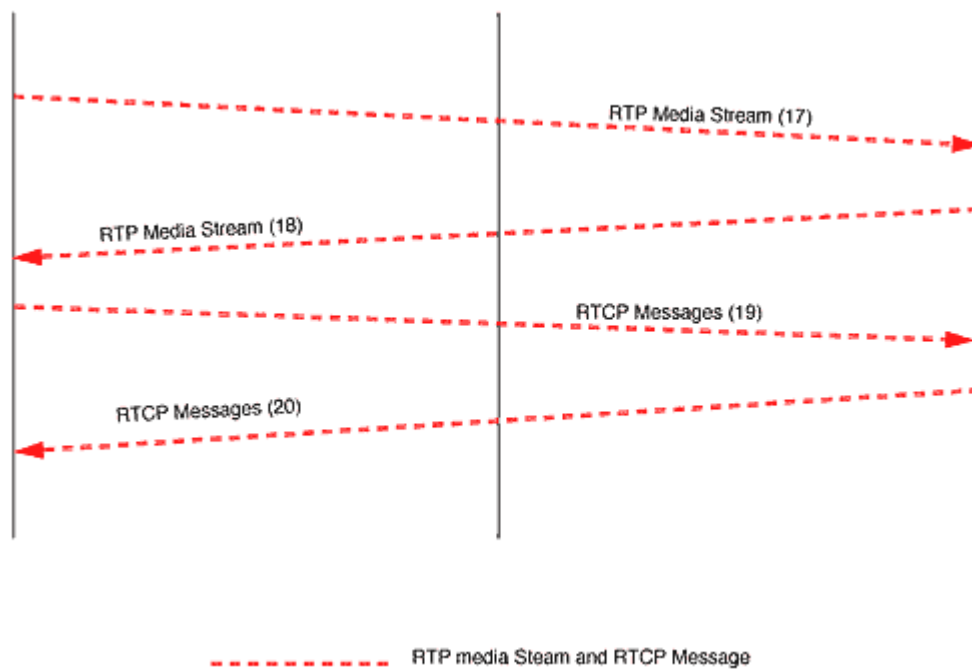

17. T1 sends the RTP encapsulated media stream to T2.
18. T2 sends the RTP encapsulated media stream to T1.
19. T1 sends the RTCP messages to T2.

20. T2 sends the RTCP messages to T1.

Figure 9 illustrates call release flows.

Figure 9. H.323 Call Release

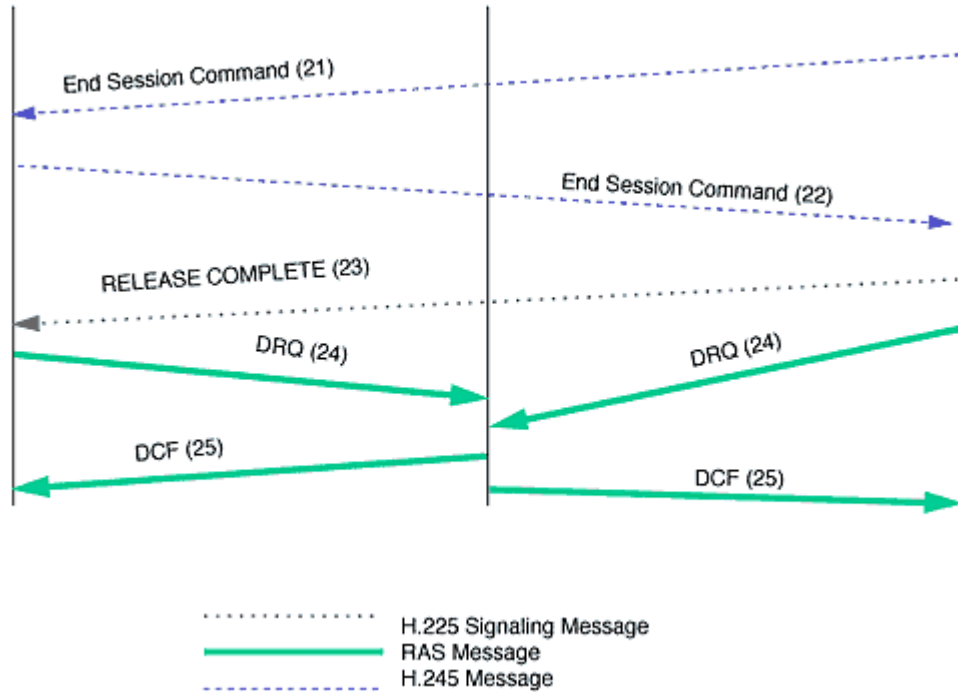

21. T2 initiates the call release. It sends an H.245 EndSessionCommand message to T1.

22. T1 releases the call endpoint and confirms the release by sending an H.245 EndSessionCommand message to T2.

23. T2 completes the call release by sending an H.225 release complete message to T1.

24. T1 and T2 disengage with the gatekeeper by sending an RAS DRQ message to the gatekeeper.

25. The gatekeeper disengages T1 and T2 and confirms by sending DCF messages to T1 and T2.

## 10. Interworking with Other Multimedia Networks

The H.323 protocol is specified so that it interoperates with other networks. The most popular H.323 interworking is IP telephony, when the underlying network of H.323 is an IP network and the interoperating network is SCN (see *Figure 10*). SCN includes PSTN and ISDN networks.

Figure 10. IP Telephony: H.323 Interworking with SCN

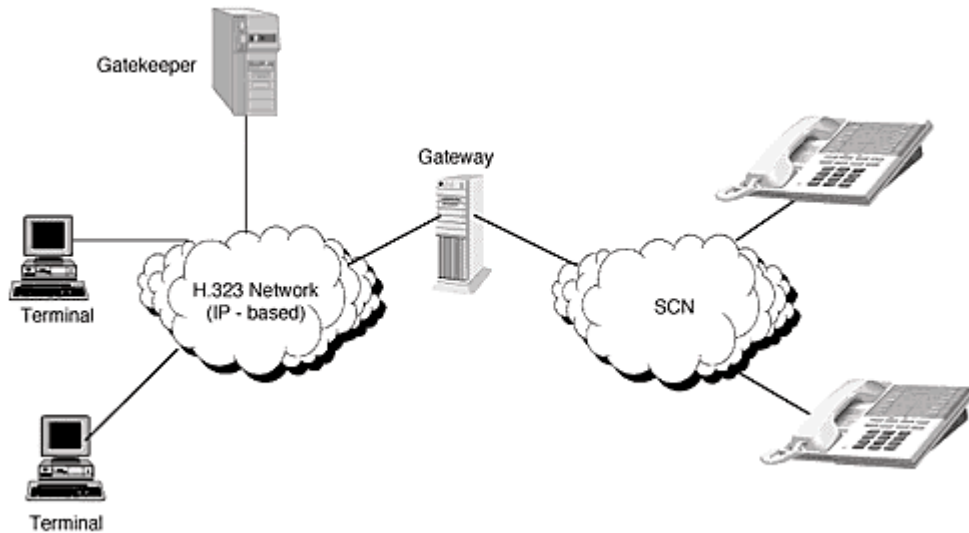

H.323 is compatible with various other H.32x networks. *Figure 11* shows an H.323 zone interworking with all H.32x networks. The ITU-T recommendation H.246 specifies interworking among various H.32x networks.

Figure 11. H.323 Interworking with Other H.32x Networks

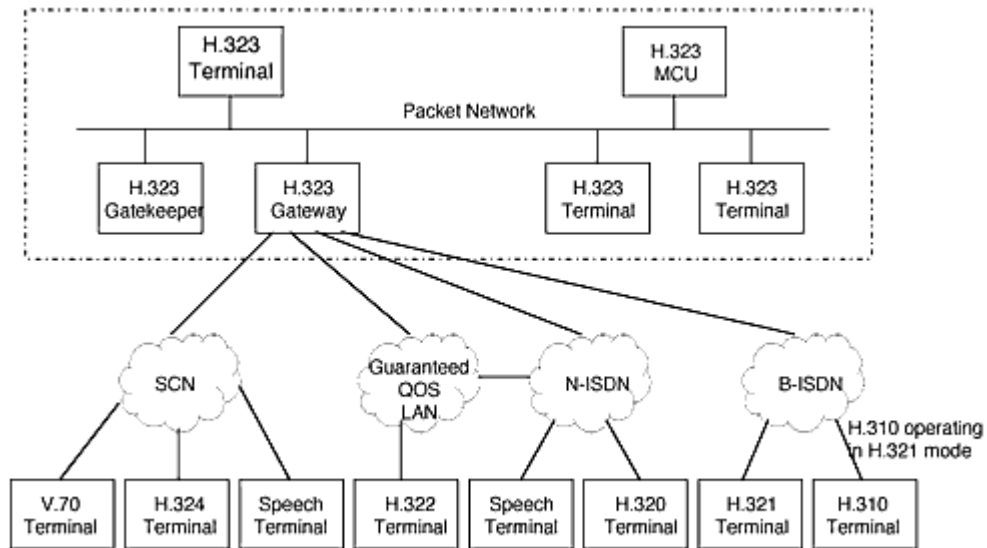

## Self-Test

1. H.323 specifies that H.323 endpoints must support video.
  - a. true
  - b. false
2. An H.323 zone is controlled by one or more gatekeepers.
  - a. true
  - b. false
3. The G.723.1 recommendation specifies audio coding at a rate of 16 kbps.
  - a. true
  - b. false
4. A gatekeeper is an essential component of an H.323 network.
  - a. true
  - b. false

5. H.323 endpoints use RAS protocol to discover their gatekeeper.
  - a. true
  - b. false
6. H.323 endpoints use H.225 to establish media channels.
  - a. true
  - b. false
7. All H.323 calls are signaled by routing through a gatekeeper.
  - a. true
  - b. false
8. An H.323 zone can span across multiple networks.
  - a. true
  - b. false
9. RTP can be defined as \_\_\_\_\_.
  - a. media stream control
  - b. control signaling
  - c. call signaling
  - d. media stream transport
  - e. registration and admission
10. RTCP can be defined as \_\_\_\_\_.
  - a. media stream control
  - b. control signaling
  - c. call signaling
  - d. media stream transport
  - e. registration and admission

11. RAS can be defined as \_\_\_\_\_.

- a. media stream control
- b. control signaling
- c. call signaling
- d. media stream transport
- e. registration and admission

12. H.225 can be defined as \_\_\_\_\_.

- a. media stream control
- b. control signaling
- c. call signaling
- d. media stream transport
- e. registration and admission

13. H.245 can be defined as \_\_\_\_\_.

- a. media stream control
- b. control signaling
- c. call signaling
- d. media stream transport
- e. registration and admission

14. H.323 can be defined as \_\_\_\_\_.

- a. multimedia services over B-ISDN
- b. multimedia services over guaranteed QoS networks
- c. multimedia services over packet networks
- d. multimedia services over SCN
- e. multimedia services over ISDN

15. H.320 can be defined as \_\_\_\_\_.
- a. multimedia services over B-ISDN
  - b. multimedia services over guaranteed QoS networks
  - c. multimedia services over packet networks
  - d. multimedia services over SCN
  - e. multimedia services over ISDN
16. H.321 can be defined as \_\_\_\_\_.
- a. multimedia services over B-ISDN
  - b. multimedia services over guaranteed QoS networks
  - c. multimedia services over packet networks
  - d. multimedia services over SCN
  - e. multimedia services over ISDN
17. H.322 can be defined as \_\_\_\_\_.
- a. multimedia services over B-ISDN
  - b. multimedia services over guaranteed QoS networks
  - c. multimedia services over packet networks
  - d. multimedia services over SCN
  - e. multimedia services over ISDN
18. H.324 can be defined as \_\_\_\_\_.
- a. multimedia services over B-ISDN
  - b. multimedia services over guaranteed QoS networks
  - c. multimedia services over packet networks
  - d. multimedia services over SCN
  - e. multimedia services over ISDN

19. H.310 can be defined as \_\_\_\_\_.
- a. multimedia services over B-ISDN
  - b. multimedia services over guaranteed QoS networks
  - c. multimedia services over packet networks
  - d. multimedia services over SCN
  - e. multimedia services over ISDN

## Correct Answers

1. H.323 specifies that H.323 endpoints must support video.
- a. true
  - b. false**
- See Topic 4.
2. An H.323 zone is controlled by one or more gatekeepers.
- a. true
  - b. false**
- See Topic 3.
3. The G.723.1 recommendation specifies audio coding at a rate of 16 kbps.
- a. true
  - b. false**
- See Topic 4.
4. A gatekeeper is an essential component of an H.323 network.
- a. true
  - b. false**
- See Topic 7.



5. H.323 endpoints use RAS protocol to discover their gatekeeper.

a. **true**

b. false

See Topic 9.

6. H.323 endpoints use H.225 to establish media channels.

a. true

**b. false**

See Topic 10.

7. All H.323 calls are signaled by routing through a gatekeeper.

a. true

**b. false**

See Topic 9.

8. An H.323 zone can span across multiple networks.

a. true

b. false

See Topic 3.

9. RTP can be defined as \_\_\_\_\_.

a. media stream control

b. control signaling

c. call signaling

**d. media stream transport**

e. registration and admission

See Topic 4.

10. RTCP can be defined as \_\_\_\_\_.

**a. media stream control**

- b. control signaling
- c. call signaling
- d. media stream transport
- e. registration and admission

See Topic 4.

11. RAS can be defined as \_\_\_\_\_.

- a. media stream control
- b. control signaling
- c. call signaling
- d. media stream transport
- e. registration and admission**

See Topic 4.

12. H.225 can be defined as \_\_\_\_\_.

- a. media stream control
- b. control signaling
- c. call signaling**
- d. media stream transport
- e. registration and admission

See Topic 4.

13. H.245 can be defined as \_\_\_\_\_.

- a. media stream control
- b. control signaling**
- c. call signaling
- d. media stream transport
- e. registration and admission

See Topic 4.

14. H.323 can be defined as \_\_\_\_\_.

- a. multimedia services over B-ISDN
- b. multimedia services over guaranteed QoS networks
- c. multimedia services over packet networks**
- d. multimedia services over SCN
- e. multimedia services over ISDN

See Topic 1.

15. H.320 can be defined as \_\_\_\_\_.

- a. multimedia services over B-ISDN
- b. multimedia services over guaranteed QoS networks
- c. multimedia services over packet networks
- d. multimedia services over SCN
- e. multimedia services over ISDN**

See Topic 1.

16. H.321 can be defined as \_\_\_\_\_.

- a. multimedia services over B-ISDN**
- b. multimedia services over guaranteed QoS networks
- c. multimedia services over packet networks
- d. multimedia services over SCN
- e. multimedia services over ISDN

See Topic 1.

17. H.322 can be defined as \_\_\_\_\_.

- a. multimedia services over B-ISDN
- b. multimedia services over guaranteed QoS networks**

- c. multimedia services over packet networks
- d. multimedia services over SCN
- e. multimedia services over ISDN

See Topic 1.

18. H.324 can be defined as \_\_\_\_\_.

- a. multimedia services over B–ISDN
- b. multimedia services over guaranteed QoS networks
- c. multimedia services over packet networks
- d. multimedia services over SCN**
- e. multimedia services over ISDN

See Topic 1.

19. H.310 can be defined as \_\_\_\_\_.

- a. multimedia services over B–ISDN**
- b. multimedia services over guaranteed QoS networks
- c. multimedia services over packet networks
- d. multimedia services over SCN
- e. multimedia services over ISDN

See Topic 1.

## Glossary

**B–ISDN**  
broadband ISDN

**CODEC**  
coder/decoder

**EN**  
enterprise network

**IN**

intelligent network

**IP**

Internet protocol

**IPX**

Internet packet exchange

**ISDN**

integrated services digital network

**ITU-T**

International Telecommunications Union (telecommunications sector)

**LAN**

local-area network

**MAN**

metropolitan-area network

**MCU**

multipoint control unit

**PC**

personal computer

**PSTN**

public switched telephone network

**QoS**

quality of service

**RAS**

registration, admission, and status

**RTP**

real-time transport protocol

**RTCP**

real-time transport control protocol

**SCN**

switched circuit network

**SS7**

signaling system 7

**TCP**

transport control protocol

**UDP**

user datagram protocol

**WAN**

wide-area network